



QAD Enterprise Applications

# Training Guide **QAD Configurator**

70-3126-5.5  
QAD Enterprise Applications  
Configurator 5.5  
March 2014

This document contains proprietary information that is protected by copyright and other intellectual property laws. No part of this document may be reproduced, translated, or modified without the prior written consent of QAD Inc. The information contained in this document is subject to change without notice.

QAD Inc. provides this material as is and makes no warranty of any kind, expressed or implied, including, but not limited to, the implied warranties of merchantability and fitness for a particular purpose. QAD Inc. shall not be liable for errors contained herein or for incidental or consequential damages (including lost profits) in connection with the furnishing, performance, or use of this material whether based on warranty, contract, or other legal theory.

QAD and MFG/PRO are registered trademarks of QAD Inc. The QAD logo is a trademark of QAD Inc.

Designations used by other companies to distinguish their products are often claimed as trademarks. In this document, the product names appear in initial capital or all capital letters. Contact the appropriate companies for more information regarding trademarks and registration.

Copyright ©2014 by QAD Inc.

Configurator\_TG\_v70-3126-5.5.pdf/c6s/p9w

**QAD Inc.**

100 Innovation Place  
Santa Barbara, California 93108  
Phone (805) 566-6000  
<http://www.qad.com>

# Contents

<b>Change Summary</b> .....	<b>vii</b>
<b>About This Course</b> .....	<b>1</b>
Course Description .....	2
Virtual Environment Information .....	2
Additional Resources .....	3
QAD Learning Center .....	3
QAD Document Library .....	3
QAD Support .....	3
<b>Chapter 1 Introduction to QAD Configurator</b> .....	<b>5</b>
Business Considerations .....	6
Manufacturing Strategies .....	7
Variety and Volume Relationships .....	9
QAD Configurator Key Features .....	10
QAD Configurator Key Benefits .....	11
Basic Configurator Workflow .....	12
Integration with QAD EA .....	13
QAD Configurator Workspace .....	14
Performance Check .....	15
<b>Chapter 2 System Setup</b> .....	<b>17</b>
Scenario .....	18
QAD Enterprise Applications Setup .....	19
QAD Configurator Setup .....	19
Configurator Control .....	19
Exercise 1: Configurator Control .....	19
Master Group Maintenance .....	20
Exercise 2: Master Group Maintenance .....	20
Configurable Item Maintenance .....	22
Exercise 3: Configurable Item Maintenance .....	22
<b>Chapter 3 Sales Configuration</b> .....	<b>25</b>
Question Type Maintenance .....	26

Exercise 4: Question Type Maintenance .....	26
Functional Group Maintenance .....	26
Exercise 5: Functional Group Maintenance .....	28
Variable and Variable Options Definition .....	29
Exercise 6: Variable Maintenance .....	29
Feature and Feature Options Definition .....	33
Feature Details .....	33
Feature Options .....	35
Scenario: Dealing with a Large Number of Feature Options .....	36
Exercise 7: Feature Maintenance .....	37
Feature Sequence Maintenance .....	37
Exercise 8: Feature Sequence Maintenance .....	38
Sales Configuration Rules .....	39
General Rule Maintenance .....	39
Exercise 9: General Rule Maintenance .....	40
Rule Group Maintenance .....	42
Exercise 10: Rule Group Maintenance .....	42
Item Rule Maintenance .....	43
Exercise 11: Item Rule Maintenance: Link Rule-Group .....	43
Exercise 12: Item Rule Maintenance: Create Item Rule .....	44
Remarks and Exercises on Rule Modes .....	45
Exercise 13: General Rule Maintenance: Advanced Mode .....	45
Exercise 14: Item Rule Maintenance: Free Format Mode .....	46
Rule Tables .....	47
General Rule Table Maintenance .....	49
Exercise 15: General Rule Table Maintenance — Manual entry .....	49
Exercise 16: General Rule Table Maintenance: Auto-Generation .....	51
Item Rule Table Maintenance .....	52
Exercise 17: Item Rule Table Maintenance .....	53
Configuration Key Maintenance .....	54
Exercise 18: Configuration Key Maintenance .....	54

**Chapter 4 Product Configuration .....57**

Product Configuration Rules .....	58
Variant Item Number Rule Maintenance .....	58
Exercise 19: Variant Item Number Rule Maintenance .....	58
Variant Item Data Rule Maintenance .....	59
Exercise 20: Variant Item Data Rules Maintenance .....	59
General Product Structure Rule Maintenance .....	59
Exercise 21: General Product Structure Rule Maintenance .....	60
Variant Product Structure Rule Maintenance .....	60
Exercise 22: Variant Product Structure Rule Maintenance .....	61
Variant Routing Rule Maintenance .....	64

Exercise 23: Variant Routing Rule Maintenance . . . . .	64
Exercise 24: Variant Routing Maintenance . . . . .	65
Element Roll-Up Rule Maintenance . . . . .	66
Exercise 25: Element Roll-up Rule Maintenance . . . . .	67
Configuration Analyzer/Cross Validation Analyzer . . . . .	68
Exercise 26: Configuration Analyzer and Cross Validation Analyzer . . . . .	68
<b>Chapter 5 Configurator Questionnaire . . . . .</b>	<b>71</b>
Questionnaire Sequence Maintenance . . . . .	72
Exercise 27: Questionnaire Sequence Maintenance . . . . .	72
Exercise 28: Configurator Questionnaire . . . . .	72
Exercise 29: Verifying the structure of the Variant Item . . . . .	75
Exercise 30: Starting the Questionnaire from Sales Order Maintenance . . . . .	76
Exercise 31: Examining the Questionnaire . . . . .	76
Exercise 32: Show Existing Configurations Option . . . . .	77
<b>Chapter 6 Pricing . . . . .</b>	<b>79</b>
Pricing: Use Pricing Without Pricing Rules . . . . .	81
Exercise 33: Use Pricing Without Pricing Rules . . . . .	81
Pricing: Use Pricing With Pricing Rules . . . . .	84
Exercise 34: Pricing with Pricing Rules . . . . .	84
Pricing: Numeric List Example . . . . .	85
Exercise 35: Pricing With Numeric Lists . . . . .	85
Pricing: Allow Net Price Changes . . . . .	86
Exercise 36: Net Price Changes . . . . .	86
Pricing: Manual Price List Selection . . . . .	87
Exercise 37: Manual Price List Selection . . . . .	87
Pricing: Store All Pricing Info . . . . .	88
<b>Chapter 7 Additional Subjects . . . . .</b>	<b>89</b>
Configurable Item Data Copy . . . . .	90
Exercise 38: Configurable Item Data Copy . . . . .	90
Displaying Warning Messages in the Questionnaire . . . . .	91
Exercise 39: Warning Message in the Questionnaire . . . . .	92
Variant Item-Site Records . . . . .	93
Exercise 40: Variant Item-Site Records . . . . .	93
Element Variables . . . . .	95
Exercise 41: Element Variable and Internal Entities . . . . .	95
External Entity Maintenance . . . . .	96
Exercise 42: External Entity Maintenance . . . . .	96
External Entity Rule Maintenance . . . . .	97
Configurable Item Maintenance Cost Roll-Up . . . . .	98

Element Roll-Up .....	98
Manual Configuration Maintenance .....	98
Configuration Rebuild .....	99
Exercise 43: Configuration Rebuild .....	99
Forecasting Configurable Items .....	100
Exercise 44: Forecasting a Configurable Item .....	101
Deleting and Archiving Configurations .....	102
Batch Compiler .....	102
Rule Table Accelerator .....	103
Configurator Reports .....	103
Exercise 45: Configurator Reports .....	103
<b>Appendix A QAD Enterprise Applications Setup .....</b>	<b>105</b>
QAD Enterprise Applications Setup .....	106
<b>Product Information Resources .....</b>	<b>109</b>

# Change Summary

The following table summarizes significant differences between this document and the last published version.

<b>Date/Version</b>	<b>Description</b>	<b>Reference</b>
March 2014/5.5	Updated screen shots	---
	Added Master Comment Maintenance to Integration with QAD EA	Page 13
	Updated the information on Functional Group Maintenance	Page 26
	Updated the information on Variable and Variable Options Definition	Page 29
	Updated the information on Feature and Feature Options Definition	Page 33
	Added a scenario about how to deal with a large number of feature options	Page 36
	Updated the exercise for General Rule Maintenance	Page 40
	Updated the exercises for Item Rule Maintenance	Page 43, Page 44, Page 45, and Page 46
	Updated the exercises for General Rule Table Maintenance	Page 49 and Page 51
	Updated the information for Configuration Questionnaire	Page 74
	Updated the exercises for Pricing	Page 84 and Page 85
	Added a note to Exercise 38: Configure Item Data Copy	Page 90
	Updated the information on Displaying Warning Message in the Questionnaire	Page 91
	Added a note to Variant Item-Site Records	Page 93
October 2013/5.4.1	Added Feature Based Pricing	Page 33
April 2013/5.4	Consistency edit	---
October 2012/5.3.1	Rebranded for QAD Configurator 5.3.1	---
June 2012/5.3	Rebranded for QAD Configurator 5.3	---



# **About This Course**

## Course Description

This course is designed to cover the basics of using QAD Configurator to configure customizable products to meet specific customers' requirements.

The course includes:

- An introduction to the QAD Configurator product.
- Instructions on how to perform data and system setup prior to using QAD Configurator.
- Instructions on how to implement the sales configuration process.
- Instructions on how to implement the product configuration process.
- Instructions on how to use the guided sales process to configure products.
- Activities and exercises throughout the course

### Course Objectives

- Understand the underlying key business concepts behind QAD Configurator.
- Use Configurator to customize configurable products.

### Audience

The audience for this course includes:

- Engineers
- Customer service representatives
- Implementation consultants
- Members of implementation teams

### Prerequisites

- Basic knowledge of QAD Enterprise Applications (QAD EA) as it is used in the industry today.
- Knowledge of QAD Enterprise Applications product structures and routing functionality
- Working knowledge of the manufacturing industry in general

**Note** If you are not familiar with QAD EA, read *User Guide: Introduction to QAD Enterprise Applications*.

### Course Credit and Scheduling

This course is typically taught in four days.

### Virtual Environment Information

The hands-on exercises in this book should be used with the latest Enterprise Edition with Addons learning environment in the 10USA > 10USACO workspace. When prompted to log in, specify *demo* for user ID and *qad* for password.

## Additional Resources

If you encounter questions on QAD software that are not addressed in this book, several resources are available. The QAD corporate Web site provides product and company overviews. From the main site, you can access the QAD Learning or Support site and the QAD Document Library. Access to some portions of these sites depends on having a registered account.

<http://www.qad.com/>

### QAD Learning Center

To view available training courses, locations, and materials, use the QAD Learning Center. Choose Education under the Services tab to access this resource. In the Learning Center, you can reserve a learning environment if you want to perform self-study and follow a training guide on your own.

### QAD Document Library

To access release notes, user guides, training guides, and installation and conversion guides by product and release, visit the QAD Document Library. Choose Document Library under the Support tab. In the QAD Document Library, you can view HTML pages online, print specific pages, or download a PDF of an entire book.

To find a resource, you can use the navigation tree on the left or use a powerful cross-document search, which finds all documents with your search terms and lets you refine the search by book type, product suite or module, and date published.

### QAD Support

Support also offers an array of tools depending on your company's maintenance agreement with QAD. These include the Knowledgebase and QAD Forums, where you can post questions and search for topics of interest. To access these, choose Visit Online Support Center under the Support tab.



# Introduction to QAD Configurator

- What is QAD Configurator?
- What does QAD Configurator do?
- What benefits does QAD Configurator provide?
- What manufacturing strategies can QAD Configurator most likely help you implement?
- What is the relationship between QAD Configurator and QAD Enterprise Applications?
- What does the QAD Configurator workspace look like?

Read this chapter and you can:

- Describe the main features of QAD Configurator
- Describe the key benefits of using QAD Configurator
- Identify the manufacturing environments QAD Configurator best works in
- Understand how QAD Configurator is integrated with QAD Enterprise Applications
- Describe the basic Configurator workflow
- Know your way around the QAD Configurator workspace

## Business Considerations

### Business Considerations



More Customizations



Less Inventory



Less Delivery Lead Time



In this increasingly competitive market, many manufacturing companies are seeking to address three key issues to increase customer satisfaction and gain a competitive edge:

- Meet customers' increasingly varied and personalized demands
- Minimize inventory
- Minimize delivery lead time

To tailor products to customers' needs, a manufacturer must possess the capability and flexibility to accept customized orders and configure products according to specific requirements.

To keep inventory as low as possible, use a postponement strategy to delay manufacturing or assembling products until customer orders are received.

To shorten delivery lead time, the ability to swiftly convert customers' requirements into manufacturing requirements is crucial.

## Manufacturing Strategies

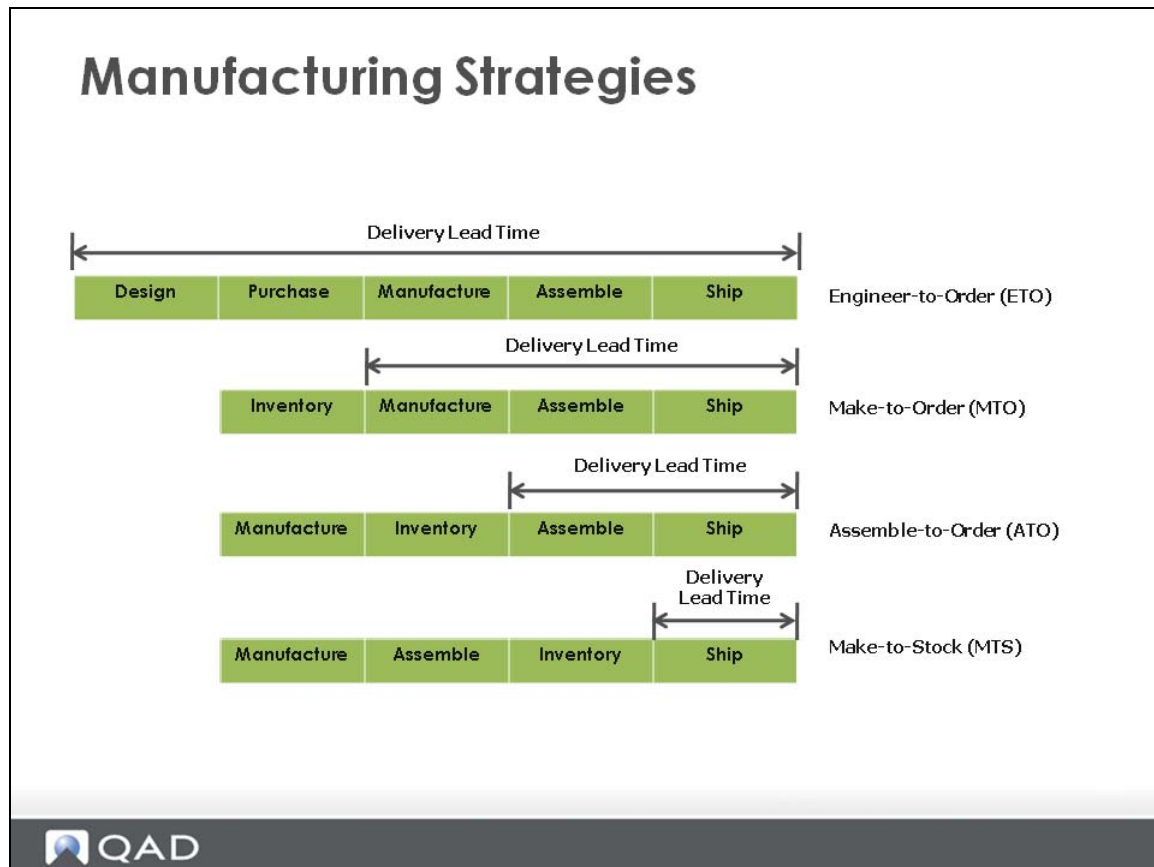

A highly market-oriented company focuses on meeting or exceeding customer expectations. In such a company all functions must contribute toward a winning strategy. Thus, operations must have a strategy that allows it to supply the needs of the marketplace and provide fast on-time delivery.

From the supplier's perspective, delivery lead time is the time from placing an order to the delivery of the product. From the customer's perspective, it can also include time for order preparation and transmittal. Customers want delivery lead time to be as short as possible, and manufacturing must design a corresponding strategy.

There are four basic strategies: engineer-to-order, make-to-order, assemble-to-order, and make-to-stock. These strategies can influence delivery lead time, customer involvement in the product design, and inventory state.

**Engineer-to-order** means that the customer's specifications require unique engineering design or significant customization. Usually the customer is highly involved in the product design: Inventory is not purchased until needed for manufacturing. Delivery lead time is long because it includes not only purchase lead time, but design lead time as well.

**Make-to-order** means that the manufacturer does not start to make the product until a customer's order is received. The final product is normally made from standard items but can include custom-designed components as well. Delivery lead time is reduced because there is little design time required and inventory is held as raw material.

**Assemble-to-order** means that the product is made from standard components that the manufacturer can inventory and assemble according to a customer order. Delivery lead time is reduced further because there is no design time needed and inventory is held ready for assembly. Customer involvement in the design of the product is limited to selecting the component part options needed.

**Make-to-stock** means that the supplier manufactures the goods and sells from finished goods inventory. Delivery lead time is shortest. The customer has little direct involvement in the product design.

**Question** Can you think of some examples for each of these four manufacturing environments?

---

---

---

---

## Variety and Volume Relationships

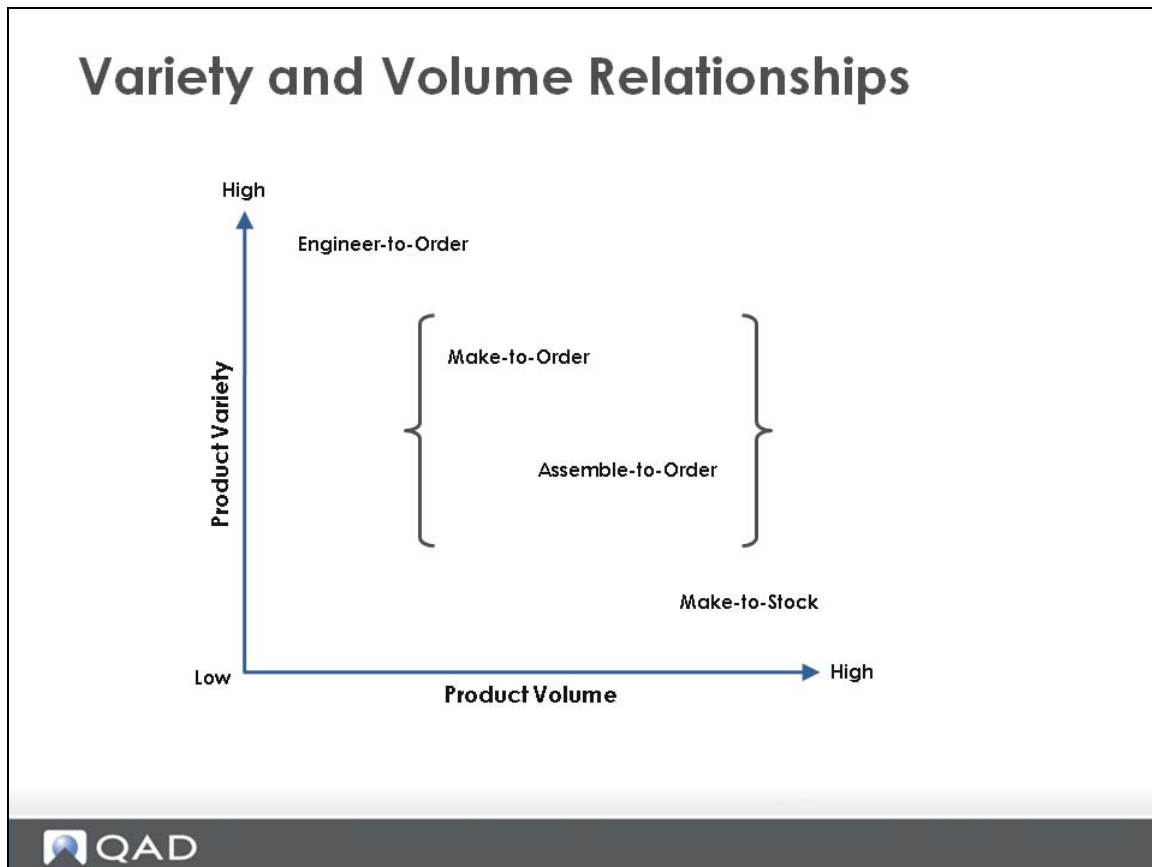

The relationship of the Variety/Volume matrix is between the volume and variety of products produced and the particular manufacturing strategy chosen to accomplish the production.

As you can see, if you adopt the make-to-order and assemble-to-order strategies, there can be many product varieties as well as large volumes. Ask three key questions for the strategies to be successful:

- How can you effectively create and maintain all possible product configurations?
- How can you efficiently collect customers' specific requirements?
- How can you swiftly translate customers' requirements into manufacturing requirements?

QAD Configurator can help you answer these questions.

## QAD Configurator Key Features

### Configurator Key Features

- Powerful and flexible questionnaire design
- Questionnaire-guided sales for customizable products
- Powerful and flexible price calculations
- Powerful and flexible product configuration rule definition capabilities
- Instant conversion of customer requirements into manufacturing requirements
- Seamless integration with QAD Enterprise Applications



QAD Configurator is a product configuration and guided selling tool. It allows make-to-order and assemble-to-order companies to quickly and efficiently create sales orders based on specific customer requirements, and to fulfill complex, customized products and services. It is an add-on module to QAD Enterprise Applications and provides flexible and powerful product configuration and computer-aided order entry capabilities.

QAD Configurator works for manufacturing companies who produce products that are highly configurable or are routinely customized to meet the unique needs of their customers. By seamlessly integrating into the order entry process, QAD Configurator ensures complete and valid product configuration during order entry. It instantaneously translates customers' unique product requests into quotations, sales orders, bills of material, and routings.

## QAD Configurator Key Benefits

### Configurator Key Benefits

- Bridges the information and knowledge gap between sales and engineering
- Easily configure products to meet customers' specific requirements
- Streamlined sales order and quotation entry process for configurable products
- Reduces lead time to fulfill orders for configured products
- Reduced error rates



QAD Configurator effectively bridges the information and knowledge gap between product engineering and sales. It allows sales personnel to access the most current product data, while engineering personnel maintains the product data. And sales personnel can enter orders with complex configurations based on specific requirements from customers.

## Basic Configurator Workflow

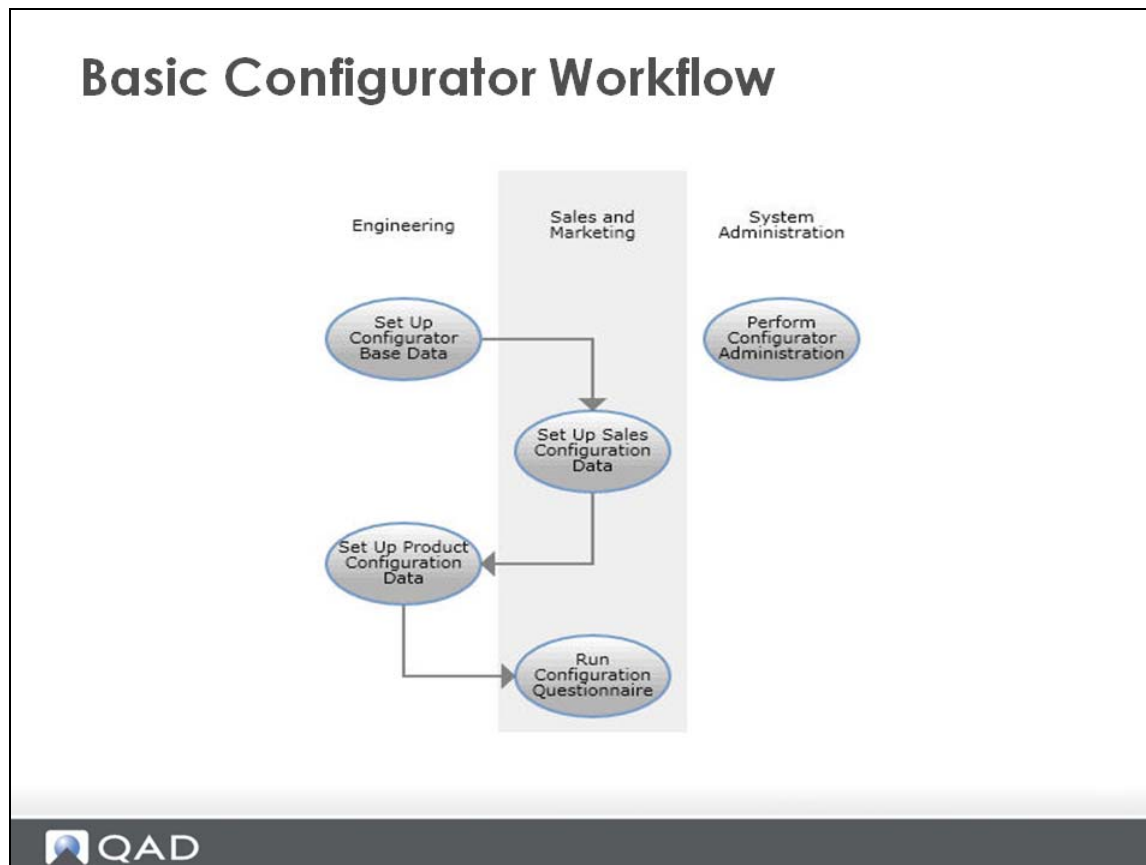

- **System Setup**

Before using QAD Configurator, perform system setup including setting up data in QAD Enterprise Applications and in Configurator.

- **Sales Configuration**

Sales personnel do the following:

- maintain variables and features that define configurable product characteristics
- designate how to present features as questions in the guided sales questionnaire
- set up sales configuration rules to ensure data collected from the questionnaire is valid

- **Product Configuration**

Engineering personnel define product configuration rules that translate feature data collected from questionnaires into product structures and routings of configured products.

- **Guided Sales**

Sales personnel run the questionnaire during order or quotation entry to configure products to meet specific customer needs. Data collected in this guided sales process identify new product configurations and translate new customer requirements into new product structures and routings.

- **Administration**

Use a range of administrative functions to maintain the system for optimal performance.

## Integration with QAD EA

### Integration with QAD Enterprise Applications

- Integrated with the following QAD Enterprise Applications functions:
  - Sales Quote Maintenance (7.12.1)
  - Sales Order Maintenance (7.1.1)
  - Item Master Maintenance (1.4.1)
  - Product Structure Maintenance (13.5)
  - Routing Maintenance (14.13.1)
  - Item-Site Inventory Data Maintenance (1.4.16)
  - Item-Site Planning Maintenance (1.4.17)
  - Item-Site Cost Maintenance (1.4.18)
  - Master Comment Maintenance (2.1.12)



- You can access QAD Configurator functions by using either the Menu Search field or the menu tree in the Applications pane in the QAD .NET user interface.
- After you install QAD Configurator, QAD Configurator functions are grouped under Customer Management|Configurator by default in QAD Enterprise Applications. For earlier versions of QAD EA, QAD Configurator functions can be found under Distribution|Configurator.
- The Questionnaire is automatically launched when you select a configurable item in the order line in Sales Order Maintenance (7.1.1) or Sales Quote Maintenance (7.12.1) in the .NET UI.

## QAD Configurator Workspace

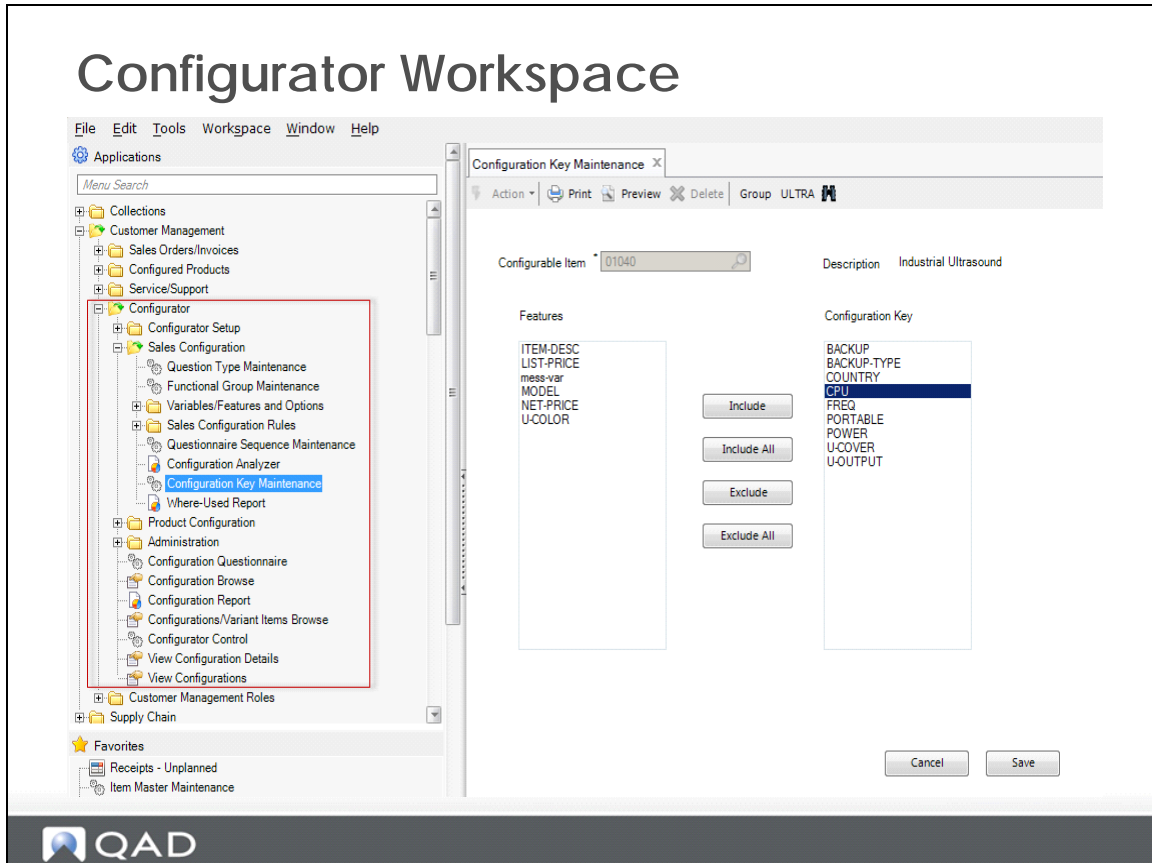

QAD Configurator is embedded in the application area of the QAD .NET user interface. Thus it is consistent with the rest of the QAD Enterprise Applications in terms of look and feel and navigation.

## Performance Check

- 1 QAD Configurator is NOT suitable for companies manufacturing which of the following products?
  - A. Cars
  - B. Hamburgers
  - C. Personal computers
  - D. DIY furniture
- 2 QAD Configurator lets you do all of the following EXCEPT:
  - A. Design questionnaires
  - B. Collect customers' requirements
  - C. Generate generic routings
  - D. Forecast customers' demands
- 3 Which user interface does QAD Configurator support?
  - A. CHUI
  - B. Windows GUI
  - C. Web
  - D. QAD .NET UI
- 4 QAD Configurator provides the following benefits EXCEPT:
  - A. Sales and engineering data consolidation
  - B. Easy product configuration
  - C. Streamlined order processing for configurable products
  - D. Reduced delivery lead time
- 5 Engineering personnel define rules that translate feature data collected from questionnaires into product structures and routings of configured products in:
  - A. System setup
  - B. Sales configuration
  - C. Product configuration
  - D. Guided sales questionnaire



Chapter 2

# **System Setup**

## Scenario

The Industrial Ultrasound used in this training is a configurable item that is made to order out of standardized components.

With QAD Configurator, the configurable product structure contains all possible component items for configuration. When a variant is created, the variant product structure contains a subset of the components of the generic product structure.

The following diagram shows the configurable product structure of the Industrial Ultrasound. In this product structure 50020 is also a configurable item.

Parent Item/BOM Code: 01040		Industrial Ultrasound		EA
As Of: 02/01/11		Levels:		Rev:
PCO Number:	ID:	Domain:	Output: PAGE	
Level	Component Item	Description	Quantity Per	UM Ph T Iss
Parent	01040	Industrial Ultrasound		EA
1	02003	Standard Connector	2.0	EA
.2	62050	Beryllium Copper	0.0001	RL
.2	62050	Beryllium Copper	0.0001	RL
.2	90031	Packaging	2.0	EA
1	50001	Probe Unit - 10 Mhz	1.0	EA
.2	02003	Standard Connector	1.0	EA
..3	62050	Beryllium Copper	0.0001	RL
..3	62050	Beryllium Copper	0.0001	RL
..3	90031	Packaging	2.0	EA
.2	60004	Transducer - 10 Mhz	1.0	EA
1	50002	Probe Unit - 500 kHz	1.0	EA
.2	02004	Laptop Connector	1.0	EA
..3	62050	Beryllium Copper	0.0001	RL
..3	62050	Beryllium Copper	0.0001	RL
..3	90031	Packaging	2.0	EA
.2	60016	Transducer -500 kHz	1.0	EA
1	50020	Industrial Housing	1.0	EA
.2	60060	White Paint	1.0	GA
.2	60061	Black Paint	1.0	GA
.2	60062	Paint, Other	1.0	GA
.2	60090	Small Sheet Steel 80X 120 cm	1.0	EA
.2	60091	Large Sheet Steel 160 x 200 cm	1.0	EA
.2	60093	Stainless Steel Sheet	1.0	EA
1	60003	Keyboard	1.0	EA
1	60008	Printer	1.0	EA
1	60015	Keyboard Cover	1.0	EA
1	60020	Cooling Fan	1.0	EA
1	60021	Battery Backup, Alkaline	4.0	EA
1	60022	Battery Backup, Lithium	4.0	EA
1	60050	Base Unit / CPU	1.0	EA
1	60052	High Performance CPU	1.0	EA
1	60080	Power Cord - UK	1.0	EA
1	60081	Power Cord - US	1.0	EA
1	60082	Power Cord - Australia	1.0	EA
1	60083	Power Cord - Universal	1.0	EA
1	60088	Power Converter-Standard	1.0	EA
1	60089	Power Converter - Smart	1.0	EA
1	90093	Shipping Carton	1.0	EA

In this scenario, use QAD Configurator to configure the product structure for a variant and the corresponding routing.

## QAD Enterprise Applications Setup

The Configurator training is based on the following QAD Enterprise Applications data:

- Items
- Product Structures
- Work Center and Routings

This data is already in the system and is part of the QMI set of data. Refer to the appendix and review this data.

## QAD Configurator Setup

Start QAD Configurator from the QAD Enterprise Applications menu by choosing menu Configurator. You can also run the Configurator using the process maps.

### Configurator Control

Use Configurator Control to define the system settings.

### Exercise 1: Configurator Control

Run Configurator Control to verify the default settings for using QAD Configurator or to enter new ones. Make sure that the entries are correct.

The screenshot shows the 'Configurator Control' web application interface. It is divided into several sections:

- System Control:** Contains two text input fields: 'Appserver Questionnaire Directory' with the value '/home/demo/quest' and 'Appserver Variant Directory' with the value '/home/demo/var'.
- Variant Level:** Contains two rows of radio buttons:
  - 'SQ Maintenance:' with 'Product Structure' selected and 'Off' unselected.
  - 'SO Maintenance:' with 'Product Structure' selected and 'Off' unselected.
- Configurator Questionnaire:** Contains a checked checkbox labeled 'Pegging for Re-Analyze'.
- WebSpeed Settings:** Contains four text input fields:
  - 'WebSpeed URL:' with the value 'http://qaddemo/cgi-bin/wspd.cgi.sh/WService=cpd\_WSlive'.
  - 'Web URL:' with the value 'http://qaddemo/qadcpd'.
  - 'Web Timeout:' with the value '100000'.
  - 'Property Path:' with the value '/dt01/qadapps/cpd'.

## Master Group Maintenance

When you have defined different groups, you can categorize information in QAD Configurator. In other words, you can store and maintain various models separately, such as by product features, sales configuration rules, or product configuration rules.

When you create a group, you can also set up various defaults and settings that control the way QAD Configurator operates within this group only. For example, you can set up the default number of digits and decimals that are used for numeric variables and features created in the group. You can select a default rounding method. You can specify whether single-level or multi-level product structures are used. And you can specify whether to generate variant routings for products configured in a group.

### Exercise 2: Master Group Maintenance

Use Master Group Maintenance to verify the default settings for using QAD Configurator or to enter them. Make sure that your entries are consistent with the data in the following table.

Field	Entry
Master Group	ULTRA
Description	Ultrasound Products
<b>General Settings</b>	
Allow Multi-Level Product Structure	Selected
Create Variant Routings	Selected
Use Standard Options	Selected
UOM	EA
<b>Default Numeric Format Settings</b>	

Field	Entry
Digits	8
Decimals	0
Allow Negative Values	Not selected
Rounding Method	Standard

Configurable Item Selection	
P/M Type	Select all check boxes
Phantom Item	Selected
Effective Only	Selected

**Note** Many QAD Configurator menus contain information that belongs to a certain group. In this case, you can see the current group in the toolbar at the top of the screen.

## Configurable Item Maintenance

In the System Setup section, we reviewed the product structure of the Industrial Ultrasound. If you want QAD Configurator to configure variants of this item, you must define the Industrial Ultrasound as a configurable item. If you are dealing with a multi-level product structure, you must also define every lower-level configurable item as a configurable item in QAD Configurator as well. If it recognizes an item as a configurable item, QAD Configurator references the product structure entered in the Manufacturing module whenever it has to.

The item number is copied to the QAD Configurator database when you define an item as a configurable item using Configurable Item Maintenance.

**Note** All item data, such as product structures and routings, are only maintained in the QAD Enterprise Applications database. There is no duplication of data.

### Exercise 3: Configurable Item Maintenance

The screenshot displays the 'Configurable Item Maintenance' window. At the top, there's a toolbar with 'Action', 'Print', 'Preview', 'Delete', and 'Group' buttons, along with a 'ULTRA' group indicator. The main form area is divided into several sections:

- Item Information:** 'Configurable Item' field contains '01040' with a search icon and a 'New' button. 'Description' is 'Industrial Ultrasound'. 'SO Type' is set to 'BOM'. A 'Lock Configurable Item' checkbox is present.
- Configuration Creation Rule:** 'Variant P/M' is 'M', 'Configurable P/M' is 'M'. 'Configuration Selection' is 'Select Last Matching' with an 'Auto Select' checkbox. 'Configuration Retention' is 'No Duplicates'. 'Variant Item-Site Record' is 'None'. 'Site Variable' has a search icon.
- Configuration Questionnaire:** 'Show Existing Configurations' is set to 'Second'. The 'Show All Options Of Feature' checkbox is checked.
- Cost:** 'Variant Item Cost Roll-Up' checkbox is checked. 'Cost Set' is 'Standard'.
- Pricing:** 'Calculate Configuration Price', 'Create a Price List', and 'Customer Specific List Price' checkboxes are checked. 'Allow Net Price Change' and 'Allow Manual Price List Change' checkboxes are unchecked. 'Store All Pricing Information' checkbox is checked. 'List Price Variable' is 'LIST-PRICE' and 'Net Price Variable' is 'NET-PRICE', both with search icons.
- Comments:** A section for 'Language' and 'Comment' with a search icon.

At the bottom right, there are 'Cancel', 'Save', and 'New' buttons. An 'Analyze' button is also present near the 'Analyzed On' date '4/1/2014 7:02:11 AM'.

Once an item is a configurable item, QAD Configurator is automatically launched when this item is entered on a sales quotation or sales order line.

Run Configurable Item Maintenance and click the New button to display the item browse. Select the items listed in the following table and set the attributes. Make sure that group ULTRA is selected. Accept the default value of all the other fields.

<b>Configurable Item</b>	<b>Description</b>	<b>SO Type</b>	<b>Configuration Selection / Retention</b>	<b>Variant Item Cost Roll-Up</b>	<b>Cost Set</b>
01040	Industrial Ultrasound	BOM	Select Last Matching Auto Select: Off No Duplicates	yes	Standard
50020	Industrial Housing	BOM	Select Last Matching Auto Select: Off No Duplicates	yes	Standard



# Sales Configuration

Earlier in this course, we reviewed the generic product structure and routing of the Industrial Ultrasound. Now we add the variables and features that define the characteristics of this configurable product. You can also learn how to present features as questions, as well as set up sales configuration rules to ensure data collected from the questionnaire are valid.

## Question Type Maintenance

To help the customer select the preferred configuration, provide the customer with a list of questions and potential answers. When the customer has completed this questionnaire, QAD Configurator can create a product variant.

To help organize a configuration model, questions in the QAD Configurator Questionnaire can be categorized into Question Types.

**Example** Suppose that defining a variant requires that an engineer to answer some questions. But the questions on the questionnaire are for customers. If you do not want a question on the questionnaire, you can define the question as a background question. So you can define the questions for the engineer as background questions. Furthermore, to make the purpose of the background questions clear, you would define a question type Special and attach these background questions to it. For example, questions of type Special are for the engineer.

### Exercise 4: Question Type Maintenance

Use Question Type Maintenance to add the following Question Types (Enter your own Description):

Question Type	Description	Level
Normal	Normal Questions	Foreground
Special	Special Questions	Background

## Functional Group Maintenance

Functional groups are used to categorize variants and features by their functions. For example, you can group features of a computer product into hardware, software, and accessories.

You can enter the Functional Group name in any of the QAD supported languages.

**Fig. 3.1**  
Functional Group Maintenance

You can also maintain the Functional Group name in multiple languages. For example, You have named one functional group *Accessories*. Now you want to translate the name into Chinese. You can follow these steps to set up the translation records:

- 1 Click the String Translation button.

**Fig. 3.2**  
String Translation Button

- 2 On the String Translation screen, select the target language and enter the translation.

**Fig. 3.3**  
String Translation for Functional Group Name

## Exercise 5: Functional Group Maintenance

Functional Group Maintenance X

Action Print Preview Delete Group ULTRA

Saved successfully.

Functional Group: Accessories

Description: Accessories

Run Functional Group Maintenance and add the following functional groups.

Functional Group	Description
Technical Specs	Technical Specs
Style and Size	Style and Size
Accessories	Accessories

# Variable and Variable Options Definition

Variables are general characteristics of items. Because many items can have the same characteristics, it would not be a good idea to maintain the characteristics of every item separately. So we first define the variables that we need, and then link them to the items. Depending on the data type of a variable we can define a set of possible values for it.

## Exercise 6: Variable Maintenance

The screenshot shows the 'Variable Maintenance' window with the following configuration:

- Variable:** BACKUP-TYPE (with a search icon and a 'Copy from Variable' button)
- Data Type:** Text
- Extent:** 1
- Description:** Specifies the type of battery backup

The 'Variable Details' tab is active, showing:

- Functional Group:** Accessories
- Question Type:** NORMAL
- Short Question:** Backup type (with a search icon)
- UOM:** EA
- Long Question:** Would you like alkaline or lithium batteries? (with a search icon)

At the bottom, there are radio buttons for **Question** (selected) and **Temporary**, and a checkbox for **Allow Fill-in**.

Buttons at the bottom right: Cancel, Save, New

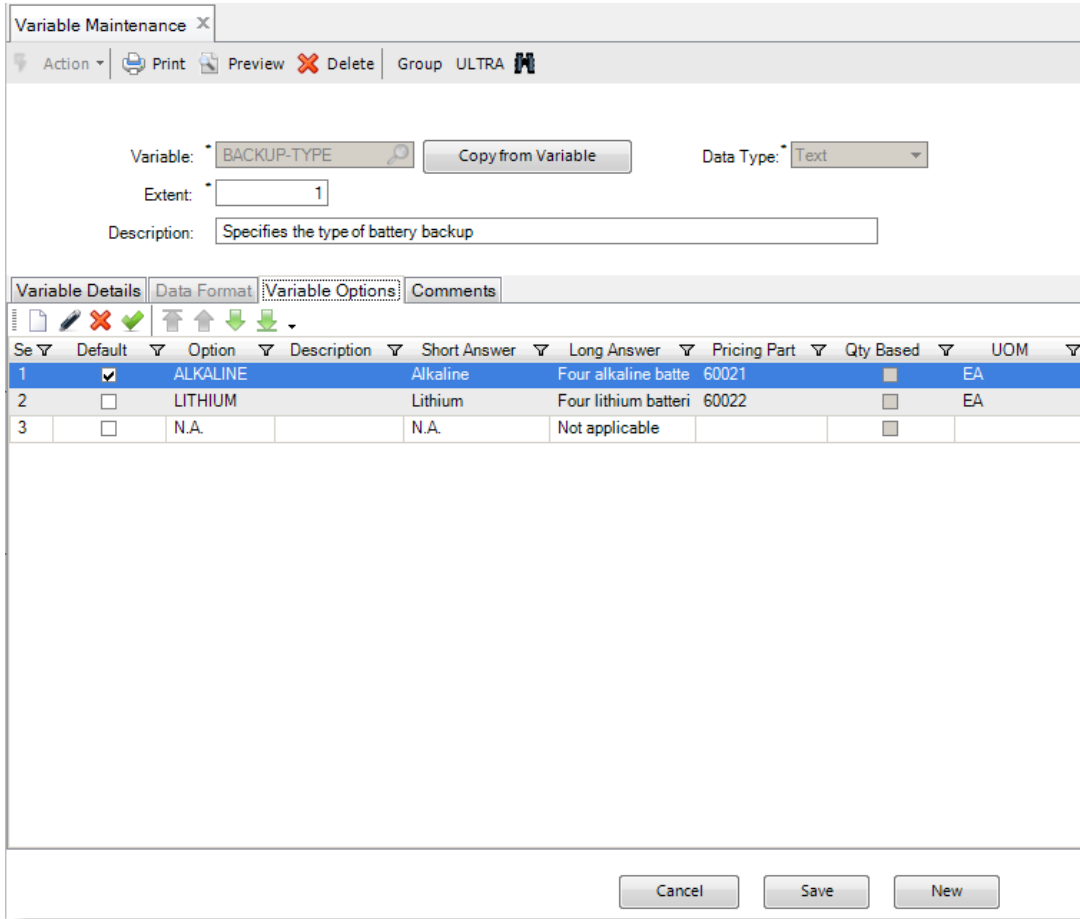

Run Variable Maintenance to define the variables and options for the configurable items.

Create the variables that are listed in the following table. Keep the default value 1 for Extent. You can add Long Question texts to the variables.

**Note** You can specify short and long questions in any of the QAD supported languages. The short question can be up to 64 characters in length. You can also maintain the question in multiple languages. Click the String Translation button next to the question field, and enter the translation on the String Translation screen. To display the short and long question of each variable in each language, you can use Variable Language Browse.

**Fig. 3.4**  
Variable Language Browse

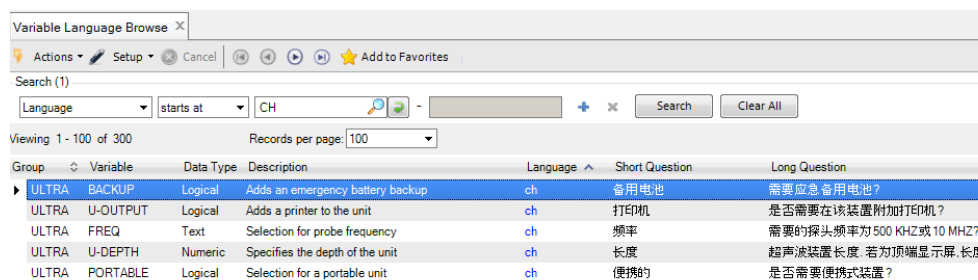

The options are specified in the Variable Options tab and the numeric parameters are specified in the Data Format tab. When you enter variable options, use the arrow buttons on the toolbar to define the order in which you want the options to appear in the questionnaire. By default, the first option in the list is the default answer for the associated question. The entry N.A. stands for not applicable. Suppose that the answer to one question makes another question superfluous.

**Note** If the variable is of type Text, Logical, Numeric List, or Date (Data Format = List), you can enter the option answers in any of the QAD supported languages. The short answer can be up to 64 characters in length. You can also maintain the answers in multiple languages. Click the String Translation button next to the answer field, and enter the translation on the String Translation screen. To display the answer for each variable option in each language, you can use Variable Option Language Browse.

Variable	Data Type	Functional Group	Question Type	Short Question	UM	Question / Temporary	Variable Options or Data Format
backup	Logical	Accessories	Normal	Backup	EA	Question	Yes No
backup-type	Text	Accessories	Normal	Backup Type	EA	Question	Alkaline NiCd LiS N.A.
country	Text	Technical Specs	Normal	Country	EA	Question	N/A [See note]
CPU	Text	Technical Specs	Normal	CPU	EA	Question	Standard High
Freq	Text	Technical	Normal	Frequency	EA	Question	500kHz. 10MHZ
Painted	Text	Technical	Normal	Painted	EA	Question	Painted Stainless
Portable	Logical	Technical Specs	Normal	Portable	EA	Question	Yes No
power	Text	Technical Specs	Normal	Power Converter	EA	Question	Smart Standard
steel-large	Numeric	Style and Size	Special	Qty - Large Steel	EA	Question	Digits: 8 Decimals: 0
steel-small	Numeric	Style and Size	Special	Qty - Small Steel	EA	Question	Digits: 8 Decimals: 0
U-area	Numeric	Style and Size	Special	Area	EA	Question	Digits: 8 Decimals: 0
U-color	Text	Style and Size	Normal	Color	EA	Question	Black White Other
U-Cover	Logical	Accessories	Normal	Keyboard Cover	EA	Question	Yes No

Variable	Data Type	Functional Group	Question Type	Short Question	UM	Question / Temporary	Variable Options or Data Format
U-height	Numeric	Style and Size	Normal	Height	EA	Question	Digits: 3 Decimals: 0 Minimum: 80 Maximum: 200 Multiplier: 40 Default: 120
U-depth	Numeric	Style and Size	Normal	Length	EA	Question	Digits: 3 Decimals: 0 Minimum: 60 Maximum: 100 Multiplier: 20 Default: 60
U-type	Text	Style and Size	Normal	Display Type	EA	Question	Top Display Front Display
U-width	Numeric	Style and Size	Normal	Width	EA	Question	Digits: 3 Decimals: 0 Minimum: 60 Maximum: 160 Multiplier: 20 Default: 60
U-output	Logical	Accessories	Normal	Printer	EA	Question	Yes No

**Note** A single variable can have more than one meaning. By defining a number of extents for such a variable, you can distinguish between its various meanings. For instance, if both the housing and the icemaker have a color, you can define a variable color and give it extent 2. Then you can use color[1] for the housing color and color[2] for the icemaker color.

**Note** The industrial ultrasound is sold in many countries. To avoid entering each country as a variable option, use the QAD Configurator browse feature. When Allow Fill-In is selected, you can also associate the variable with an existing browse. If you assign a browse code to the variable, you can select an answer from the browse, instead of manually typing in the answer.

Assign the following values to variable country.

Variable	Allow Fill-In	Browse Code
country	Yes	ad015

## Feature and Feature Options Definition

Use Feature Maintenance to create, view, edit, or delete features.

**Fig. 3.5**  
Feature Maintenance

Select a group and a configurable item using the binocular buttons on the toolbar. If you select a group that contains no configurable item in it, the system displays an error message and disables the Feature Maintenance screen.

To create a feature, click the Copy From Variable button next to the Feature field; then select a variable to associate it with the current configurable item as a feature.

To edit an existing feature, enter the feature ID in the Feature field.

You cannot delete feature when it is used in any variant planning item rule.

### Feature Details

All the feature details inherit from the selected variable details. You can change this information for the feature.

Similar to Variable Details, Feature Details also supports multiple languages. You can specify short and long questions in any of the QAD supported languages. The short question can be up to 64 characters in length. You can also translate the question from one language to another. Click the String Translation button next to the question field, and enter the translation on the String Translation screen. If the translation is already set up in Variable Details|String Translation, you can see the translation here in Feature Details|String Translation and change the translation for the feature.

You can also use Feature Language Browse to display the feature questions that you have set up for each language.

**Note** When you click Save in Feature Details|String Translation, the system:

- saves the updated record, and

- creates feature translation records for all the languages that have been set up for the variable but not the feature.

If you do not set up the translations in Feature Details, the questionnaire displays the translated records that you have set up in Variable Details. In other words, the system uses the following defaulting logic to display translated records for the questionnaire:

- If the translation is set up in Feature Details, the system takes the translation from there.
- If the translation is not set up in Feature Details but has been set up in Variable Details, the system takes the translation from there.
- Otherwise, the system has no translated records to display.

When the feature data type is text and you have selected Allow Fill-in, you can use Feature Based Pricing to calculate pricing for a feature rather than for a feature option.

**Fig. 3.6**  
Feature Value as Pricing Part

The screenshot shows the 'Feature Details' tab in the QAD Configurator. The 'Functional Group' is set to 'Technical Specs' and the 'Question Type' is 'NORMAL'. The 'Short Question' is 'Frequency' and the 'Long Question' is 'Would you like probe frequency 500 kHz or 10 MHz?'. The 'Allow Fill-in' checkbox is checked. At the bottom, the 'Pricing Part' field is empty and the 'Feature value as Pricing Part' checkbox is checked.

For feature based pricing, you can use either the Pricing Part field or the Feature Value as Pricing Part check box:

- To use the Pricing Part field, enter an existing item number from QAD EA.
- To use the Feature Value as Pricing Part check box, you select it and then the system dynamically uses the feature answer on the questionnaire as the pricing part.
  - When there is already a pricing part and you select the Feature Value as Pricing Part check box, the system prompts you to confirm your action.

**Fig. 3.7**  
Feature Value as Pricing Part or Existing Pricing Part

The screenshot shows a confirmation dialog box with the text 'Use Feature Value as Pricing Part instead of using a pricing part?' and 'OK' and 'Cancel' buttons.

- Click OK to use the answer on the questionnaire as the pricing part.
- Click Cancel to use the Pricing Part field.

## Feature Options

Feature options inherit from the options of the selected variable. To include a variable option as a feature option, select its check box on the left and then clear the check box to exclude it from the feature options.

If you set the Use Standard Options option to Yes for the current group in Master Group Maintenance, you can only use variable standard options as feature options. If you set this value to no, you can modify the variable standard options for the feature or add new options.

**Fig. 3.8**  
Feature Options List

Se	Default	Option	Description	Short Question	Long Question	Pricing Part	Qty Based	UOM
10	<input type="checkbox"/>	Red	Red	Red	The colour red	ATP01	<input type="checkbox"/>	
20	<input type="checkbox"/>	Blue	Blue	Blue	The colour blue	ATP01	<input type="checkbox"/>	
30	<input type="checkbox"/>	Green	Green	Green	The colour green	ATP01	<input type="checkbox"/>	
40	<input type="checkbox"/>	Black	Black	Black	The colour black	ATP01	<input type="checkbox"/>	

If you click the Standard Options button on the toolbar, only the variable options are available for this feature. You cannot exclude any of the variable options or add new options for this feature. Click this button again if you want to modify the standard variable options for the feature.

You can set default values for features, and then default values are on the Questionnaire. But the questions on the Questionnaire are not answered automatically. To automatically answer the questionnaire, click the Answer All button to answer all the questions using their default options.

**Note** Besides setting the default values in Feature Maintenance, you can also define default values using rules in General Rule Maintenance.

Similar to Variable Options, Feature Options also supports multiple languages. You can specify short and long answers in any of the QAD supported languages. The short answer can be up to 64 characters in length. You can also translate the answer from one language to another. Click the String Translation button, and enter the translation on the String Translation screen. If the translation is already set up in Variable Options|String Translation, you can see the translation here in Feature Options|String Translation and change the translation for the feature.

You can also use Feature Option Language Browse to display the feature option answers that you have set up for each language.

**Note** When you click Save in Feature Options|String Translation, the system:

- saves the updated record, and
- creates feature translation records for all the languages that have been set up for the variable but not the feature.

If you do not set up the translations in Feature Options, the questionnaire displays the translated records that you have set up in Variable Options. In other words, the system uses the following defaulting logic to display translated records for the questionnaire:

- When Standard Options is set to Yes:

- If the translation has been set up in Variable Options, the system takes the translation from there.
- Otherwise, the system has no translated records to display.
- When Standard Options is set to No:
  - If the translation is set up in Feature Options, the system takes the translation from there.
  - If the translation is not set up in Feature Options but has been set up in Variable Options, the system takes the translation from there.
  - Otherwise, the system has no translated records to display.

## Scenario: Dealing with a Large Number of Feature Options

In this business scenario, an item has many features and each feature has a huge number of options. If you put all those options on the questionnaire, there might be system performance issues.

In this case, you do not need to list all the feature options on the questionnaire. Instead, you can define the features as the fill-in type and let question respondents enter free-format answers or select answers from the associated browse.

**Example** A product has 20 features; for some of these features, each feature has more than 100 options. Instead of listing all these options on the questionnaire, for features which has many options, you can select Allow Fill-in and define browses for them. Take the feature *country* as an example.

- 1 In Feature Details, select Allow Fill-in and define a browse for the *country* feature.
- 2 In Feature Options, define two country names that question respondents frequently select, for example, Australia and China.

Then on the questionnaire, the respondent can select either of the frequent answers, or enter a desired country name, or select a country name from the browse.

**Fig. 3.9**  
Dealing with Many Options

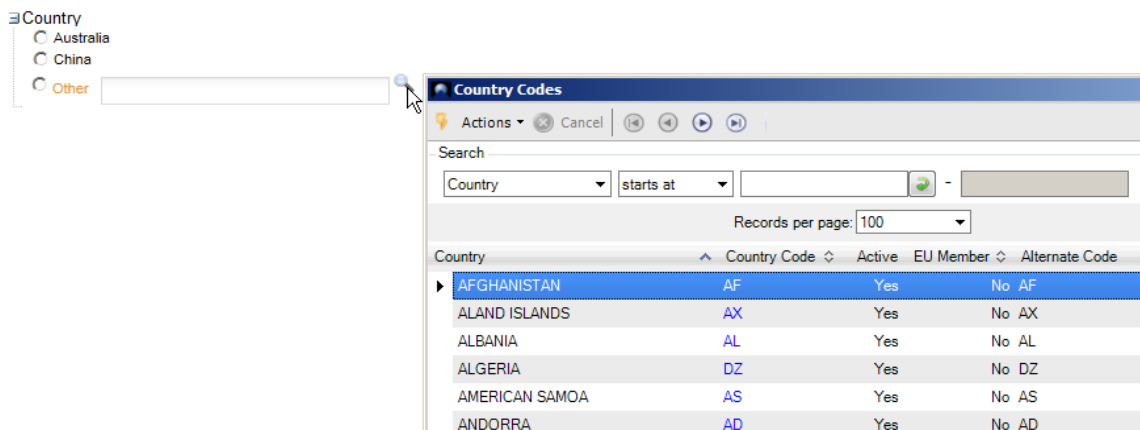

## Exercise 7: Feature Maintenance

**Note** Do not select Standard Options for housing-color. Select Standard Options for all other features.

Configurable Item	Feature
01040 Industrial Ultrasound	backup
	backup-type
	country
	CPU
	freq
	portable
	power
	U-cover
	U-output
	50020 Industrial Housing
steel-small	
painted	
U-area	
U-cover	
U-height	
U-depth	
U-type	
U-width	

## Feature Sequence Maintenance

The default feature sequence is the alphanumeric order of the feature identifiers.

**Note** Rules influence the order in which the questions are presented in the questionnaire. The system automatically assigns a sequence, based on the dependencies of questions that follow from the rules entered in the Sales Configuration Rules menu. For instance, if A depends on B, then B is before A. You, as a user, can influence the sequence, as long as you do not choose an order that is in conflict with these dependencies. If there is a conflict, the system overrules your sequence.

## Exercise 8: Feature Sequence Maintenance

Feature Sequence Maintenance x

Action Print Preview Delete Group ULTRA

Configurable Item: 01040 Description: Industrial Ultrasound

Analyzed On: 1/6/2011 12:13:49 PM Analyze

ACCESSORIES TECHNICAL SPECS

Feature	Data Type	Question Type	Description
BACKUP	Logical	NORMAL	ADDS AN EMERGENCY BATTERY BACKUP
BACKUP-TYPE	Text	NORMAL	SPECIFIES TYE TYPE OF BATTERY BACKUP
U-COVER	Logical	NORMAL	ADDS A KEYBOARD COVER
U-OUTPUT	Logical	NORMAL	ADDS A PRINTER TO THE UNIT

Run Feature Sequence Maintenance. Use the buttons on the toolbar to define the feature sequence and save your changes.

You can also change the order of functional groups by dragging and dropping the functional group tab to your required position.

## Sales Configuration Rules

Sales configuration rules determine the dependencies between the options of variables/features. They also influence the order in which the questions are presented in the questionnaire. Besides, rules determine which options become invalid as a result of answers to former questions and can even answer a question automatically if there is only one valid answer left.

Rules consist of clauses. The IF clause represents a condition. The THEN clause and the ELSE clause represent a conclusion.

You can use the following functions to define sales configuration rules:

- General Rule Maintenance
- Rule-Group Maintenance
- Item Rule Maintenance
- General Rule Table Maintenance
- Item Rule Table Maintenance

In General Rule Maintenance, you can define rules regardless of a configurable item. The rules can apply to more than one configurable item. The rules are defined independently of items and linked to items at a later stage.

In Rule-Group Maintenance, you can group general rules into a defined rule-group. A rule-group contains instance of rules concerning the same topic.

You can use Item Rule Maintenance to:

- Link general rules directly to an item, without grouping them first.
- Link a whole rule-group to an item.
- Define item-specific rules for an item.

Rule tables offer an easy way to enter a number of rules of a certain type that look very much alike. A general rule table contains rules that can be valid for more than one configurable item. An item-specific rule table contains rules that are only valid for the item for which the rule table was defined.

### General Rule Maintenance

If a rule applies to more than one item, we do not have to enter it for every item separately. Instead, we can define the rule and then link it to as many items as we want.

## Exercise 9: General Rule Maintenance

General Rule Maintenance

Action | Print | Preview | Delete | Group ULTRA

Rule ID: \* GR-000 Copy from Rule

Description:

Rule Detail Edit

Conditional

If: FREQ Value = 10MHZ

Then: CPU Value = HIGH

Else: CPU Value <> STANDARD

Switch to Free Format

Allow User Override

Update

Preview

IF:  
FREQ = 10MHZ  
THEN:  
CPU = HIGH  
ELSE:  
CPU <> STANDARD

Check Syntax

Status: Passed

Cancel Save New

Run General Rule Maintenance and create the following rule by following the instructions.

Rule ID	Rule Syntax
GR-000	if frequency = 10MHz then CPU = high else CPU = standard.

- 1 Enter GR-000 in the Rule ID field and press Enter.
- 2 In the Rule Editor pane, select Conditional rule type to display the If, Then, and Else statements.
- 3 In the If statement, select FREQ, Value, =; then click the Browse button and select 10MHz from the Variable Options box.
- 4 In the Then statement, select CPU, Value, =; then click the Browse button and select high from the Variable Options box.
- 5 In the Else statement, select CPU, Value, <>; then click the Browse button and select standard from the Variable Options box.
- 6 Click the Update button to display the rule you are composing in the Preview pane.
- 7 Click the Check Syntax button to check whether the rule syntax is correct. If the rule is valid, you can see the status Passed under the button. Otherwise, a Rule Check Configuration window pops up, displaying detailed error messages.
- 8 You have created a basic rule. Since we will not use this rule in our model, click Cancel to back-out from the rule without saving.

**Note** You can also use rules to set defaults. For numeric features, you can set minimum, maximum, and multiple quantities. For example, if the unit type is top display, we can set the maximum height of the unit to 120.

We will now add a more complex rule which we will use in our model. This rule will use attributes. Enter the following rule:

Rule ID	Rule Syntax
GR-001	if U-type = Top Display then U-height:max = 120 and U- depth:default = 100 and U-width:min = 60 else U-height:max = 200 and U-depth:default = 60 and U-width:min = 80

## Rule Group Maintenance

To categorize rules, we can create one or more empty rule groups. After we have defined a group, we can link existing general rules to the group.

When you link a general rule to a rule-group, you can decide to copy the rule to a rule-group-specific rule. In this case, the general rule remains available, but a copy of the general rule is linked to the rule-group and made specific for that particular rule-group. In this way, a modification to the general rule does not change the specific rule.

### Exercise 10: Rule Group Maintenance

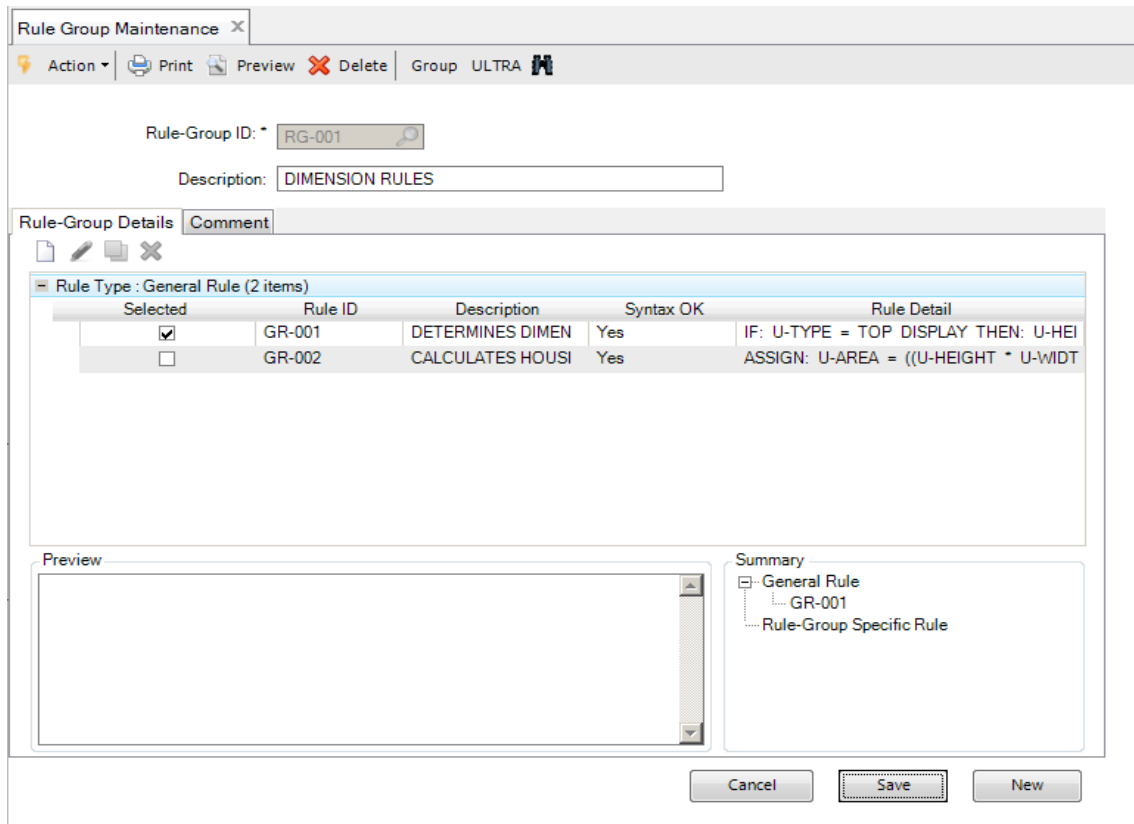

Run Rule-Group Maintenance and create a rule-group General. Select the general rule GR-001 and link it to the rule group. Save it and see the Summary pane showing the link that you created.

Rule-Group ID	Description	Rule ID of General Rule Linked
RG-001	Dimension rules	GR-001

In the Rule Group Details tab, select the available rules. A Copy symbol in the toolbar of the tab allows you to create a rule-group specific copy of any displayed rule.

## Item Rule Maintenance

In Item Rule Maintenance, you can link general rules or rule groups to configurable items. You can also create new rules that apply for a specific configurable item. New item-specific rules can be entered directly or copied from a general rule.

### Exercise 11: Item Rule Maintenance: Link Rule-Group

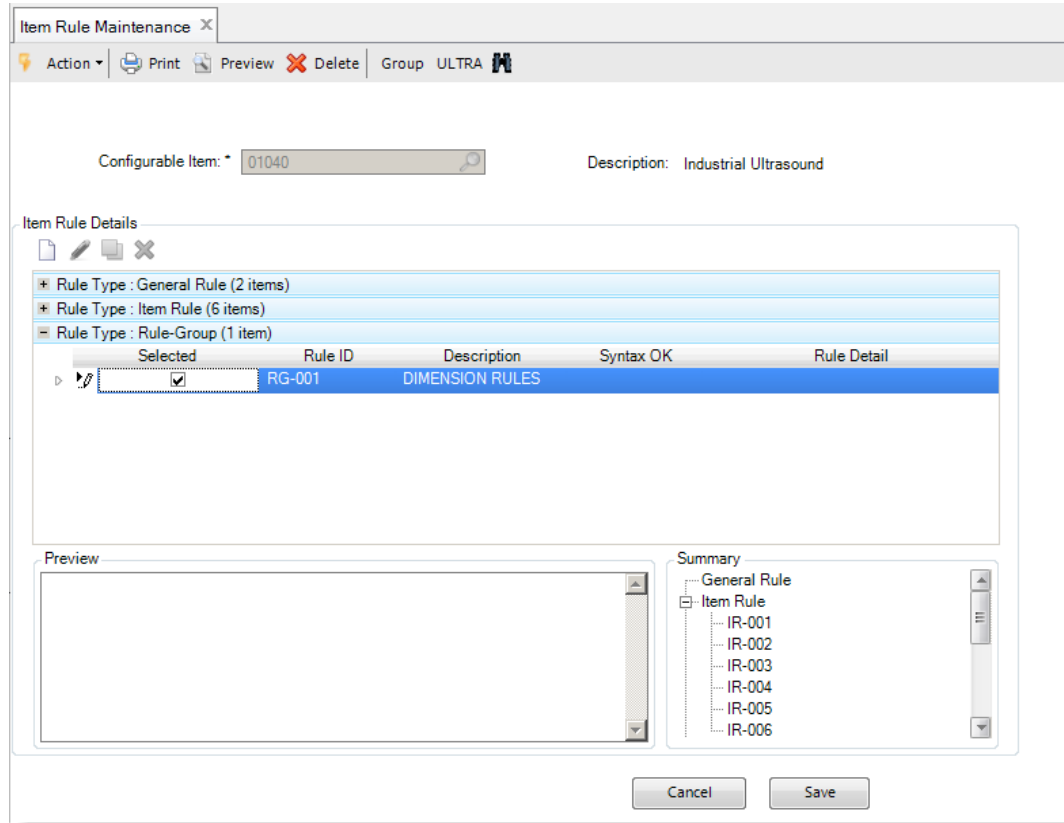

Use Item Rule Maintenance to link the rule group RG-001 to the Industrial Ultrasound by selecting it. Save it and see the Summary pane showing the link that you created.

Rule-Group ID	Item to link this rule to
RG-001	01040 (Industrial Ultrasound)

So far we have discussed how we can define general rules, how we can link general rules to items through rule groups and how we can link them to items directly. And we saw how we can define an item-specific rule by converting a general rule.

Item-specific rules can be entered directly — that is, without first entering a general rule and then modifying it. An item-specific rule that is entered directly only exists for that particular item and cannot be used elsewhere.

### Exercise 12: Item Rule Maintenance: Create Item Rule

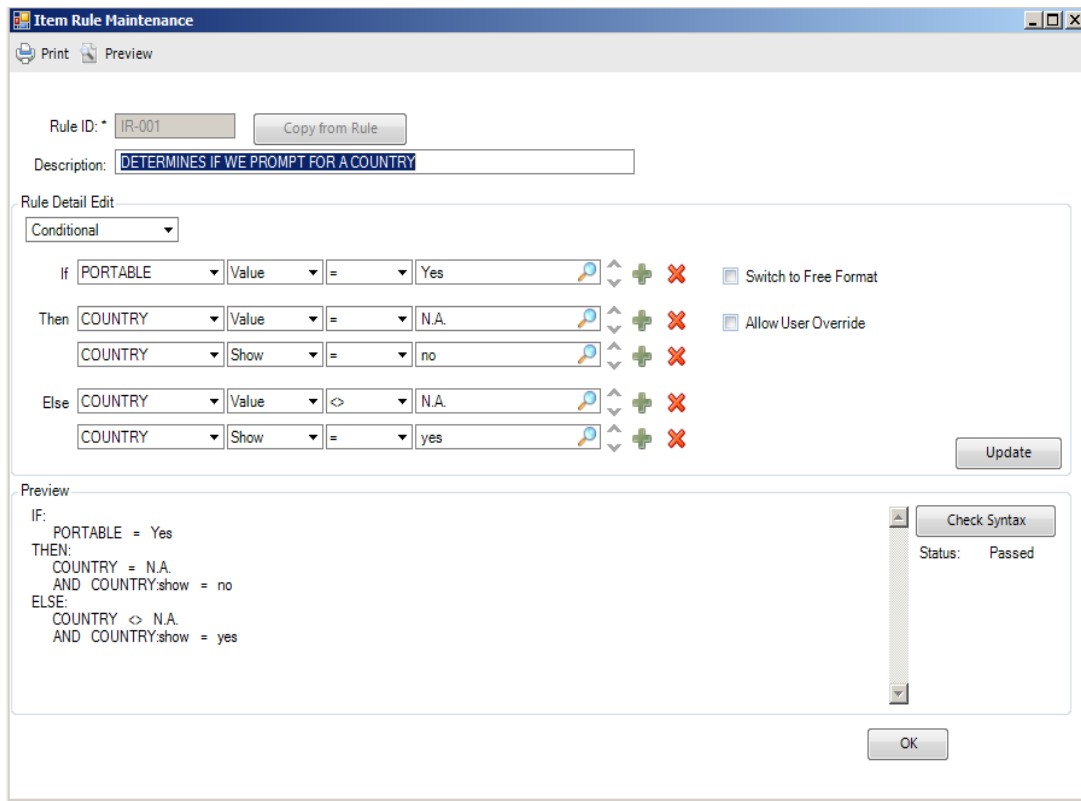

We now want to add the rules for the various levels of configurable items. Run Item Rule Maintenance to add the item-specific rules as follows. Some of the rules for item 50020 require the use of attributes.

Item	Rule ID	Item-Specific Rule
01040	IR-001	if portable = Yes then country = N.A. and country:show = No else country <> N.A. and country:show = Yes
01040	IR-002	If backup = No then backup-type = N.A. else backup-type <> N.A.
01040	IR-003	ASSIGN: model=1
50020	IR-501	If painted = Stainless then U-color = N.A.and U-Color:show = No else U-color <> N.A. and U-color:show = Yes

## Remarks and Exercises on Rule Modes

A rule generally consists of one preposition (IF), one conclusion (THEN), and possibly one alternative (ELSE). These clauses can contain one or more lines and can have different formats: basic, advanced, and free format.

A basic clause looks like the following:

```
Variable = option.
```

The rules you entered previously are of this type (all clauses are now in normal mode), for instance:

```
If portable = Yes then country = "N/A" else country <> "N/A"
```

An advanced clause is used to enter slightly more complicated expressions.

```
Variable = expression.
```

**Example** The THEN clause here is in advanced mode.

```
If housing-type = Single Door Front then housing-length = 0.5 * housing-width + 0.1 * housing-height.
```

A free format clause can be used to create complex rules. A clause of this type contains a Boolean expression which is true or false. This rule mode is only available for if-clauses. A rule of the free format type cannot be converted back to another rule format. So when you select the free format rule mode, the system always prompts you to confirm your choice.

Here is an example:

```
If 0.1 * (U-width * U-depth) > 0.5 * (U-width + U-height) then backup = yes.
```

Practice with the different rule modes that are available.

## Exercise 13: General Rule Maintenance: Advanced Mode

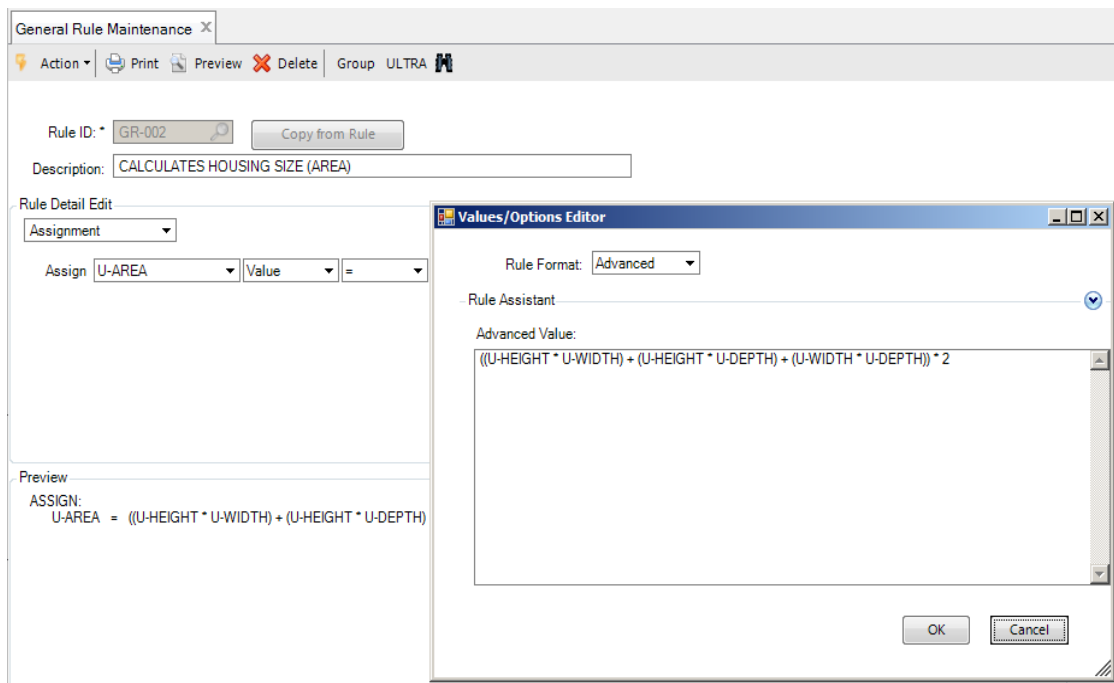

When only a Then clause is defined, an assignment rule is created. An assignment rule is executed each time a question is answered in the questionnaire.

Now run General Rule Maintenance and enter the rule GR-002. In the Rule Detail Edit frame, select Assignment from the list box. Select a feature from the Assign list box, click Values/Options, and select the Advanced rule format. Now you have an advanced window in which you can type the remaining part of your then-statement. You can also use the Rule Assistant to enter it.

Rule ID	Item-Specific Rule
GR-002	$U\text{-area} = ((U\text{-height} * U\text{-width}) + (U\text{-height} * U\text{-depth}) + (U\text{-width} * U\text{-depth})) * 2$

Notice that this clause is now saved as an assignment rule because it only contains a THEN-clause. Now run Rule Group Maintenance and link Rule GR-002 to Rule Group RG-001.

### Exercise 14: Item Rule Maintenance: Free Format Mode

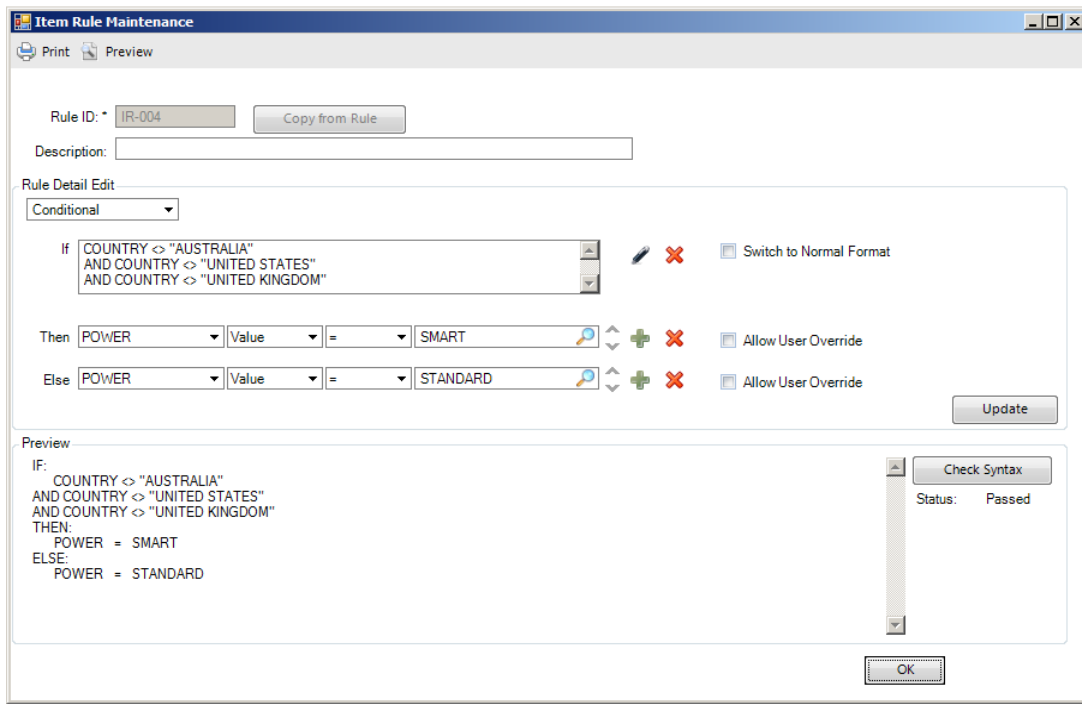

Run Item Rule Maintenance. Enter the rule by selecting Switch to Free Format in the If clause:

Item	Rule ID	If Clause	Then Clause	ELSE Clause
01040	IR-004	country <> "AUSTRALIA" AND country <> "UNITED STATES" AND country <> "UNITED KINGDOM"	power = Smart	power = Standard

Update the rule and verify your rule using the Check Syntax button.

General Rule ID	Rule Group to Link this Rule to
GR-002	RG-001

## Rule Tables

With a rule table you can define rules in a different, sometimes easier way. For example, the rules are simple, but there are many different combinations of the options. By selecting some variables and filling in a rule table, you can let QAD Configurator automatically create a number of IF...THEN... rules for you.

**Note** In a rule table, rules do not contain ELSE clauses.

Rule tables can be either general or item-specific.

- You can define a general rule table and link it to one or more items.
- You can also define an item-specific rule table. It can only be maintained for the particular item for which it was created.

QAD Configurator guides you through defining a rule table, according to the following steps:

- 1 Select Condition
- 2 Set Value for Condition
- 3 Select Conclusion
- 4 Set Value for Conclusion

When defining an item-specific rule table you use features instead of variables.

The maximum number of variables in a single rule table is 20. You can have as many condition variables (IF) and as many result variables (THEN) as you want, as long as the total does not exceed 20. A variable has an ID, an extent, and an attribute. Each row in the table represents a rule.

**Example** The rule:

```
if U-height <= 120 and U-width >80 and U-depth <= 80
then steel-small = 2 and steel-large = 4
```

is shown as follows:

IF U-height: Value	IF U-width: Value	IF U-length: Value	THEN steel-small: Value	THEN steel-large: Value
:120	[:80]	:80	2	4

Special syntax-rules have been devised for the contents of the cells of the rule tables.

The following entries are possible:

Entry	Meaning
value1	value1
value1 value2 value3	value1 or value2 or value3
value1:value2	>= value1 and <= value2
:value1	<= value1
value1:	>= value1
[value1]	not value1
[value1 value2 value3]	not value1 and not value2 and not value3
[value1:value2]	< value1 or > value2

Entry	Meaning
[value1]	> value1
[value1:]	< value1
[value1]:value2	> value1 and <= value2
[value1]:[value2]	> value1 and < value2
value1:[value2]	>= value1 and < value2
:[value1]	< value1
[value1]:	> value1
[[value1]:value2]	<= value1 or > value2
[[value1]:[value2]]	<= value1 or >= value2
[value1:[value2]]	< value1 or >= value2
:[value1]]	>= value1
[[value1]:]	<= value1

Entering a list of values and/or using exclusions for a result variable is only possible if all of the following conditions are met:

- The result variable is of the type Text, Numeric List, or Date
- The attribute of the result variable is value.

Otherwise, lists and exclusions are meaningless and therefore not allowed.

You can move through the cells of a table by using Tab, Shift + Tab, Page Up, Page Down, Up Arrow and Down Arrow on the keyboard.

**Note** For rule tables, there is no equivalent to the concept of rule groups.

Rules in a table can only be built from the variables in the table. However, not every variable is used in a rule. So a column belonging to a variable can have empty cells for some rules in the table.

## General Rule Table Maintenance

Using General Rule Table Maintenance you can define general rule tables. They can be linked to one or more items later on.

### Exercise 15: General Rule Table Maintenance — Manual entry

The screenshot shows the 'General Rule Table Maintenance' window. At the top, there is a toolbar with 'Action', 'Print', 'Preview', 'Delete', and 'Group' buttons. The 'Rule Table' field contains 'GRT-5001' and the 'Description' field contains 'USE HEIGHT, WIDTH, DEPTH TO CALCULATE NUMBER OF SHEETS'. Below this is a table with columns for 'IF' conditions and 'THEN' results. The table has 9 rows, with row 1 highlighted in blue. The 'IF' conditions are based on 'U-HEIGHT:Value', 'U-WIDTH:Value', and 'U-DEPTH:Value'. The 'THEN' results are based on 'STEEL-SMALL:Value' and 'STEEL-LARGE:Value'. At the bottom, there are buttons for 'Accelerator', 'Modify', 'Cancel', 'Save', and 'New', along with 'Interpolation: Disabled' and 'Accelerated: Disabled' labels.

	IF U-HEIGHT:Value	IF U-WIDTH:Value	IF U-DEPTH:Value	THEN STEEL-SMALL:Value	THEN STEEL-LARGE:Value
1	:120	:60	:60	4	0
2	:120	:60	[:60]	2	1
3	:120	[:60]	:60	2	1
4	:120	[:60]	[:60]	1	2
5	[:120]	:60	:60	1	2
6	[:120]	:60	[:60]	1	3
7	[:120]	[:60]	:60	1	3
8	[:120]	[:60]	[:60]	0	4
9					

Run General Rule Table Maintenance. Enter the table ID and a description. Now go to Step 1 and select the variables as follows (you can select several condition variables at the same time).

Rule Table	Condition Variables
GRT-5001	U-height (value) U-length (value) U-width (value)

Press Next twice to skip Step 2 and go to Step 3. Select the result variables as follows (again, you can select several condition variables at the same time).

Rule Table	Result Variables
GRT-5001	steel-small (value) steel-large (value)

Press Finish. The system informs you that no records have been created automatically. Then go to the Rule Table tab.

Now enter these rules in the table:

Row	IF U-height: Value	IF U-width: Value	IF U-depth: Value	THEN steel-small: Value	THEN steel-large: Value
1	[:120]	[:60]	[:60]	0	4
2	[:120]	[:60]	:60	1	3
3	[:120]	:60	[:60]	1	3
4	[:120]	:60	:60	1	2
5	:120	[:60]	[:60]	1	2
6	:120	[:60]	:60	1	1
7	:120	:60	[:60]	2	1
8	:120	:60	:60	4	0

(Row 1 says: If housing-U > 120 and U-width > 60 and U-depth > 60, then steel-small = 0 and steel-large = 4.)

Have a look at the formula by choosing the Preview button on the toolbar. It shows the contents of the selected row, in the form of a complex rule.

Some special keys for navigating through the Table and for doing some simple actions are listed in the following table.

Keyboard Keys	Meaning
Arrow key up	Go one cell up
Arrow key down	Go one cell down
Page Up	Go 12 cells up (if available)
Page Down	Go 12 cells down (if available)
Home	Go to the first row in the rule table
End	Go to the last row in the rule table
Tab	Go one column to the right
Shift+Tab	Go one column to the left
Ctrl+G	Go to the row with the given row number
Ctrl+F	Start the Search and Replace function

## Exercise 16: General Rule Table Maintenance: Auto-Generation

General Rule Table Maintenance

Action Print Preview Delete Group ULTRA

Rule Table: \* GRT-5001

Description: USE HEIGHT, WIDTH, DEPTH TO CALCULATE NUMBER OF SHEETS

Generation Rule Table

Step 1 - Select Condition Step 2 - Set Value for Condition Step 3 - Select Conclusion Step 4 - Set Value for Conclusion

Available Variables:

- BACKUP
- BACKUP-TYPE
- COUNTRY
- CPU
- FREQ
- ITEM-DESC
- LIST-PRICE
- MODEL
- NET-PRICE
- PAINTED
- PORTABLE
- POWER
- STEEL-LARGE
- STEEL-SMALL

Attributes:

Include

Exclude

Selected Variables:

- U-HEIGHT : Value
- U-WIDTH : Value
- U-DEPTH : Value

Action: Add Rows

Interpolation

Cancel Finish Next

General Rule Table Maintenance also enables you to add rows (rules) to a table or to delete rows from a table in an easy way. It is especially useful when the rules you want to add or delete are reflecting most combinations of input (If) and output (Then) criteria.

Enter the following rules in the table GRT-002:

Row	IF country: Value	IF freq: Value	IF CPU: Value	THEN power: Value
1	AUSTRALIA	500kHz	Standard	Standard
2	AUSTRALIA	10MHz	High	Smart
3	UNITED KINGDOM	500kHz	Standard	Standard
4	UNITED KINGDOM	10MHz	High	Smart
5	UNITED STATES	500kHz	Standard	Standard
6	UNITED STATES	10MHz	High	Smart

Run General Rule Table Maintenance. Enter the table ID (GRT-002) and a description.

1 Select the variables as follows. You can select several condition variables at the same time.

Rule Table	Condition Variables
GRT-002	country (value) freq (value) CPU (value)

2 Select the following values:

- country is AUSTRALIA, UNITED KINGDOM, or UNITED STATES
- freq is either 500kHz or 10MHz
- CPU is either Standard or High Performance

**Note** The options for the variable country are provided through a browse. Click the Add Value button to manually add the required countries.

3 Select the result variables as follows:

Rule Table	Result Variables
GRT-002	power (value)

4 Select power as Standard.

**Note** Because power is a result variable and because you are adding rows, you can only enter one option for power.

The system generates all possible combinations of the options you entered and adds a rule to the table for every combination it created. It also reports the number of rows it has added to the table. Click OK to close this message and move to the Rule Table tab. The table contains 12 rows.

Now you can manually edit the rules. Delete the rules that have been created that you do not need. Manually change the cells in which power does not have the correct value.

**Note** When you delete a row, the system updates the numbers of the remaining ones. Therefore, it is better to delete the rows in descending order. To delete a rule (row), position the cursor in the cell containing the row number, click the mouse to select the row, then press the Delete button on the toolbar.

Any rules added automatically to a rule table can be modified manually at any time.

Experiment a little with the different formats of the entries. See the list of possible formats that was given earlier. To enter something in a cell you can type it directly in the cell, or select it from the option list you can switch on using the Options icon on the toolbar. You can enter the straight brackets by hand or click the Exclusion check box in the option list. You can also create lists by highlighting more than one option in the option list. For other special symbols, type them manually. We do not link this general rule table to any item.

## Item Rule Table Maintenance

You can create item-specific rule tables, which can only be maintained for the item for which they were created. An item-specific rule table is either a modified general rule table or a new rule table that is entered only for a particular item.

The Item Rule Table Maintenance window looks like the Item Rule Maintenance window. The available general rule tables are shown in a list and you can link them to the current item by selecting them and clicking the check box. To copy a general rule table, select it and click Copy on the toolbar. You can see a copy shown in the Specific section in the Summary pane.

You can also create an item-specific rule table directly. To do so, you enter the new table in the same way as when you used General Rule Table Maintenance.

## Exercise 17: Item Rule Table Maintenance

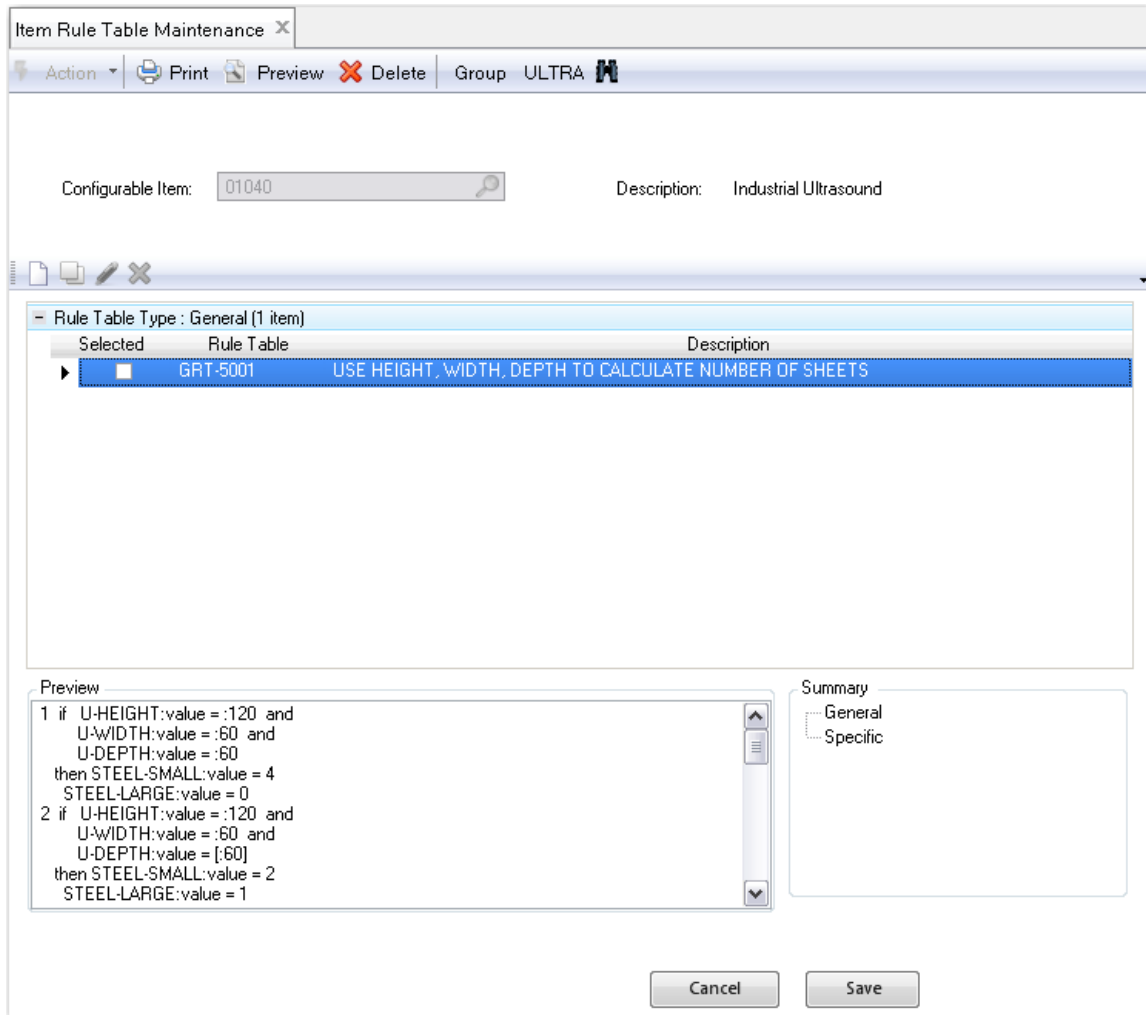

Run Item Rule Table Maintenance and link the general rule table you created (GRT-5001) to item 50020:

Rule Table	Item to Link the Table to
GRT-5001	50020

## Configuration Key Maintenance

Use Configuration Key Maintenance to specify which features uniquely identify a configuration. The system automatically matches every new configuration with the existing ones based on the configuration key. If it finds existing configurations that match the one you defined, the system suggests you use the existing one instead of creating one. In this way, the item database does not grow unnecessarily.

QAD Configurator creates a configuration for every variant of a configurable item. So you have to define configuration keys for each configurable item in the generic multi-level product structure.

Now suppose that after some time you want to change the configuration key defined earlier. The system automatically updates the configuration key of existing configurations when a record is saved in Configuration Key Maintenance.

### Exercise 18: Configuration Key Maintenance

Configuration Key Maintenance

Action Print Preview Delete Group ULTRA

Configurable Item \* 01040 Description Industrial Ultrasound

Features	Configuration Key
ITEM-DESC	BACKUP
LIST-PRICE	BACKUP-TYPE
MODEL	COUNTRY
NET-PRICE	CPU
	FREQ
	PORTABLE
	POWER
	U-COVER
	U-OUTPUT

Include  
Include All  
Exclude  
Exclude All

Run Configuration Key Maintenance. Select the Industrial Ultrasound (item 01040) and create a configuration key consisting of the features that are shown in the following table. Repeat this procedure for the lower level configurable item 50020

Item	Configuration Key
01040	backup backup-type country CPU freq portable power U-cover U-output
50020	painted U-type

To specify configuration keys for a configurable item:

- 1 Specify a configurable item in the Configurable Item field.
- 2 To set a feature as a configuration key, select it in the Features list box and click Include to move it to the Configuration Keys list box. Click Include All to set all available features as configuration keys.  
To remove a configuration key, select it in the Configuration list box and click Exclude to move it to the Feature list box. Click Exclude All to remove all configuration keys.
- 3 Click Save.



# Product Configuration

We start with the product configuration rules. Then we analyze the model to ensure that there are no inconsistencies in the rules we have entered.

## Product Configuration Rules

This set of rules lets you define how the variant item, variant product structure, and variant routing are generated.

### Variant Item Number Rule Maintenance

Use Variant Item Number Rule Maintenance to define how QAD Configurator assigns item numbers to new variant items. You can define rules for each configurable item from which you intend to create variant items. It is compulsory to enter variant item number definitions for all configurable items in your model. If one definition is missing, QAD Configurator cannot store the configuration correctly. The system cannot generate the variant until you have entered all necessary definitions.

### Exercise 19: Variant Item Number Rule Maintenance

Variant Item Number Rule Maint

Action Print Preview Delete Group ULTRA

Configurable Item: 01040 Description: Industrial Ultrasound

Function:  Item  Sales Quote  Sales Order Copy Rules

Rule Detail

Variant Item Number Format: 01040-999

Element: Fixed Add

Element	Input	Multiplier	From	To	Length				
Current Configurabl	01040		1	5	5				
Character	-				1				
Numeric Sequence	1	1			3				

Cancel Save

Run Variant Item Number Rule Maintenance and define the following variant item number definition for the configurable items 01040 and 50020. Select Function equals Item.

Element	Input	Multiplier	From	To	Length
Current Configurable Item			1	5	5
Character	-				
Numeric Sequence	1	1			3

### Variant Item Data Rule Maintenance

Use Variant Item Data Rule Maintenance to assign values to fields in the QAD Enterprise Applications Item Master table (pt\_mstr) for the new variant items.

### Exercise 20: Variant Item Data Rules Maintenance

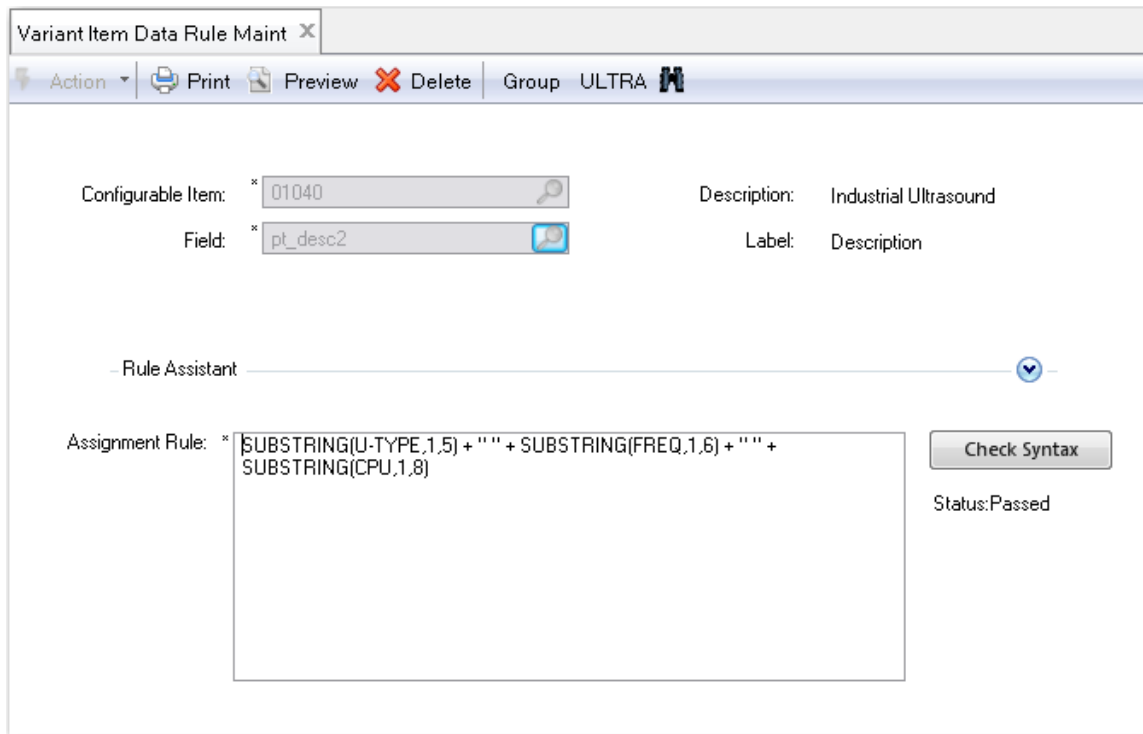

Run Variant Item Data Rule Maintenance and enter the following information. The system concatenates the first two characters of the variables and the variable volume, and stores the results in the pt\_desc2 field of configurable item 01040.

Configurable Item	Field	Assignment Rule
01040	pt_desc2	SUBSTRING(U-type, 1, 5) + "" + SUBSTRING(freq, 1, 6) + "" + SUBSTRING(CPU, 1, 8)

### General Product Structure Rule Maintenance

Use General Product Structure Rule Maintenance to define general selection rules for selecting components into variant product structures that are not specific to configurable items. In this way, some components defined in the rule can always be selected.

## Exercise 21: General Product Structure Rule Maintenance

General Prod Struct Rule Maint

Action Print Preview Delete Group ULTRA

Component: \* 50001 Description: Probe Unit - 10 Mhz

Rule Assistant

Selection Rule: freq="10MHz"

Check Syntax

Status:Passed

- Run General Product Structure Rule Maintenance and enter the following selection rules. Component 50001 is selected whenever the frequency is 10MHz.
- Component 50002 is selected whenever the frequency is 500kHz.
- Component 60050 is selected whenever a standard CPU is required.
- Component 60052 is selected whenever a high performance CPU is required.

Component	Description	Selection Rule
50001	Probe Unit - 10MHz	Freq = "10MHz"
50002	Probe Unit - 500kHz	Freq = "500kHz"
60050	Base Unit / CPU	CPU = "Standard"
60052	High Performance CPU	CPU = "High"

**Note** You can use Rule Assistant to enter the selection rule.

## Variant Product Structure Rule Maintenance

Use Variant Product Structure Rule Maintenance to define selection rules for component items of a configurable item. If no selection rule is defined for a component in the generic product structure, the component is always selected in the variant product structure. The exception is that the parent item of the component is not selected due to selection rules.

## Exercise 22: Variant Product Structure Rule Maintenance

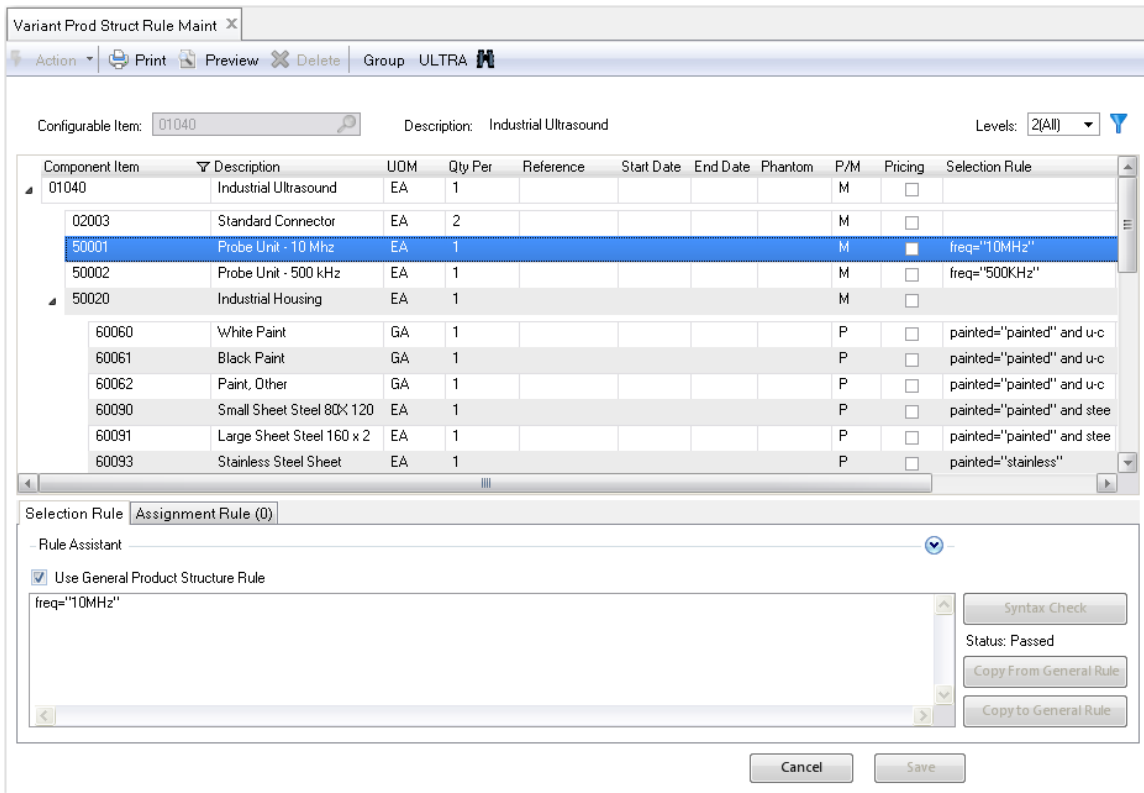

Run Variant Product Structure Rule Maintenance and select configurable item 01040. Click a certain component and you can see the Selection Rule section in the lower part of the screen. In the Selection Rule section, you can enter the rule that specifies when that component is selected.

In the Assignment Rule tab in the lower part of the screen, you can assign values to all fields in QAD EA Product Structure Master table (ps\_mstr). You can view all field names by using the Insert/Update button and then clicking the browse.

If you do not specify a selection rule for a component, the component is always selected. If you do not specify any assignment rules, the system copies the values from the generic product structure to the variant product structure.

Now add the first selection rule step by step.

Configurable	Component	Description	Selection Rule
01040	60080	Power cord, UK	Portable = No and country = "UNITED KINGDOM"

Enter this rule by following these steps:

- 1 Run Variant Product Structure Rule Maintenance.
- 2 Enter the parent configurable item 01040, and select Level 2(All).
- 3 Click component item 60080.
- 4 Position the cursor in the Selection Rule field in the Selection Rule tab.

- 5 Now type: portable = No and country= “UNITED KINGDOM” or use the Rule Assistant to enter this expression.
- 6 Click the Check Syntax button.
- 7 If the rule is not correctly entered, solve the problems.
- 8 Click the Save button.

Now add the following selection rules. Try to understand why they are specified this way. For example, item 50020 is always selected, since it does not have a selection rule. Similarly, components 02003, 60001, 60003, 60020 and 90093 are always selected.

**Note** Leave the Use General Product Structure Rule check box unchecked.

Do not enter anything for the other components. They are always selected.

Configurable Item	Component	Description	Selection Rule
01040	60005	Battery	portable = Yes
	60008	Printer	U-output = Yes
	60015	Keyboard Cover	U-cover = Yes
	60080	Power Cord - UK	Portable = No and country = “UNITED KINGDOM”
	60081	Power Cord - Australia	Portable = No and country = “AUSTRALIA”
	60082	Power Cord - USA	Portable = No and country = “UNITED STATES”
	60083	Power Cord - Universal	Portable = No and country <> “UNITED KINGDOM” AND country <> “AUSTRALIA” AND country <> “UNITED STATES”
	60021	Battery Backup, Alkaline	backup-type = “Alkaline”
	60023	Battery Backup, NiCd	backup-type = “NiCd”
	60022	Battery Backup, Lithium	backup-type = “Lithium”
50020	60088	Power Converter - Standard	Power = “Standard”
	60060	White Paint	Painted = “painted” and u-color = “white”
	60061	Black Paint	Painted = “painted” and u-color= “black”
	60062	Paint, Other	Painted = “painted” and u-color <> “white” and u-color <> “black”
	60090	Small Sheet Steel, 80x120 cm	Painted = “painted” and steel-small > 0
	60091	Large Sheet Steel, 160x200 cm	Painted = “painted” and steel-large > 0
	60093	Stainless Steel Sheet, 80x120 cm	Painted = “stainless”
	60093	Stainless Steel Sheet, 160*200 cm	Painted = “stainless”

Now go back to configurable item 01040 and make sure that the following selection rules are added.

**Note** These components use General Product Structure Rules.

Configurable Item	Component	Description	Selection Rule
01040	50001	Probe Unit - 10MHz	freq = "10MHz"
	50002	Probe Unit - 500kHz	freq = "500kHz"
	60050	Base Unit / CPU	CPU = "Standard"
	50052	High Performance CPU	CPU = "High"

Now enter the following assignment rule for component item 60089:

Configurable Item	Component	Field	Assignment Rule
01040	60089	ps_rmks	"This ultrasound unit requires a small power converter. Include instructions."

Now go back to configurable item 50020 and enter the following assignment rules:

Configurable Item	Component	Field	Assignment Rule
50020	60060	ps_qty_per	ps_qty_per * U-area / 100000
	600601	ps_qty_per	ps_qty_per * U-area / 100000
	60062	ps_qty_per	ps_qty_per * U-area / 100000
	60062	Ps_rmks	"Customer has specified non-standard color - check order for details"
	60090	ps_qty_per	steel-small
	60091	ps_qty_per	steel-large

## Variant Routing Rule Maintenance

Use Variant Routing Rule Maintenance to define selection rules for operations in the generic routing. If no selection rule has been defined in the generic routing, the operation is always selected in the variant product structure.

### Exercise 23: Variant Routing Rule Maintenance

Operation	Description	Machine	Start Effective	Selection Rule	Assignment Rule
10	ASSEMBLE COMPONENTS	1001			Yes
20	TEST FINISHED UNIT	1001			
30	PACK FOR SHIPPING	1001			

Run Variant Routing Rule Maintenance and select configurable item 01040.

The system now lists all the operations in the item's generic routing. Again, this screen has two parts: Selection Rule and Assignment Rule.

- In Selection Rule, you define when to select an operation.
- In Assignment Rule, you can assign values to all fields in QAD EA Routing Operation Detail table (ro\_det). You can see all the available fields by using the Insert/Update button and then clicking the browse.

If you do not enter a Selection Rule, the operation is always selected. If you leave the Assignment Rule empty, the system copies the values from the generic routing to the variant routing.

Now add the Selection and Assignment Rules for the configurable items 01040 and 50020 as listed in the table.

The first Assignment Rule: if backup is yes, then runtime for operation 10 is the current runtime of operation 10 plus 0.15 hour; otherwise, use the current runtime.

The second Assignment Rule: if unit depth, width and height exceed 80, 80 and 120 respectively, runtime for operation 10 is 1.5 hour; otherwise, it is 1 hour.

The third assignment rule updates the operation description of operation 20 with the color of the paint to use.

Configurable Item	Operation	Selection Rule	Field	Assignment Rule
01040	10		ro_run	if backup = yes then (ro_run + 0.15) else ro_run
50020	10		ro_run	if u-height>120 and u-width>80 and u-depth>80 then 1.5 else 1
	20	painted <> "stainless"	ro_desc	"Paint" + u-color

Notice that the operations for 01040 are always selected. The same is true for operation 10, 30 and 40 of item 50020. Operation 20 for item 50020 is only selected if bee stainless steel has not been selected.

## Exercise 24: Variant Routing Maintenance

Features can also be used to populate comments in the variant routing. Those comments can provide additional instructions and information to the personnel operating the assembly line.

Use Routing Maintenance (14.13.1) in the Manufacturing module to enter the following comment for Routing Code 50020 and Operation 10. Enter Yes in the Comment field of this operation and then add the following comments:

- The depth of the housing is: [U-depth]
- The width of the housing is: [U-width]
- The height of the housing is: [U-height]

When the variant routing is created, QAD Configurator replaces the placeholders with the actual value of the feature.

## Element Roll-Up Rule Maintenance

You can use element roll-up to roll up non-cost related data elements in a variant product structure or routing.

The roll-up can contain:

- Item data (pt\_mstr)
- Operation data (opm\_mstr)
- Product structure data (ps\_mstr)
- Routing data (ro\_det)

Some roll-up examples are: runtimes, selling prices, weights, numbers, and sizes.

Roll-up rules can be executed one level up or all levels up and can consist of:

- Simple expressions containing a single element; for example: roll up pt\_mfg\_lead, which rolls up the production lead time of all components
- Complex expressions containing calculations; for example: roll up (component: pt\_abc\_qty / master: pt\_dec01) \* ps\_qty\_per

When rolling up data through all levels of the variant product structure, QAD Configurator does not store intermediate results in lower level configurable items. Only the total is stored with the variant item.

The next diagram shows examples of a one level roll-up (to the nearest parent item) and an all-level roll-up (to the uppermost parent item) for a variant product structure. A variant routing is handled similarly.

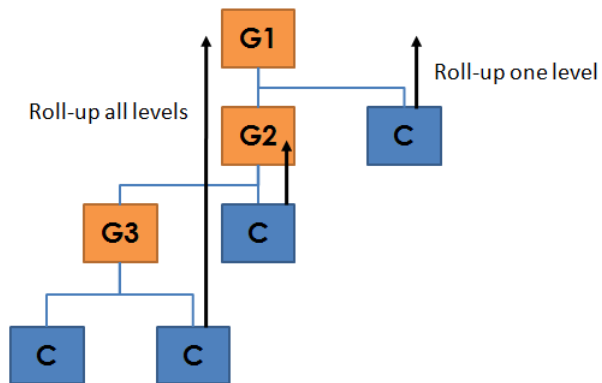

## Exercise 25: Element Roll-up Rule Maintenance

Run Element Roll-Up Rule Maintenance and enter the rule as listed in the table.

Use Element Rule Roll-Up Maintenance to create the following element roll-up rule for item 01040 and 50020:

Field	Entry
Master Element	pt_net_wt
Take Product Structure Qty's into Account	Yes
Rule Type	Basic
Roll-Up Type	Product Structure
Roll-Up Data	Item
Roll-Up Element	pt_net_wt

## Configuration Analyzer/Cross Validation Analyzer

Before running the questionnaire to start the configuration process, check the sales configuration rules that we have entered to identify any inconsistencies. Use Configuration Analyzer. It includes all features and rules when building up the question sequence in the questionnaire.

The Cross Validation Analyzer can also detect any discrepancies between the product configuration rules and sales configuration rules.

### Exercise 26: Configuration Analyzer and Cross Validation Analyzer

The screenshot shows the Configuration Analyzer application window. The main window has a menu bar with 'Action', 'Print', 'Preview', 'Delete', and 'Group'. Below the menu bar, there are input fields for 'Configurable Item' (01040) and 'To' (01040). A smaller 'Analyze Report' window is overlaid on top, showing the following text:

```

19:21:15 Start Analysing...

-----
Analyse. Item: 50020
-----

```

Low Level Code	Feature	Relations found	Seq.
0	PAINTED	[1] U-COLOR	6
0	U-TYPE	[1] U-DEPTH	7
0	U-TYPE	[1] U-HEIGHT	8
0	U-TYPE	[1] U-WIDTH	10
0	U-COVER	[0]	999999
1	U-WIDTH	[1] STEEL-LARGE	3
1	U-DEPTH	[1] STEEL-LARGE	3
1	U-HEIGHT	[1] STEEL-LARGE	3
1	U-WIDTH	[1] STEEL-SMALL	4
1	U-HEIGHT	[1] STEEL-SMALL	4
1	U-DEPTH	[1] STEEL-SMALL	4
1	U-HEIGHT	[1] U-AREA	5
1	U-DEPTH	[1] U-AREA	5
1	U-WIDTH	[1] U-AREA	5
1	U-COLOR	[0]	999999
2	U-AREA	[0]	999999
2	STEEL-SMALL	[0]	999999
2	STEEL-LARGE	[1]	999999

The bottom left corner of the screenshot shows a terminal window with the text 'JSD] > 11' and 'QAD] > 1'. The bottom right corner shows 'ids Division' and 'NETHERI & I'.

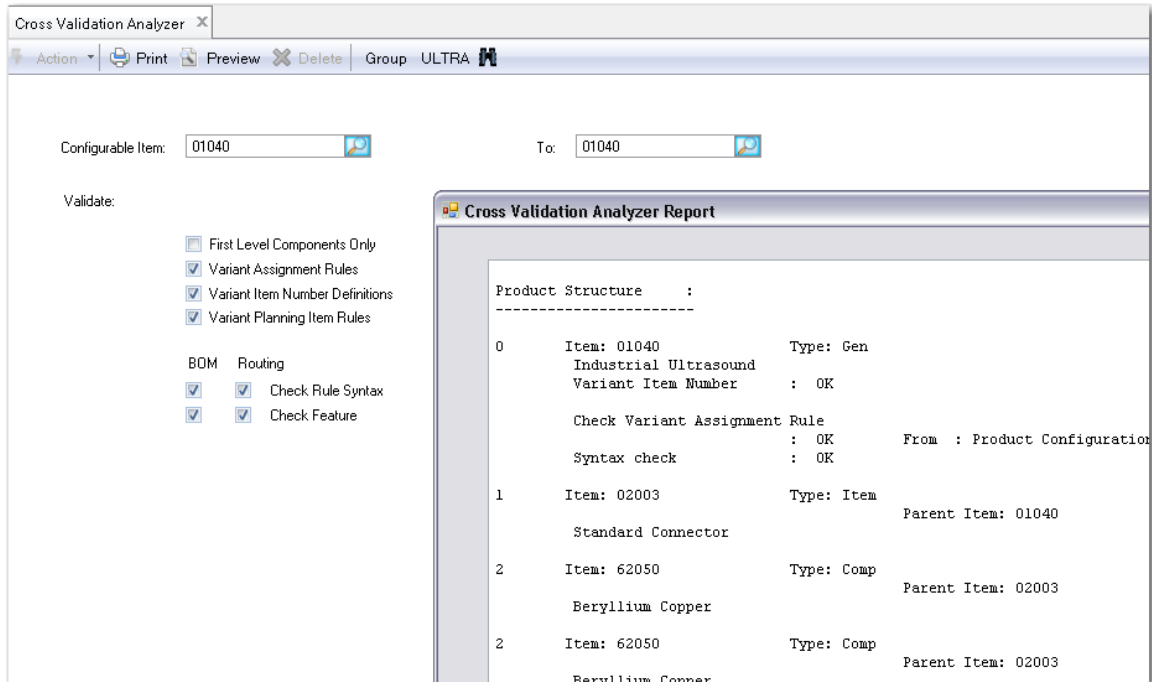

Run the Configuration Analyzer for the Industrial Ultrasound now. Review the report. If there are any errors, follow suggestions of the report and verify your setup.

Run the Cross Validation Analyzer for the Industrial Ultrasound as well. Leave all check boxes the way they are. Review the resulting report and solve the inconsistencies, if any.



# Configurator Questionnaire

There are two ways you can launch the questionnaire.

- Use Configurator Questionnaire.
- Select a configurable item in the order line in Sales Order Maintenance (7.1.1) or Sales Quote Maintenance (7.12.1) in the Sales Order/Invoices module. The Questionnaire window is automatically launched. Selecting a variant item in the order line does not trigger the product configuration process.

The process of configuring a variant item consists of three phases:

- You answer the questions in the questionnaire.
- QAD Configurator stores these answers as a configuration in the QAD Configurator database.
- QAD Configurator creates a variant item, variant product structure and/or a variant routing and stores it in the QAD Enterprise Applications database.

The questionnaire coordinates the whole process.

## Questionnaire Sequence Maintenance

Configuration Analyzer determines the question sequence in the questionnaire. Questionnaire Sequence Maintenance lets you manually rearrange the questions.

### Exercise 27: Questionnaire Sequence Maintenance

Feature	Data Type	Question Type	Description
U-OUTPUT	Logical	NORMAL	ADDS A PRINTER TO THE UNIT
U-COVER	Logical	NORMAL	ADDS A KEYBOARD COVER
BACKUP	Logical	NORMAL	ADDS AN EMERGENCY BATTERY BACKUP
BACKUP-TYPE	Text	NORMAL	SPECIFIES TYE TYPE OF BATTERY BACKUP

Run Questionnaire Sequence Maintenance and define the feature order.

### Exercise 28: Configurator Questionnaire

Run Configuration Questionnaire. Select the Industrial Ultrasound (01040), leave the Customer field blank and click the OK button. You can see a list of Configuration IDs of previously created configurations, along with their variant item number (if available) and some other characteristics. If there are no existing configurations, the list is empty.

Configuration Questionnaire X

**QAD Configurator [ULTRA] Customer: Item: 01040 Description: Industrial Ultrasound**

Standard Configurations Existing Configurations Configure Item Configuration Summary

New Configuration

Search Select criteria... Select operator... To Search Clear

All existing configurations for Item 01040

Configuration ID	00005529	00005527	00005496	00005494	00005463
Variant Item	01040-190	01040-189	01040-187	01040-186	01040-185
Customer			10C1005	10C1005	
Status	F	F	F	F	F
Create date	03/27/14	03/27/14	03/21/14	03/20/14	03/20/14
User ID	mfg	mfg	demo	demo	demo
Description					
List Price (USD)	6,286.00	6,286.00	6,150.25	6,105.00	6,286.00
Net Price (USD)	6,286.00	6,286.00	6,150.25	6,105.00	6,286.00
Portable	Yes	Yes	Yes	Yes	Yes
Power converter	SMART	SMART	SMART	SMART	SMART
Battery backup	Yes	Yes	Yes	No	Yes
Backup type	ALKALINE	ALKALINE	ALKALINE	N.A.	ALKALINE
Frequency	500KHZ	500KHZ	500KHZ	500KHZ	500KHZ
CPU	STANDARD	STANDARD	STANDARD	STANDARD	STANDARD
Keyboard cover	Yes	Yes	Yes	Yes	Yes
Printer	Yes	Yes	Yes	No	Yes
Painted	PAINTED	PAINTED	STAINLESS	STAINLESS	PAINTED
Color	BLACK	BLACK	N.A.	N.A.	BLACK
Display type	TOP DISPLAY	TOP DISPLAY	TOP DISPLAY	FRONT DISPLAY	TOP DISPLAY
Length	100	100	100	100	100
Height	120	120	120	120	120
Width	80	80	160	160	80

Page 1 of 13 | Displaying 1 to 5 of 63 | Items per Page 5 | Cancel

Choose New Configuration. The window you are looking at now contains the actual questionnaire. The left section of the screen displays the questions specified using the programs in the Sales Configuration menu. On the right side, you can see a summary panel.

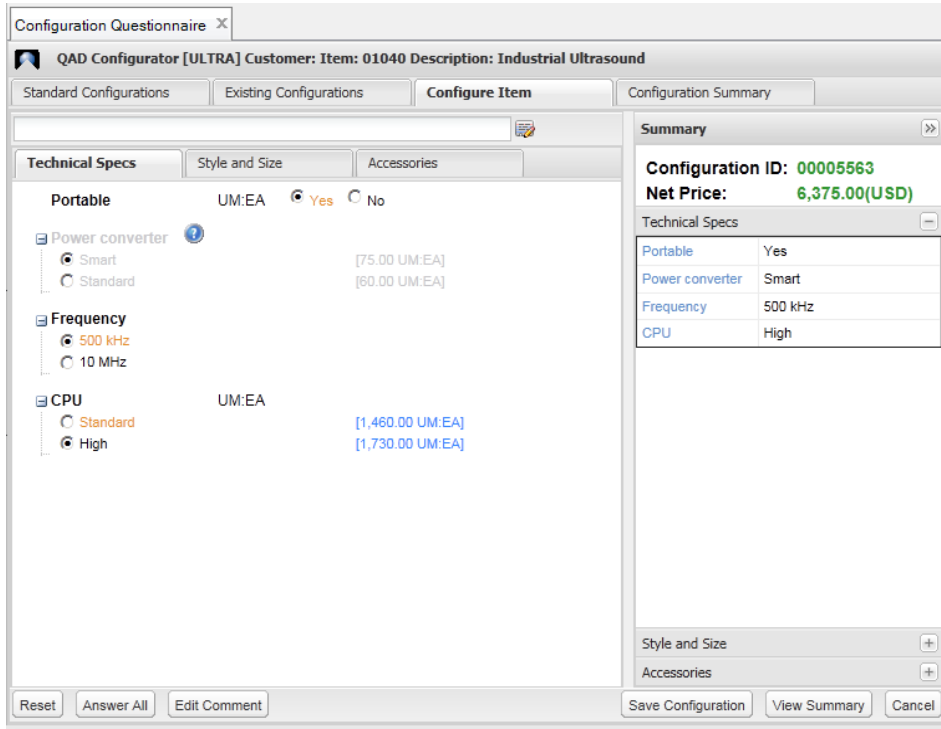

You can customize the questionnaire settings whether to display temporary and background questions. To customize the questionnaire, click the Customize icon next to the message bar in the Configure Item screen.

In the Configure Item screen, questions are grouped under corresponding functional group tabs.

**Note** When there are multiple language records for functional group names, option questions, option answers, and user messages, the questionnaire shows in the language of the user who runs the questionnaire.

As a questionnaire respondent, you can switch among different functional group tabs to view and answer questions. If no functional group is defined, all questions are listed under a single tab.

To automatically answer the questionnaire, click the Answer All button to answer all the questions using their default options. For questions with no default answers, the first option is used. Errors occur when you provide an invalid value for an answer or when your answer violates option dependency rules. In this case, an alert icon appears next to the question and the message bar displays relevant error messages. Fix all errors to successfully complete the questionnaire.

Now create a configuration by answering the questions. Note how the answer to one question can affect the list of feasible answers to other questions.

After you have answered all questions, click View Summary. In the Summary screen, you can review answers that you have provided, save your configuration, view similar configurations, and finally create a variant item based on your configuration.

All existing configurations for Item 01040			
Configuration ID	00005563	00005529	00005527
Variant Item		01040-190	01040-189
Customer			
Status	O	F	F
Create date	04/02/14	03/27/14	03/27/14
User ID	mfg	mfg	mfg
Description			
List Price (USD)	6,375.00	6,286.00	6,286.00
Net Price (USD)	6,375.00	6,286.00	6,286.00
Portable	Yes	Yes	Yes
Power converter	SMART	SMART	SMART
Battery backup		Yes	Yes
Backup type		ALKALINE	ALKALINE
Frequency	500KHZ	500KHZ	500KHZ
CPU	HIGH	STANDARD	STANDARD
Keyboard cover			

To submit your completed configuration, click the Save Configuration button at the bottom of the Configuration Summary screen. A new configuration record is created with a new configuration ID.

**Note** Different combinations of configuration-selection, auto-select, and configuration-retention values in Configurable Item Maintenance determine how the system behaves when a configuration is saved and how variant items are created.

Your current configuration is displayed on the left of the Existing Configurations screen with all the configurable item questions and the answers you have provided.

Create a variant from your new configuration by clicking the C icon on the Variant Item row.

## Exercise 29: Verifying the structure of the Variant Item

Now check whether the data resulting from the configuration process has been stored correctly in the QAD Enterprise Applications database.

Run Product Structure Inquiry (13.6) in the Manufacturing module.

Enter the item number of the created variant of the Industrial Ultrasound (01040). Verify that the correct items have been selected from the generic product structure by comparing the items to the answers and the selection rules that you entered. Also verify that the weights have been rolled up in the new item master, according to the exercise on Element Roll-Up Rule Maintenance.

Run Routing Maintenance (14.13.1) in the Manufacturing module to check that the system has selected the correct operations. Also check that the routing comments have been updated for the variant of item 50010.

### Exercise 30: Starting the Questionnaire from Sales Order Maintenance

Run Sales Order Maintenance (7.1.1) in the Sales Orders/Invoices module. Enter a new sales order for your selected customer. When you get to the sales order line, enter 01040 in the Item Number field. The system automatically launches the questionnaire.

### Exercise 31: Examining the Questionnaire

Run Configuration Questionnaire. Enter item number 01040 but leave the Customer field blank. Click OK. Choose New Configuration to create a configuration. Now you see the questionnaire. By answering the questions in the list, you are defining the characteristics of the product.

**Note** The exact characteristics depend on the set of exercises you went through. If you skipped some of them, the questionnaire can look different to the one discussed here.

The questionnaire has the following characteristics:

- The current group (Master Group Maintenance) and the item for which the questionnaire is run are shown in the title bar of the screen. So is the customer when the questionnaire is launched from Sales Order Maintenance or Sales Quote Maintenance.
- Although the questionnaire is run for item 01040, it also shows the questions associated with the features of item 50020. The questions for lower level configurable items are always collected.
- The questions are ordered according to the feature sequence you specified. However, due to dependencies resulting from the rules you entered, the system can also change the question sequence.
- The questions appear on different tabs. The tabs correspond to the functional groups assigned to the features. Features that do not have an assigned functional group are displayed on the No Group tab.
- Place the cursor over the Question icon to display the rules that apply to a feature.
- Click the Customize icon next to the message bar in the Configure Item screen. You can customize the questionnaire settings to display temporary and background questions as well, and show questions in the long question format.
- The variable housing-area is a temporary variable. A temporary variable gets value from a rule. If there is no specific rule, the system uses the default value as the answer to the associated question. You can use this kind of variable to let the system calculate a value in the background that you want to have available when you are running the questionnaire. To display temporary variables on the questionnaire, select the Show Temporary Questions check box in the Customize window.

## Exercise 32: Show Existing Configurations Option

The screenshot shows the 'Configurable Item Maintenance' window. At the top, there is a toolbar with 'Action', 'Print', 'Preview', 'Delete', and 'Group' buttons. The 'Configurable Item' field contains '01040' and a 'New' button. The 'Description' is 'Industrial Ultrasound' and the 'SO Type' is 'BOM'. There is a 'Lock Configurable Item' checkbox. The 'Analyzed On' date is '4/2/2014 6:27:46 AM' with an 'Analyze' button.

The 'Configuration Creation Rule' section includes:
 

- Variant P/M: M, Configurable P/M: M
- Configuration Selection: Select Last Matching, Auto Select checkbox
- Configuration Retention: No Duplicates
- Variant Item-Site Record: None
- Site Variable: (empty field)

The 'Configurator Questionnaire' section includes:
 

- Show Existing Configurations: Second (dropdown menu with options: First, Second, On request, No)
- Show All Options Of Feature: checked checkbox

The 'Cost' section includes:
 

- Variant Item Cost Roll-Up: checked checkbox
- Cost Set: Standard (dropdown)

The 'Pricing' section includes:
 

- Calculate Configuration Price: checked checkbox
- Allow Net Price Change: unchecked checkbox
- Allow Manual Price List Change: unchecked checkbox
- Store All Pricing Information: checked checkbox
- Create a Price List: checked checkbox
- Customer Specific List Price: checked checkbox
- List Price Variable: LIST-PRICE (text field)
- Net Price Variable: NET-PRICE (text field)

At the bottom, there is a 'Language' field, a 'Comment' field, and 'Cancel', 'Save', and 'New' buttons.

You can customize the configuration process using the Show Existing Configurations option in Configurable Item Maintenance. Its value determines whether and how the Existing Configurations screen is displayed in the questionnaire. The following options are available:

- First: Display existing configurations on launching the questionnaire.
- Second: Display the new configuration on launching the questionnaire.
- On request: When launching the questionnaire, display a message asking the user whether to show existing configurations.
- No: Hide the Existing Configurations tab in the questionnaire.

Experiment with this feature and select your preferred value.



# Pricing

The pricing functionality calculates the price of a configuration while you are defining the configuration in the questionnaire. In this way, you base your answers on the price of the configuration as it is at that moment.

In many situations, the price of a configuration is equal to the sum of the prices of its components. Now suppose that each component is only chosen if a certain option is selected as an answer (a one-to-one relationship between the options and the components). Instead of assigning a price to a component, an alternative approach is to assign a price to the associated option and sum the prices of the options. QAD Configurator uses the approach of assigning a price to an option.

To assign a price to an option, define a pricing part for the option. QAD Configurator uses the price and price lists (if any) of this pricing part to find the best net price and the best list price of the feature option. Any item can serve as a pricing part. QAD Configurator uses the standard QAD Enterprise Applications “best pricing” engine to determine the best list and net price of a pricing part.

If selecting an option leads to selecting more than one unit of a component, then you want to incorporate the quantity information to pricing.

For numeric and numeric list features, you can select the Quantity Based check box in Variable Maintenance or Feature Maintenance. If you do not select this check box, the system only adds one unit of the component to the configuration.

For all other types of features, the Quantity Based check box is not available. In these cases, you can use a pricing rule. The pricing rule is a special type of rule, in which the pricing quantity (pricing\_qty) attribute of the feature is set. QAD Configurator interprets the value of this attribute as the number of units of the component. If you do not define a pricing rule, the quantity is one.

The pricing functionality offers many more possibilities:

- You can assign any price to an option by specifying a dummy item and using that item as a pricing part for the option.
- If a pricing part is not the component that is selected when you choose an option, then the number of units is not the number of units of the actual component. It is the number of units of the item that serves as the pricing part. In fact, the pricing quantity is only for finding a price in a price list and thus it does not even have to refer to units selected in the variant product structure. In other words, you can force the price of a configuration to go up when a certain option is selected, without selecting the component.

- If one or more components are always selected, independent of the answers given, then you can define a separate price or separate price lists. The separate price lists contain total prices of this collection of items and link them to a dummy item. Then you can use this dummy item as a pricing part. Make sure that the price is always incorporated in the price of the configuration. For example, you can define a rule to always select the relevant option of this dummy feature.
- If choosing a certain option means that more than one different component is selected, then you can create a price or price lists. The separate price lists contain prices of the collection of components and link them to the pricing part that you associate with the option.

Also provide a pricing unit of measure. The pricing unit of measure is often expressed associated with the pricing quantity. See the following example. If:

- The unit of measure of an item or a price list is gram
- and the unit of measure entered in Configurator is kilogram

Then:

- A pricing quantity of 2 in the questionnaire means a quantity of 2 kilograms

So far we have discussed pricing part, pricing quantity, quantity based, and unit of measure. You enter pricing part, quantity based, and unit of measure in Variable Maintenance and Feature Maintenance. In general, the data entered in Feature Maintenance is used, but there are two exceptions to this rule:

- If Std Options is selected in Feature Maintenance, the data from the variable option is used.
- If the feature is a logical and the answer in the questionnaire is equal to no, then QAD Configurator uses 0 as the price for the feature. If the answer is yes, then QAD Configurator uses the pricing information as specified in Feature Maintenance.

In Configurable Item Maintenance, you can set how the pricing functionality works.

**Note** The price of the configuration shown in the questionnaire is always the price of one unit of the configuration.

When QAD Configurator creates a variant item, it also stores two new price lists in the QAD EA database:

- the best list unit price of the variant item
- the best net unit price of the variant item

QAD Configurator needs the information in these price lists to complete fields on the sales order line.

## Pricing: Use Pricing Without Pricing Rules

### Exercise 33: Use Pricing Without Pricing Rules

Variable Option Maintenance

Option: ALKALINE

Description:

Detail Comment

Short Answer: ALKALINE

Long Answer: FOUR ALKALINE BATTERIES WILL BE INCLUDED FOR BATTERY BACKUP

Qty Based

Pricing Part: 60021 UOM: EA

Save New Cancel

Before you enter the data, read the flow of the exercise:

- Calculate the price of a variant of item 01040. We base the price of a variant item on the technical specifications, the style, and the accessories selected to illustrate the pricing functionality.
- To include the steel that is used to build the housing in the price of the variant item, we assign pricing parts to the variables steel-large and steel-small. As these variables are numeric, select the Quantity Based check box in Variable Maintenance. In this way, QAD Configurator interprets the value entered in the questionnaire as the number of units of the component.
- The prices of the remaining features are incorporated by linking the respective items as pricing parts to the options that can be in the questionnaire.
- This exercise does not contain pricing rules. The use of pricing rules is illustrated in the next exercise.

The items which are used in this example have selling prices defined in Item Master Maintenance.

**Note** QAD Configurator supports best pricing so you can also use Price List Maintenance (1.10.1.1) in the Master Data module to define list prices and discounts for pricing parts.

Run Variable Maintenance and add the following pricing information to the variables:

Variable	Pricing Part	UM	Quantity Based
steel-large	60091	EA	Selected
steel-small	60090	EA	Selected

Run Variable Maintenance and add the following pricing information to the existing options:

Variable	Option	Pricing Part	UM
backup-type	Alkaline	60021	EA
	NiCd	60023	EA
	Lithium	60022	EA
CPU	High	60052	EA
	Standard	60050	EA
Freq	500kHz	50002	EA
	10MHz	50001	EA
Portable	Yes	60005	EA
Power	Smart	60089	EA
	Standard	60088	EA
U-color	Black	60061	GL
	White	60020	GL
	Standard	60062	GL
U-cover	Yes	60015	EA
U-output	Yes	60008	EA

**Note** Run Feature Maintenance to specify pricing information for the feature options that do not have Std Options selected. It is not necessary to Run Feature Maintenance in this exercise because all the feature options we are using for pricing have Std Options selected.

Run Variable Maintenance and define two new numeric variables in which the total best list unit price and the total best net unit price of the configuration can be stored.

Variable	Data Type	Extent	Question/Temporary	Question Type	Functional Group
list-price	Numeric	1	Question	Special	Technical Specs
list-price	Numeric	1	Question	Special	Technical Specs

Now run Configurable Item Maintenance. Select the Industrial Ultrasound (item 01040) and enter the following data:

Item	Calculate Configuration Price	List Price Variable	Net Price Variable
01040	Selected	list-price	net-price

The last two entries tell QAD Configurator to store the best list unit price and the best net unit price of the configuration in the variables list-price and net-price respectively. QAD Configurator automatically converts the variables list-price and net-price to features of the item so you do not have to link them to an item yourself first. You can use these features for all kinds of purposes. For instance, for calculations or to assign one of these prices to the Price field of the variant item (using Variant Item Data Rule Maintenance).

Run the Configuration Analyzer for item 01040.

Run Variant Item Data Rule Maintenance. The system stores the best net price of the configuration in the pt\_price field of the variant item by entering the following assignment rule.

Item	Field	Assignment Rule
01040	pt_price	net-price

Now run Configuration Questionnaire for item 01040 and select New Configuration.

Answer the questions for frequency, CPU, portable and the accessories. While you do so, check the following:

- View the Summary pane. The price of the configuration in the Summary pane changes when questions on the frequency, CPU, portable, or on the accessories are answered. The price is updated.
- The price of the configuration in the Summary pane only increases by the price of one unit of the selected battery. The product structure states that four batteries are required. A later exercise deals with the price of multiple batteries.
- Even though the question type of the features net-price and list-price is normal, these two features are not displayed in the questionnaire.
- Click the Customize icon next to the message bar in the Configure Item screen. A Customize screen appears. Experiment with the different values in the Price Type list.
  - List Price: Displays the best list price of the pricing part associated with the current option multiplied by the current value of the pricing quantity.
  - Net Price: Displays the best net price of the pricing part multiplied by the current value of the pricing quantity.
  - Discount: Displays the discount percentage for the option. The discount in the Summary pane displays the discount percentage for the total configuration including only the questions that are answered.
  - Manual Price List: Displays the ID of any manual price lists that have been selected. Manual price lists are covered later in the training.
- The price of the configuration displayed in the questionnaire is always the price of one unit of the configuration.

Now make sure that Price Type is set to Net Price, answer all questions, memorize the price of the configuration as shown in the Summary pane, and create a variant item.

Finally, run Item Master Inquiry (1.4.2) in the Master Data module for the created variant item. Check that the net price of the configuration is now stored in the Price field of the variant item.

Some points to be aware of:

- If you start the questionnaire from the sales order line and enter the quantity, the field values of List Price, Discount and Net Price fields are for one item unit.
- The price displayed in the Summary pane can differ from what you expect because unseen background features (if any) can have pricing information as well.
- You can view the temporary and background features by selecting the Show Temporary Questions and Show Background Questions check boxes in the Customize screen.
- It is not compulsory to enter a variable in the List Price Variable and Net Price Variable fields in Configurable Item Maintenance. If you do not enter anything, the best list unit price and the best net unit price of the configuration are still calculated and displayed in the Summary pane but not stored.

## Pricing: Use Pricing With Pricing Rules

You can compose pricing rules for text, date, logical, and element type variables. A pricing rule is a special type of rule that sets the value of the attribute `pricing_qty` of a feature. Use pricing rules to set quantity for non-numeric features. In these rules, the right side of the THEN, ELSE, or ASSIGN statement does not contain an option. Instead, they contain a numeric feature or a formula that yields a numeric value.

### Exercise 34: Pricing with Pricing Rules

The screenshot shows the 'Item Rule Maintenance' window. The 'Rule ID' is 'IR-005'. The 'Description' field is empty. Under 'Rule Detail Edit', the 'Assignment' dropdown is set to 'Assignment'. The rule is configured as 'Assign BACKUP-TYPE Pricing Qty = 4'. The 'Preview' section shows 'ASSIGN: BACKUP-TYPE:pricing\_qty = 4'. A 'Check Syntax' button is present, and the status is 'Passed'. The 'Update' and 'OK' buttons are also visible.

Now create a pricing rule for the batteries (items 60021, 60022 and 60033). In the generic product structure of 01040 each battery has a product structure quantity of 4. In other words, when a battery is selected in the questionnaire, the price of four batteries is added to the configured price.

Run Item Rule Maintenance and enter the following rule.

Item	Rule ID	Rule
01040	IR-005	Assign backup-type:pricing_qty = 4

Start the Configuration Analyzer and analyze item 01040.

Now run Configuration Questionnaire for item 01040 and select New Configuration.

Answer the questions for backup and battery type.

- The batteries have a pricing quantity of 4.
- The option N.A. does not have a linked pricing part and therefore does not have a price.

## Pricing: Numeric List Example

Assume the product structure of item 01040 has ten Alkaline, six Nickel Cadmium, and four Lithium Sulphur batteries. In this scenario, we want the price of these batteries in the configuration price. One approach is to use a numeric list type variable where the variable options specify the required quantities.

### Exercise 35: Pricing With Numeric Lists

Run Variable Maintenance and create the following variable.

Variable	Data Type	Extent	Functional Group	Question Type	Short Question	Question/ Temporary
battery-type	Numeric List	1	Accessories	Normal	Battery Type	Question

Enter the following values on the Variable Options tab

Seq	Option	Short Answer	Pricing Part	Qty Based	UM
1	10	Alkaline	60021	Selected	EA
2	6	NiCadmium	60023	Selected	EA
3	4	Lithium	60022	Selected	EA
4	100	N.A		Not selected	

Run Feature Maintenance and make this new variable a feature of item 01040.

**Note** Select Std Options so the variable options are copied to the feature.

Run Item Rule Maintenance and enter the following rule.

Item	Rule ID	Rule
01040	IR-010	If backup = No then battery-type = 100 else battery-type <> 100

Start the Configuration Analyzer and analyze item 01040.

Now run Configuration Questionnaire for item 01040 and select New Configuration.

Answer the questions for backup and battery type.

- The batteries have a pricing quantity of 10, 6 and 4.
- The option N.A. does not have a linked pricing part and therefore does not have a price.

**Note** The purpose of this exercise is to provide an example of a numeric list type variable and the quantity-based pricing function. You can delete item rule IR-010 and feature battery-type as they are no longer needed in this training.

## Pricing: Allow Net Price Changes

The check box Allow Net Price Change in Configurable Item Maintenance enables you to change the calculated net price for an option while you run the questionnaire.

### Exercise 36: Net Price Changes

Run Configurable Item Maintenance. Select the Industrial Ultrasound (item 01040) and select the check box Allow Net Price Change. Leave the other data intact.

Item	Allow Net Price Change
01040	Selected

Start the Configuration Analyzer and analyze item 01040.

Now run Configuration Questionnaire for item 01040 and select New Configuration.

Click the Customize icon next to the message bar in the Configure Item screen. A Customize screen displays. Make sure that Price Type is set to Net Price.

Answer the questions that determine the pricing, for instance frequency, CPU and backup type. While you do so, check the following:

- The net price is displayed next to the feature option. This net price field contains the unit net price of the pricing part associated with the option.
- You can change the value of the net price manually. Move the cursor over the net price field and double-click. A Pricing window displays. You can update the Net Price field in the Pricing window.

The new net price value is included in the Net Price in the Summary pane when the question is answered.

## Pricing: Manual Price List Selection

In Configurable Item Maintenance, the check box Allow Manual Price List Change enables you to select a manual price list for an option when running the questionnaire. If the manual price list is valid for the pricing part, QAD Configurator considers this price when it determines the best prices. Otherwise, QAD Configurator disregards the manual price list and uses the other applicable price lists to calculate the best prices.

### Exercise 37: Manual Price List Selection

Use Price List Maintenance (1.10.1.1) to define the following price list. Item 60015 is the pricing part for the keyboard cover.

Price List	Item/Analysis Code	Currency	Amount Type	Quantity Type	Comb Type	Manual	Min Qty	Net Price
MPM60015	60015	USD	Net Price	Quantity	Base	Selected	1	145.00

Run Configurable Item Maintenance and select Allow Manual Price Change. Leave the other data intact.

Item	Allow Manual Price Change
01040	Selected

Now run Configuration Questionnaire for item 01040 and select New Configuration.

Go straight to the question for the keyboard cover in the questionnaire. The manual price list is available for the keyboard cover Yes option.

Feature	Option	Manual Price List
Icemaker	Yes	MPM207

Move the cursor over the net price field of the Yes option of the keyboard cover and double-click. A Pricing window appears. The pricing Window now contains a Manual Price List field. Select the appropriate manual price list. The system considers the selected manual price list and calculates a new net price. Click the Save button in the pricing window to accept the new net price.

## Pricing: Store All Pricing Info

In Configurable Item Maintenance, the check box Store All Pricing Information controls whether to store pricing information for all options or only the pricing information of the chosen options in a configuration.

- If you do not select Store All Pricing Information, only the best net unit price and the best list unit price are stored in the database.
- If you select Store All Pricing Information and create a configuration, both prices are stored for all possible options of all features. So if there are many options, the database can grow fast and can cause performance problems.

Therefore, normally you do not select Store All Pricing Information.

Chapter 7

# **Additional Subjects**

## Configurable Item Data Copy

You can use Configurable Item Data Copy to copy the features and rules attached to an existing configurable item to another configurable item in the same group.

### Exercise 38: Configurable Item Data Copy

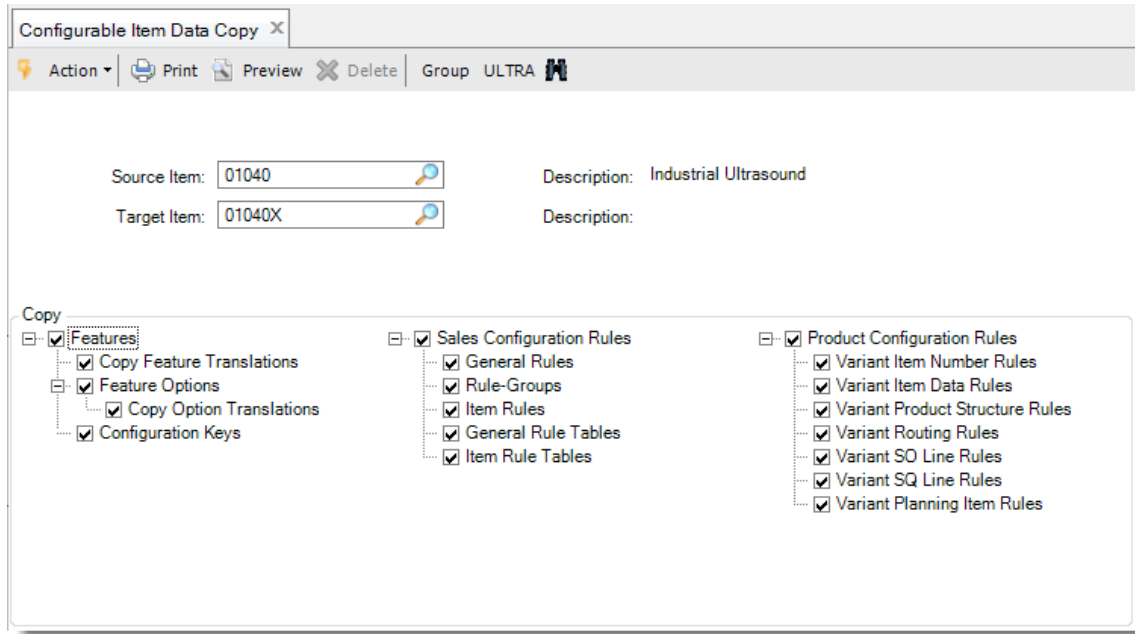

Use Item Master Copy (1.4.12) in the Master Data module and copy item 01040 to item 01040X.

Run Configurable Item Maintenance and define a new configurable 01040X.

Now run Configurable Item Data Copy to copy all the features and rules from 01040 to the new configurable item.

Source Item	Target Item
01040	01040X

**Note** To view the feature translations you are about to copy, you can use Feature Language Browse. To view the feature option translations you are about to copy, you can use Feature Option Language Browse.

Then activate some of the reports or menu programs to check the result of the copy function.

**Note** Fields in the source configurable item, such as Configuration Selection, Show Existing Configurations and Cost Set, are not copied to the target item. Use Configurable Item Maintenance to set fields in the target configurable item.

## Displaying Warning Messages in the Questionnaire

When constructing sales configuration rules, you can define warning messages to display when a particular rule condition is met during the questionnaire entry process.

To define a warning message:

- 1 Define a logical type variable.
- 2 Create a sales configuration rule and assign the following function to the logical variable:

```
showMessageBox(title, message)
```

Where *title* is the title of the warning message box and *message* is the warning message you want to display.

You can enter the message box title and the message in any of the QAD supported languages.

**Example** You define a message and the message box title in Chinese.

**Fig. 7.1**  
Define Message in Chinese

```
ASSIGN:  
LOGICAL03 = if (&CFG-PREFIX)UserLanguage = "CH" then  
showMessageBox("测试", "测试规则异常")
```

Then when the Chinese questionnaire respondent uses the questionnaire, the system displays the message box title and the message in Chinese.

**Fig. 7.2**  
Message Shown in Chinese



- 3 Attach the rule to an item. When the system processes the rule in the questionnaire, a warning message appears.

### Exercise 39: Warning Message in the Questionnaire

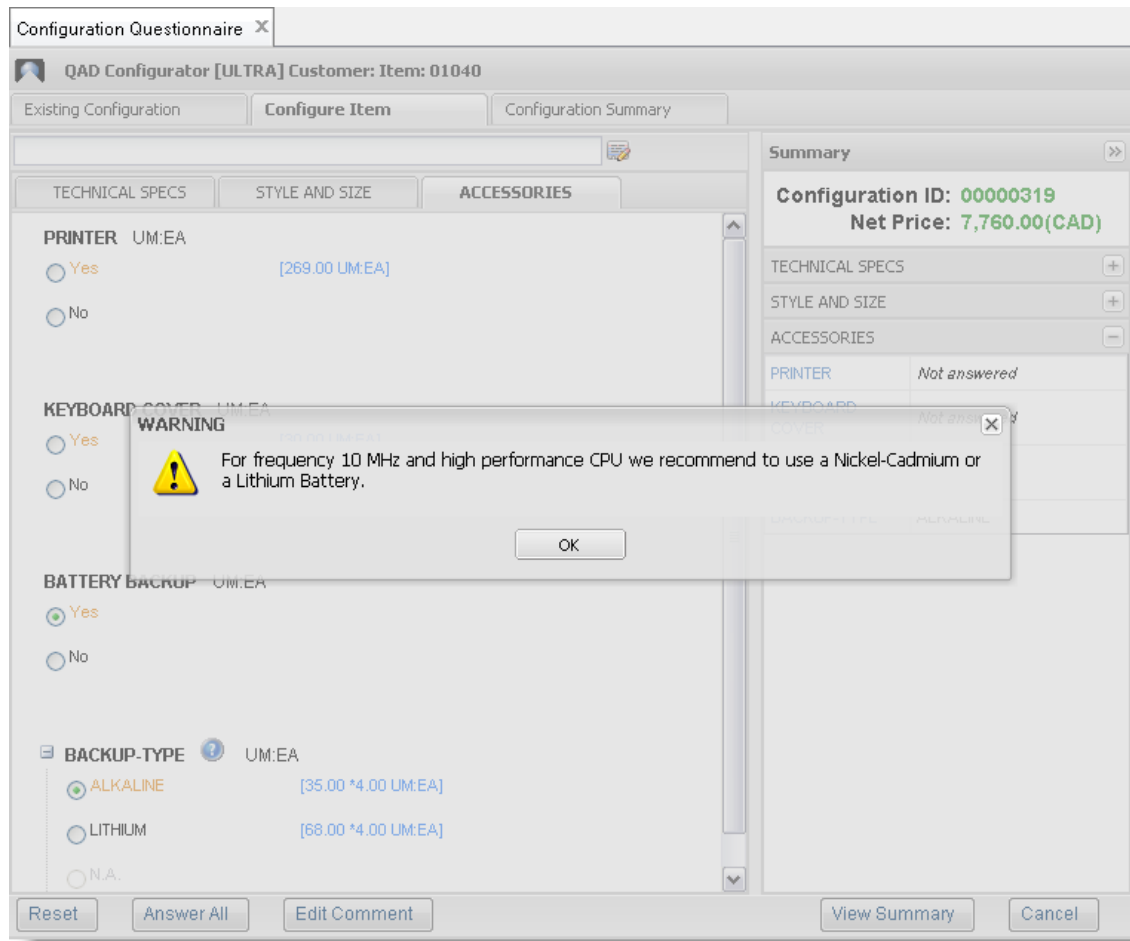

Run Variable Maintenance and create the following variable.

Variable	Data Type	Extent	Functional Group	Question Type	Short Question	Question/ Temporary
mess-var	Logical	1	Technical Specs	Normal	mess-var	Temporary

Run Feature Maintenance and assign this variable to configurable item 01040.

Run Item Rule Maintenance and enter the following rule.

Item	Rule ID	Rule
01040	IR-006	If freq = "10MHz" and CPU = "high" and backup-type = "Alkaline" then mess-var = showMessageBox ("WARNING", "For frequency 10MHz and high performance CPU, use a Nickel-Cadmium or a Lithium Battery.")

Now run the Configuration Analyzer for item 01040.

Run the questionnaire for item 01040 and select New Configuration.

Select Frequency equals 10MHz, CPU equals high, and Backup Type Alkaline. The system displays the warning message "For frequency 10MHz and high performance CPU, use a Nickel-Cadmium or a Lithium Battery."

**Note** The warning message does not prevent the user from continuing.

## Variant Item-Site Records

In Configurable Item Maintenance, the Variant Item-Site Record field specifies whether to create item-site data with item master records. The options are:

- **None:** The variants are non-site-specific; no variant item-site data are created.
- **Current Site Only:** The system generates variant item-site data specific to a particular site. If you choose this option, specify a valid site variable for creating item-site data in the Configuration Questionnaire. This variable is specified in the Site Variable field in Configurable Item Maintenance.
- **All Sites:** The system generates variant item-site data specific to all the sites associated with the configurable item as defined in Item-Site Planning Maintenance.

When you create variant items at the end of the configuration process, the system creates the variant item data.

**Note** During variant item creation, the system only copies the item site planning data from the configurable item to the variant. Item-site inventory and cost data are not copied. It is recommended that you leave the item cost and inventory fields blank when you set up data for a configurable item. During variant item creation, inventory and cost data can be automatically calculated by roll-up.

The variant item data depends on the Variant Item-Site Record option you choose for the current configurable item.

### Exercise 40: Variant Item-Site Records

Your company has decided to manufacture high frequency ultrasounds in site 10-100 and lower frequency ultrasounds in site 10-201. Sales orders for these industrial refrigerators continue to be taken in site 10-100.

Run Item-Site Planning Maintenance (1.4.17) in the Master Data module and add an item-site record for the configurable item 50020 for site 10-201. This configurable item-site record is the template for the variant item-site records.

Run Variable Maintenance and create the following variable.

Variable	Data Type	Functional Group	Question Type	Short Question	Question/Temporary	Variable Options or Data Format
config-site	Text	Style and Size	Normal	config-site	Temporary	10-100 10-201

Now run Configurable Item Maintenance and update the following items:

Item	Variant Item-Site Record	Site Variable
01040	All Sites	
50020	Current Site Only	config-site

**Note** QAD Configurator automatically converts the variable config-site to a feature of the configurable item. Run Feature Maintenance to ensure that the variable options are copied to the features. When you select Use Standard Options, the system automatically copies the variable options to the features.

Assign freq as a feature of 50020, so that you can use it in an item rule for 50020 (it currently is only a feature of configurable item 10040). Run Item Rule Maintenance and add the following rule for item 50020.

Item	Rule ID	Item-Specific Rule
50020	IR-502	If freq = "10Mhz" then config-site = "10-100" else config-site = "10-201"

Start the Configuration Analyzer and analyze item 01040.

Run the questionnaire for item 01040 and select New Configuration. Complete the questionnaire and create a variant item.

Run Item-Site Planning Inquiry (1.4.8) in the Master Data module and verify that system created item-site records for the variant items.

## Element Variables

An element variable is directly associated with a field in a database table. You can see a variable of the element type. But in the background, QAD Configurator changes the type so that the value of the variable can be compared to the value in the database. Comparisons require identical data types. QAD Configurator supports element variable links to two types of entities:

- internal entities, which are defaults in QAD Configurator.
- external entities, which you define in External Entity Maintenance.

The following tables in the QAD Enterprise Applications database are internal entities:

- Item Master
- Customer Master
- Sales Order Master
- Sales Order Detail
- Sales Quote Header
- Sales Quote Detail

External entities are covered in the next section.

### Exercise 41: Element Variable and Internal Entities

Use an element variable to select specific information from the Item Master record associated with configurable item 01040 and display it in the questionnaire.

Run Variable Maintenance and create the following variable.

Variable	Data Type	Extent	Functional Group	Question Type	Short Question	Question/ Temporary
confitemdesc	Element	1	Technical Specs	Normal	Item Description	Question

Enter the following values on the Data Format Tab.

Variable	Element Type	Entity	Field
confitemdesc	Internal	Configurable Item	pt_desc1

Run Feature Maintenance and make this new variable a feature of the 01040.

Run Questionnaire Sequence Maintenance and make item-desc the first feature on the Technical Specs tab.

Now run the Configuration Analyzer for item 01040. Solve any inconsistencies, then run the questionnaire for the Industrial Ultrasound. Select New Configuration.

## External Entity Maintenance

This function allows you to select specific information from the QAD EA database or from the QAD Configurator database or any other connected database and to use it in the questionnaire. An external entity is a reference to a record in the database. After defining an entity, you can create a variable of the type element, and link this variable to the external entity.

### Exercise 42: External Entity Maintenance

Suppose that you want to show the ID and description of the product line of that item on the questionnaire.

Find the description of the product line in the field `pl_prod_line` of the `pl_mstr` table in the QAD EA database. You cannot access the `pl_mstr` table in QAD Configurator. So you define an external entity.

Once the database and the table are determined, you need a selection rule to select the correct record. In this example, select the record where `pl_mstr.pl_prod_line` equals the product line number of the Industrial Ultrasound.

To specify the selection rule, you need another variable in which you store this product line number. This variable must be of the type element and must refer to the configurable item and to the product line field.

First run Variable Maintenance and define the following variable.

Variable	Data Type	Extent	Functional Group	Short Question	Question / Temporary	Question Type
pline-id	Element	1	Technical Specs	Product Line ID	Question	Special

Enter the following values on the Data Format Tab.

Variable	Element Type	Entity	Field
pline-id	Internal	Configurable Item	pt_prod_line

Now run External Entity Maintenance and enter the data as follows.

External Entity	Database	Table	Selection Rule
pline	qaddb	pl_mstr	pl_prod_line = pline-id

**Note** You can use the Rule Assistant to enter the selection rule.

The next step is to run Variable Maintenance and add the following variable.

Variable	Data Type	Extent	Functional Group	Short Question	Question / Temporary	Question Type
pline-desc	Element	1	Technical Specs	Product Line	Question	Normal

Enter the following values on the Data Format Tab.

Variable	Element Type	Entity	Field
pline-desc	External	pline	pl_desc

Finally use Feature Maintenance to add the new variables to the Industrial Ultrasound.

Item	Feature
01040	pline-id
	pline-desc

Now run the Configuration Analyzer for item 01040.

Run the questionnaire for item 01040 and select New Configuration. See the product line description that is displayed on the questionnaire.

**Note** You can view the product line ID by selecting the Show Background Questions check box in the Customize screen.

## External Entity Rule Maintenance

Use External Entity Rule Maintenance to assign values to fields in databases defined as external entities.

## Configurable Item Maintenance Cost Roll-Up

Cost roll-up enables you to calculate the costs of manufacturing an item. Because QAD Configurator adds the product structure of any items that you configure to the QAD Enterprise Applications database, the cost roll-up functionality is incorporated in QAD Configurator as well.

Calculating the costs for an item involves adding the following five types of costs:

- Material costs
- Labor costs
- Burden costs
- Subcontract costs
- Overhead Costs

The roll-up of the total costs consists of a routing cost roll-up and a product structure cost roll-up. Refer to the relevant QAD Enterprise Applications user guides for a detailed description of routing and product structure cost roll-up.

During configuration of a variant, QAD Configurator calculates the costs of manufacturing the item. To see these costs, run Product Structure Cost Report (13.12.4) in the Manufacturing module for items 01040, 50020 and the variant items. Enter the correct site (10-100) and the correct cost set (Standard).

You can also use Item Master Maintenance (1.4.1) in the Master Data module to see the costs associated with items.

## Element Roll-Up

As we have seen, you can use Element Roll-Up Maintenance to calculate non-cost data. The roll-up calculation is made during the process of creating a variant product structure and/or a variant routing and the outcome is stored in a field belonging to this variant.

Element Roll-Up allows us to execute a calculation afterwards — that is, after the variant product structure or routing has been created. For example, you want to change the original formula that was used in the calculation.

Before you can run Element Roll-Up, first define the element roll-up rules for configurable items. The input to Element Roll-Up can either be variant items or configurable items for which you want to update all variants.

## Manual Configuration Maintenance

Suppose that there are items in the QAD Enterprise Applications item and product structure tables that are valid variants (configuration descriptions), but which were not created using the QAD Configurator questionnaire. These variants do not have a configuration ID in QAD Configurator and can never be selected as existing variants. Using Manual Configuration Maintenance, it is possible to create this configuration description afterward and link it to the item in QAD Enterprise Applications.

Using Manual Configuration Maintenance is a way to enable QAD Configurator to substitute existing variants in a product structure, without going through analyzing and answering all the questions on the questionnaire.

## Configuration Rebuild

Over time, new features can be introduced, existing features can become obsolete, and product structures can change.

You can use Configuration Rebuild to make batch changes to multiple configurations and update variant items data without going through the questionnaire entry process. You can also reprice configurations as well as update variant product structures and routings for selected variant items during the rebuild process.

The Configuration Rebuild function does not create new variant items from existing configurations. For configurations without variant items, only features and price information can be updated.

The system runs the following product configuration rules when rebuilding a configuration:

- Variant item data rule
- Variant product structure rule
- Variant routing rule

Currently, the system does not process sales configuration rules during configuration rebuilds.

### Exercise 43: Configuration Rebuild

Sales of black ultrasounds have been disappointing and market analysis has indicated that gray is a more popular color. Your company's marketing department has decided to remove black as a standard color option and replace it with gray.

Run Configuration Browse to view your existing configurations. If you do not have a configuration with feature Color = Black, create one for this exercise. Run the Configuration Questionnaire and select New Configuration. Select Color = Black. Complete the questionnaire and create a variant item.

Run Feature Maintenance for configurable item 50020 (Industrial Housing) and update the feature housing-color as follows:

- Delete feature option Black.
- Add feature option Gray.

Use Item Master Maintenance (1.4.1) in the Master Data module to create the item as follows:

Item Number.	UM	Description	Net Weight & Measure	Pur/Mfg	Price	Standard Material Cost
60063	GA	Paint, Gray	1.0 KG	P	0.00	6.00

**Note** You could create item 60063 using Item Master Copy (1.4.12) and copying item 60061 (Paint, Black)

When gray paint is replacing black paint, do the following:

- Update the generic product structure.

- Update the affected product configuration rules.

Run Product Structure Maintenance (13.5) in the Manufacturing module to update the product structure for the Industrial Housing (50020). Delete component 60061 (Paint, Black) and add component 60063 as follows:

Level	Component Item	Description	Quantity Per	UM
Parent	60061	Industrial Housing		EA
1	60063	Paint, Gray	0.75	GA

Run Variant Product Structure Rule Maintenance for configurable item 50020 and enter the selection rules as follows:

Configurable Item	Component	Description	Selection Rule
50020	60062	Paint, Other	Painted = "painted" and u-color <> "white" and u-color <> "black" and u-color <> "gray"
	60063	Paint, Gray	Painted = "painted" and u-color = "gray"

Now update the existing configurations that have Color = Black.

Run Configuration Rebuild.

- Select configurable item 01040.
- A Configuration Browse window is displayed. Use the search box to filter records and look up the configurations where Color = Black. Click OK to select all the configurations displayed in the browse.
- To make batch changes to features in all the selected configurations, select Feature Options. In the expanded box, specify the feature changes during the rebuild process. Select Add/Update and assign housing-color = Gray.
- Select the Product Structure/Routing check box to update the product structures and routings of the variant items. Next specify whether you want to obsolete or delete the old product structures and routings.
- Select Show Detail to display detailed change information in the rebuild report.
- Click Rebuild. The system displays the number of configurations and variant items to rebuild. Click OK to start the rebuild process.

Run Configuration Browse to view your existing configurations. Verify that the configurations that previously had Color = Black now have Color = Gray.

## Forecasting Configurable Items

Some companies have a requirement to forecast configurable items to effectively drive MRP. When a confirmed sales order line for a variant item is created, the system consumes the forecast of a configurable item.

The recommended approach is to create a planning item (an item with Pur/Mfg set to F) that represents a configurable item. This planning item would have the forecast for the associated configurable item. For example, 01040 is a configurable item and 01040-P is the associated planning item. Variant Planning Item Rule Maintenance is used to link a configurable item to a planning item.

For the system to consume forecast of a planning item, variant items must be components of the planning item’s product structure. When a new variant item is created using the Configuration Questionnaire, the system adds the variant item to the product structure of the associated planning item.

A variant item is added to the planning bill as a component with the following values:

- Structure Type is P (planning)
- Forecast Percent is zero to prevent MRP from generating planned orders for the components of the variant item from the forecast of the planning item.
- Quantity Per is 1

Because Structure Type is P, the system consumes the forecast of the planning item with the variant item order quantity on the sales order line when the sales order line is confirmed.

The planning bill can also contain components from the generic product structure of the configurable item. Set up these components with Structure Type O (option). Then set Forecast Percent to the required value.

### Exercise 44: Forecasting a Configurable Item

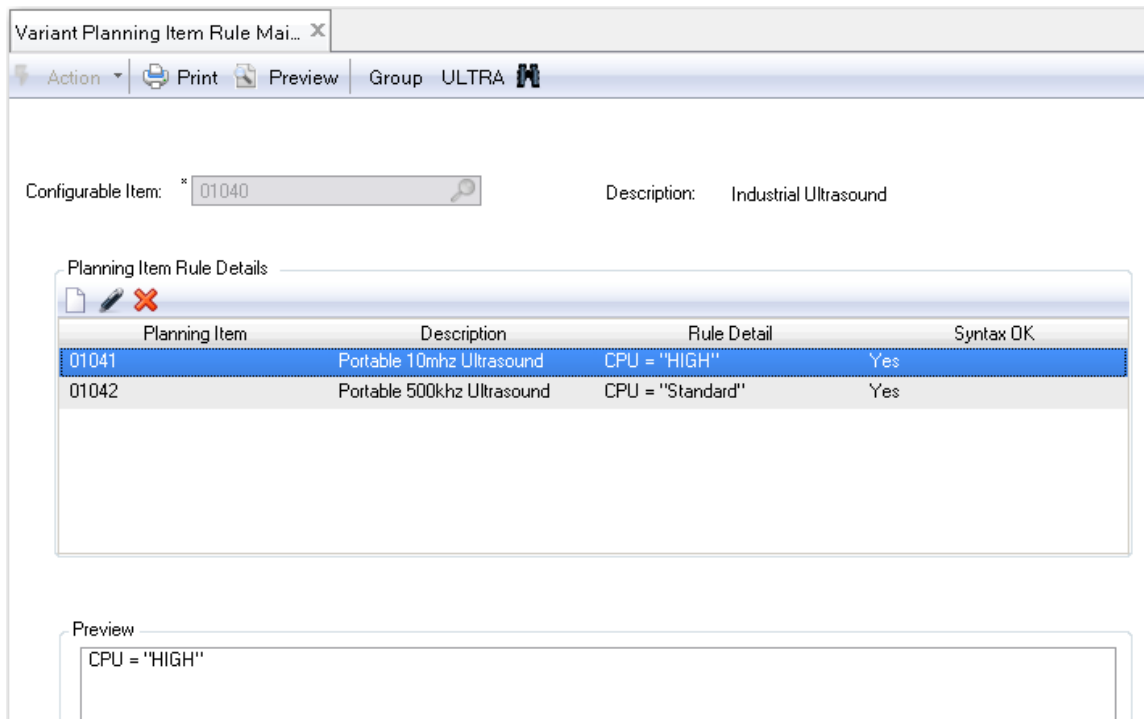

Use Item Master Maintenance (1.4.1) to create the item as follows:

Item Number	UM	Description 1	Description 2	Pur/Mfg
01040-P	EA	Industrial Ultrasound	Planning Item	F

Run Forecast Maintenance (22.1) in the Manufacturing module and enter a forecast for item 01040-P. Create this forecast in the default site of item 01040-P. Forecast a quantity of 100 a week for this week and the next 3 weeks.

Now use Variant Planning Item Rule Maintenance to link the configurable item 01040 to its associated planning item. Leave the selection rule blank.

Configurable Item	Planning Item
01040	01040-P

Run Sales Order Maintenance (7.1.1). Enter a new sales order for your selected customer. When you get to the sales order line, enter 01040 in the Item Number field. The Questionnaire automatically starts. Select New Configuration, complete the questionnaire, and create a variant item. Order a quantity of 5 and complete the sales order line. Ensure that Consume Forecast is selected on the sales order line.

Run Forecast Maintenance (22.3). Verify that the system has consumed the forecast of 01040-P by the quantity ordered on the sales order line.

Run Product Structure Inquiry (13.6) in the Manufacturing module and view the product structure of planning item 01040-P.

## Deleting and Archiving Configurations

Each time you complete the questions in the questionnaire and click OK, QAD Configurator generates a new configuration in the database, containing all the answers to the questions for the configurable item. The configuration is created even if no variant is generated. As a consequence, the configuration table in the QAD Configurator database can grow rapidly

You can use Configuration Delete/Archive to archive one or more configurations to a file for later use, or permanently delete configurations from the set of configurations available in QAD Configurator.

This function lets you limit the set of available configurations in your QAD Configurator session by storing old configurations in a file or deleting them. If you create configurations regularly, the configuration table can grow rapidly. QAD Configurator cannot access the configurations in the file.

**Warning** If you do not enter any configuration IDs or variant numbers, QAD Configurator archives/deletes all the available configurations in the group.

## Batch Compiler

While running, QAD Configurator uses temporary code tables based on the product configuration selection and quantity rules. In this way, QAD Configurator uses the most recent version of the rules. Normally, the variant generator, which is incorporated in the questionnaire, checks the validity of the files and creates new ones if necessary.

If there is doubt as to the validity of the objects, for example, after a database rebuilding, you can use Batch Compiler to re-create all code files.

## Rule Table Accelerator

Use Rule Table Accelerator to make an indexed search on one or more rule tables possible. When you accelerate a rule table, the accelerator stores additional information needed for the indexed search in the database. Suppose that you use General Rule Table Maintenance to delete a rule table, and that you accelerated this same table sometime in the past. If QAD Configurator not only deleted the rule table itself, but also started searching the database for obsolete information due to the deletion, the deletion can take quite some time. To avoid this, Rule Table Accelerator rather than General Rule Table Maintenance is responsible for deleting this information. It starts searching the database and deleting the information as soon as it has finished accelerating the tables you specified.

Rule Table Accelerator can operate on general rule tables or on item rule tables but it cannot accelerate both types of tables at the same time.

## Configurator Reports

Most of the reports offer a way to get an overview of the information you entered in the associated function. A report makes it easier to compare the data. Besides, a report makes it possible to collect only data that meets certain selection criteria.

### Exercise 45: Configurator Reports

Now experiment a little with the various Configurator reports yourself.



Appendix A

# **QAD Enterprise Applications Setup**

## QAD Enterprise Applications Setup

Domain: 10USA > 10USACO

Items used in the training:

Item Number	UM	Description	Net Weight & Measure	Pur/Mfg	Price	Standard Material Cost
01040	EA	Industrial Ultrasound	7.24 KG	C	4,570.00	0.00
02003	EA	Standard Connector	0.048 KG	M	2.34	0.00
50001	EA	Probe Unit - 10Mhz	0.00 KG	M	1,320.00	0.00
50002	EA	Probe Unit – 500kHz	0.00 KG	M	1,045.00	0.00
50020	EA	Industrial Housing	0.00 KG	M	0.00	67.95
60001	EA	Durable Plastic Housing	0.00 KG	P	0.00	127.00
60003	EA	Keyboard	0.20 KG	P	55.00	55.00
60005	EA	Battery	0.00 KG	P	255.00	2.35
60008	EA	Printer	1.50 KG	P	269.00	12.50
60015	EA	Keyboard Cover	0.10 KG	P	30.00	24.00
60020	EA	Cooling Fan	0.00 KG	P	0.00	75.00
60021	EA	Battery Backup, Alkaline	0.00 KG	P	150.00	2.50
60022	EA	Battery Backup, Lithium	0.00 KG	P	252.00	5.00
60023	EA	Battery Backup, NiCd	0.00 KG	P	180.00	3.50
60050	EA	Base Unit / CPU	0.00 KG	P	1,460.00	375.00
60052	EA	High Performance CPU	0.00 KG	P	1,730.00	390.00
60060	GA	White Paint	1.00 KG	P	0.00	6.00
60061	GA	Black Paint	1.00 KG	P	0.00	6.00
60062	GA	Paint, other	1.00 KG	P	0.00	6.00
60080	EA	Power Cord - UK	0.00 KG	P	15.00	13.00
60081	EA	Power Cord - Australia	0.00 KG	P	15.00	13.00
60082	EA	Power Cord - USA	0.00 KG	P	15.00	13.00
60083	EA	Power Cord - Universal	0.00 KG	P	15.00	13.00
60088	EA	Power Converter-Standard	0.35 KG	P	0.00	47.50
60089	EA	Power Converter – Smart	0.35 KG	P	0.00	47.50
60090	EA	Small Sheet Steel	1.65 KG	P	0.00	23.04
60091	EA	Large Sheet Steel	1.95 KG	P	0.00	68.00
60093	EA	Stainless Steel Sheet	6.10 KG	P	0.00	2.50
90093	EA	Shipping Carton	0.00 KG	P	00.00	0.85

## In Product Structure of the Industrial Ultrasound (01040):

Level	Component Item	Description	Quantity Per	UM
Parent	01040	Industrial Ultrasound		EA
1	02003	Standard Connector	2.0	EA
1	50001	Probe Unit - 10Mhz	1.0	EA
1	50002	Probe Unit – 500kHz	1.0	EA
1	50020	Industrial Housing	1.0	EA
1	60001	Durable Plastic Housing	1.0	EA
1	60003	Keyboard	1.0	EA
1	60005	Battery	1.0	EA
1	60008	Printer	1.0	EA
1	60015	Keyboard Cover	1.0	EA
1	60020	Cooling Fan	1.0	EA
1	60080	Power Cord - UK	1.0	EA
1	60081	Power Cord - Australia	1.0	EA
1	60082	Power Cord - USA	1.0	EA
1	60083	Power Cord - Universal	1.0	EA
1	60050	Base Unit / CPU	1.0	EA
1	60052	High Performance CPU	1.0	EA
1	60021	Battery Backup, Alkaline	4.0	EA
1	60022	Battery Backup, Lithium	4.0	EA
1	60023	Battery Backup, NiCd	4.0	EA
1	60088	Power Converter-Standard	1.0	EA
1	60089	Power Converter – Smart	1.0	EA
1	90093	Shipping Carton	1.0	EA

## Product Structure Maintenance of the Industrial Housing (50020).

Level	Component Item	Description	Quantity Per	UM
Parent	50020	Industrial Housing		EA
1	60060	White Paint	1.0	GA
1	60061	Black Paint	1.0	GA
1	60062	Paint, other	1.0	GA
1	60090	Small Sheet Steel	1.0	EA
1	60091	Large Sheet Steel	1.0	EA
1	60093	Stainless Steel Sheet	1.0	EA

## Work Center Maintenance:

Work Center	Machine	Description
1000		General Assembly
1020		Fabrication
1050		Product Test
1060		Pack
2310		E-Coat Paint Line 1

## Operations for Routing Code 01040 and 50020.

Routing Code	Operation Number	Work Center	Machine	Description of Operation	Setup Time	Run Time
01040	10	1000	1001	Assemble components	10.0	40.0
	20	1050	1001	Test finished unit	2.0	5.0
	30	1060		Pack for shipping	0.5	2.0
50020	10	1020		Cut steel	0.5	0.2
	20	1020		Assemble housing	0.5	0.5
	30	1020		Weld housing	0.5	0.5
	40	2310		Paint	0.5	0.5

# Product Information Resources

QAD offers a number of online resources to help you get more information about using QAD products.

[QAD Forums \(community.qad.com\)](http://community.qad.com)

Ask questions and share information with other members of the user community, including QAD experts.

[QAD Knowledgebase \(knowledgebase.qad.com\)\\*](http://knowledgebase.qad.com)

Search for answers, tips, or solutions related to any QAD product or topic.

[QAD Document Library \(www.qad.com/documentlibrary\)](http://www.qad.com/documentlibrary)

Get browser-based access to user guides, release notes, training guides, and so on; use powerful search features to find the document you want, then read online, or download and print PDF.

[QAD Learning Center \(learning.qad.com\)\\*](http://learning.qad.com)

Visit one-stop destination of QAD for all courses and training materials.

\*Log-in required

