



# Installation Guide QAD QXtend

78-0952-1.8-Rev1  
QXtend 1.8

MFG/PRO eB, eB2, eB2.1, QAD 2007, QAD Enterprise Applications Standard and Enterprise Editions  
June 2012

This document contains proprietary information that is protected by copyright and other intellectual property laws. No part of this document may be reproduced, translated, or modified without the prior written consent of QAD Inc. The information contained in this document is subject to change without notice.

QAD Inc. provides this material as is and makes no warranty of any kind, expressed or implied, including, but not limited to, the implied warranties of merchantability and fitness for a particular purpose. QAD Inc. shall not be liable for errors contained herein or for incidental or consequential damages (including lost profits) in connection with the furnishing, performance, or use of this material whether based on warranty, contract, or other legal theory.

QAD and MFG/PRO are registered trademarks of QAD Inc. The QAD logo is a trademark of QAD Inc.

Designations used by other companies to distinguish their products are often claimed as trademarks. In this document, the product names appear in initial capital or all capital letters. Contact the appropriate companies for more information regarding trademarks and registration.

Copyright ©2012 by QAD Inc.

Qxtend\_IG\_v0108-Rev1.pdf/biw/biw

**QAD Inc.**

100 Innovation Place  
Santa Barbara, California 93108  
Phone (805) 566-6000  
<http://www.qad.com>

# Contents

<b>Change Summary</b> .....	<b>vii</b>
<b>Chapter 1 QXtend Overview</b> .....	<b>1</b>
Introduction .....	2
QXtend .....	2
QXtend Deployment .....	2
QXtend Deployment Tiers .....	2
QAD QXtend .NET UI AppShell Plug-in .....	3
Deployment Options .....	4
QAD Deployment Configuration Service .....	4
QDCS Information Hierarchy .....	5
QXtend Installation .....	6
<b>Chapter 2 System Requirements</b> .....	<b>7</b>
Overview .....	8
Software Requirements .....	8
Unzip Utilities .....	8
QXO Server Requirements .....	8
QXI Server Requirements .....	8
Third-Party Components .....	9
Client Requirements .....	10
Operating Systems .....	10
Installation User Account .....	10
<b>Chapter 3 Prerequisites</b> .....	<b>11</b>
Overview .....	12
Install the Windows Telnet Server .....	12
Install the Telnet Server .....	12
Register the Georgia SoftWorks Software .....	12
Configure Georgia SoftWorks .....	13
Install the Tomcat Application Server .....	14
Deployment Worksheet .....	14

## Chapter 4 Installing, Upgrading, and Migrating QAD QXtend . . . . 19

Overview . . . . .	20
Installer Limitations . . . . .	20
Installing, Upgrading, and Migrating QAD QXtend in a GUI Environment . . .	21
Prerequisites . . . . .	22
Start the Installer . . . . .	23
Prepare the Installation . . . . .	23
Specify Deployment Configuration Parameters . . . . .	24
Select Environment . . . . .	25
Specify Install, Upgrade, or Migrate . . . . .	25
Installing QXtend . . . . .	26
Advanced Installation . . . . .	27
Upgrading QXtend . . . . .	37
Migrating QXtend . . . . .	40
Review the Pre-installation Summary . . . . .	43
Review the Installation Summary . . . . .	44
Installing, Upgrading, and Migrating QAD QXtend in a Character Environment	44
Adding Additional QAD Enterprise Application Instances to QXtend . . . . .	46

## Chapter 5 Post-installation, Post-upgrade, and Post-migration Tasks 47

Post-installation . . . . .	48
Logging In . . . . .	48
Enable SSL . . . . .	49
Verify QXO Server Installation . . . . .	51
Verify QXO Server and Source Application Connection . . . . .	52
Verify PROPATH and Event Recording . . . . .	53
Verify QXO Messages . . . . .	54
Check PROPATH for QXtend Adapter in .NET UI Scripts . . . . .	55
Post-upgrade . . . . .	55
QXtend Outbound Configuration . . . . .	55
Post-migration . . . . .	56

## Chapter 6 Troubleshooting QAD QXtend Installs, Upgrades, and Migrations 57

Overview . . . . .	58
Diagnosing the Problem . . . . .	58
Status . . . . .	58
Detailed Messages . . . . .	59
Detailed Errors . . . . .	59
Checking repository.xml . . . . .	60
Reading the Installation Log . . . . .	61
Environment Issues and Common Mistakes . . . . .	62

No X11 DISPLAY variable was set .....	62
Unable to Deploy .....	62
Cannot Connect to Database .....	62
Default Configuration .....	62
No Features to Install on this Host .....	63
IATEMPDIR Space .....	63
Java Memory .....	63
UI API Adapter Performance .....	64
Known Issues .....	64
Installer Menu Items Difficult to Select .....	64
<b>Appendix A Typical Installation Parameters .....</b>	<b>65</b>
Overview .....	66
Tokens .....	66
Parameters .....	66
<b>Appendix B Default Configuration .....</b>	<b>73</b>
Overview .....	74
Default Configuration Process .....	74
<b>Appendix C Process Control .....</b>	<b>77</b>
Overview .....	78
Using Process Control .....	78
<b>Appendix D Adapter Program Usage .....</b>	<b>81</b>
Overview .....	82
Adapter Program Utilization .....	82
QXO Programs .....	82
QXI Programs .....	82
<b>Index .....</b>	<b>85</b>



# Change Summary

The following table summarizes significant differences between this document and previous versions.

<b>Date/Version</b>	<b>Description</b>	<b>Reference</b>
June 2012/QXtend 1.8	Updated the Progress OpenEdge 10 version in QXO Server Requirements.	page 8
March 2012/QXtend 1.8	Added steps for the user to verify the .NET UI connmgr and telnet scripts have the QXtend adapter in PROPATH.	page 55
September 2011/QXtend 1.7.2	Rebranded for QXtend 1.7.2	---
	Documented Use OpenEdge DBMAN check box	page 26
	Documented Update Conmgr Properties check box	page 26
	Documented QXtend installer reminder feature	page 44
	Added new QXtend Post-migration section	page 56



# QXtend Overview

This section contains basic topics that you should understand before attempting a QAD QXtend installation or upgrade.

***Introduction*** 2

***QXtend*** 2

***QXtend Deployment*** 2

***QAD Deployment Configuration Service*** 4

***QXtend Installation*** 6

## Introduction

This chapter provides an overview of QXtend, QXtend deployment, the QAD Deployment Configuration Service, and QXtend installation.

## QXtend

The QAD QXtend interoperability framework provides a standardized data interface between QAD products and between QAD products and external systems.

The framework consists of two components:

- QAD QXtend Outbound (QXO) exports business objects as QDocs from QAD products, such as QAD Enterprise Applications and QAD JIT Sequencing (JIT/S), to external subscribers.
- QAD QXtend Inbound (QXI) imports QDocs from external applications into QAD Enterprise Applications and other QAD applications such as JIT/S.

For details about configuring and implementing QAD QXtend, see *User Guide: QAD QXtend*.

## QXtend Deployment

The QAD QXtend application consists of several components. You can deploy these in various ways on different hosts, platforms, and architectures.

### QXtend Deployment Tiers

Figure 1.1 shows the QXI deployment tiers and their relationships.

**Fig. 1.1**  
QXI Deployment Tiers

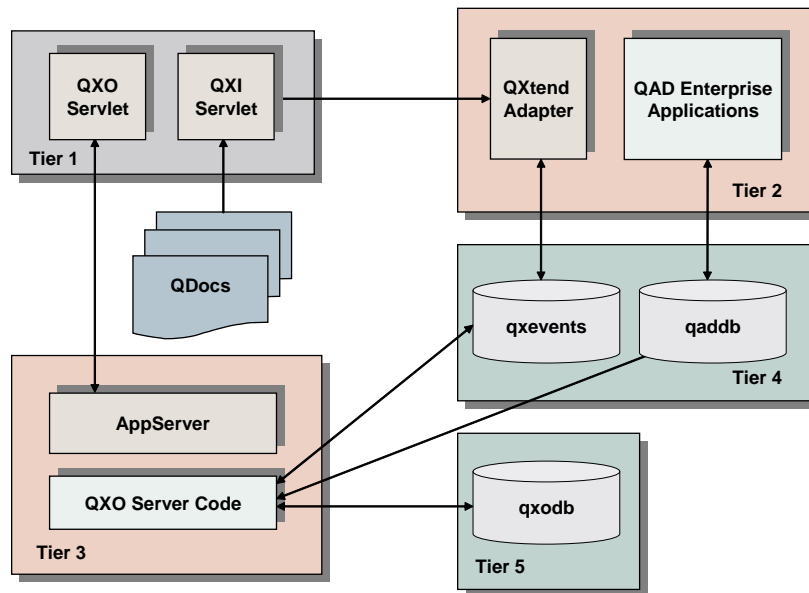

**Note** This deployment description uses tiers for explanatory purposes. While the grouping of components is significant, the numbering of the tiers is not.

The QXtend deployment consists of five tiers:

- Tier 1 consists of the QXI servlet and QXO servlet, which support the QXO administration UI and contains the Tomcat application server.

**Note** You can install the Inbound and Outbound servlets on the same Tomcat server or on a different Tomcat server.

- Tier 2 consists of the QXtend adapter code and the QAD Enterprise Applications server. You must install these components on the same host. The QXO adapter code generates outbound documents through the QAD Enterprise Applications user interface or through direct calls to API programs. The QXO service interface adapter code specifically supports interoperability involving requests originating from the QAD EE Financials module. You may need to deploy Tier 2 multiple times (once for each QAD Enterprise Applications installation).
- Tier 3 consists of the Progress AppServer and the QXO server code (the server code handles data operations for the qxevents, qadddb, and qxodb databases).
- Tier 4 consists of the qxevents database and qadddb production database. These databases communicate with the QXO server code and should be installed on the same tier for data integrity reasons.
- Tier 5 consists of the qxodb database. This database contains data extracted by the event service from the qxevents database.

The sequence for a single-tier deployment is as follows:

- 1 QXO servlet (tier 1)
- 2 qxodb database (tier 5)
- 3 qxevents and qadddb databases (tier 4)
- 4 QXO adapter code on the QAD Enterprise Applications Outbound server (tier 2)
- 5 QXO server code on the Progress AppServer (tier 3)

**Note** Tiers 2 and 4 (which contain the Adapter and QXEvents DB) can be multiplied according to the number QAD Enterprise Applications instances installed.

## QAD QXtend .NET UI AppShell Plug-in

Figure 1.2 shows the deployment of the QAD QXtend .NET UI AppShell plug-in.

**Fig. 1.2**  
QAD QXtend .NET UI AppShell Plug-in

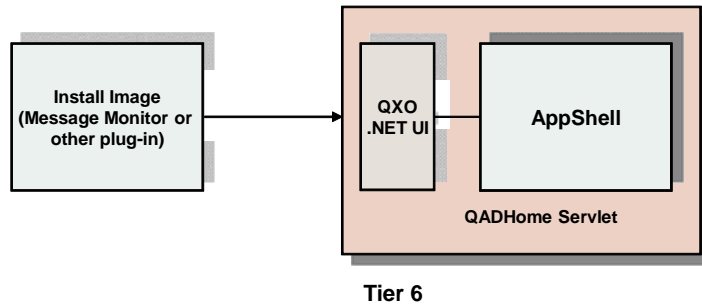

The QAD QXtend .NET UI AppShell plug-in deployment requires only one tier, consisting of the QXO .NET UI and the AppShell on the QADHome servlet. The AppShell supports various plug-ins designed to work with QAD applications (the QAD QXtend Message Monitor, for example).

## Deployment Options

The various components of QAD Enterprise Applications and QAD QXtend can be deployed in several configurations:

- On a single host in a unified deployment (single-tier deployment)
- On multiple hosts in a distributed deployment (multi-tier deployment)

In a single-host environment, all logical tiers are on the same host, and can therefore run at the same time. In a multiple-host environment, the logical tiers are separated physically by host. You must run the installer on each host involved in the installation.

## QAD Deployment Configuration Service

When installing QXtend, QAD recommends that you use the QAD Deployment Configuration Service (QDCS).

The QDCS is a repository that stores all of your deployment settings for QAD QXtend and its supporting third-party applications (Tomcat, for example) in a single place. Typically, the QDCS is stored on a network for easy access, but it also can be stored in a portable file. The QDCS is populated using the GUI installer. Therefore, access to a GUI environment is a prerequisite.

**Note** If you are installing in a Linux or UNIX environment and X-Windows is not available—or you are installing QAD QXtend in a character environment—you must first run the installer on Windows to collect the installation information.

There is only one repository QDCS regardless of the number of environments and/or hosts you plan to use in your deployment. *You only have to enter your deployment settings once into the QDCS for a particular configuration.* The service can be reused later, for example, to move a QAD QXtend deployment from a test environment into a production environment. See “QDCS Information Hierarchy” on page 5 for details about the structure of the QDCS.

Figure 1.3 illustrates how the QDCS works. The diagram assumes that all the QAD QXtend components and supporting third-party applications are being installed on the same host.

**Fig. 1.3**  
QDCS Information Flow

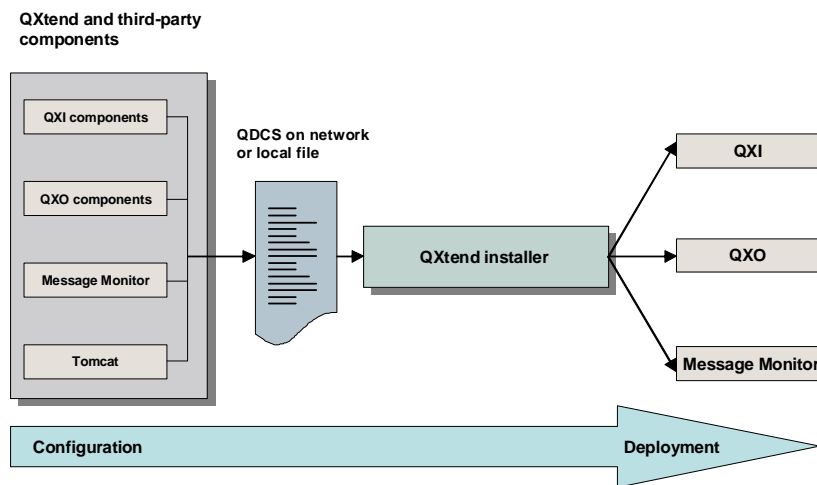

An installation using the QDCS consists of the following actions:

- 1 Specify the location of the QDCS: network or local host.
- 2 Specify the configuration file name and the environment name for the installation.
- 3 For each module you select to install (QXtend Adapter or QXI servlet, for example), provide the deployment configuration settings required by the installer. These settings are stored in the QDCS.
- 4 After you provide all of the settings for the selected components, review the installation summary before proceeding with the installation. The information stored in the QDCS guides the automated installation.

Installing QAD QXtend using the QDCS has the following advantages:

- For QAD QXtend components that share installation parameters (the location of the Progress AppServer, for example), the QDCS allows for the transfer of these settings between hosts. This reduces the potential for error when entering configuration information.
- The QDCS preserves deployment data across sessions. If the installation fails, you can resume the installation from the point where it stopped without re-entering the settings.
- Reinstallations need no further input.

## QDCS Information Hierarchy

The QDCS stores information in XML format in a hierarchy, as shown in Figure 1.4.

**Fig. 1.4**  
QDCS Information Hierarchy

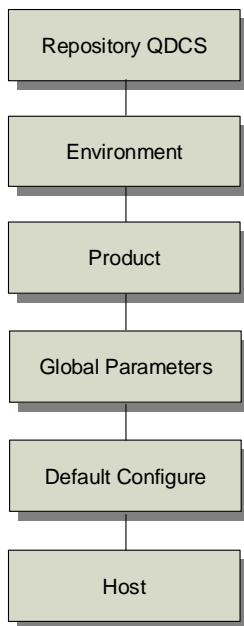

The repository QDCS hierarchy consists of the following elements:

- The repository QDCS element is at the top of the hierarchy. There is only one repository, regardless of the number of subordinate environments, products, and hosts.
- Typically, organizations have more than one environment. For example, your organization may have a test environment for verifying deployments, and a production environment that accommodates the live system. The position of the environment element at the secondary level in the QDCS hierarchy allows for the easy movement of product and host deployments between environments.
- Since the 1.7 release, the hierarchy has only contained two product elements. These elements are for QAD’s QXtend and Workflow products.
- Typically, there are several host elements. These enable the deployment of QAD QXtend in various configurations. Each host usually contains one or more QAD QXtend components determined by component dependencies and organizational deployment requirements.

## QXtend Installation

Installing and configuring QAD QXtend requires several prerequisite programs. This guide describes the installation and configuration of the QAD QXtend application on these programs.

**Note** See Chapter 2, “System Requirements,” on page 7 for additional information on requirements.

The steps are:

- 1 Install the prerequisite components.
- 2 Install QAD QXtend using the installer.

# System Requirements

This section provides the software, client, operating system, and other requirements for QAD QXtend.

**Overview** 8

**Client Requirements** 10

**Operating Systems** 10

**Installation User Account** 10

## Overview

This section provides the software, client, operating system, and other requirements for QAD QXtend.

**Note** For the most current requirements information, see the Product Availability Guide on the QAD Online Support Center at:

<http://support.qad.com>

## Software Requirements

This section describes the software needed to install, configure, and use QAD QXtend.

### Unzip Utilities

QAD's Download Center provides product downloads as compressed ISO files in .zip or .7z format. The .7z format is used to overcome a limitation that prevents the zipping of files larger than 2 GB.

To unzip .7z files, use the free 7-Zip utility. Windows, Linux, and UNIX versions of this utility are available from:

<http://www.7-zip.org>

Unzipping the compressed product file using the appropriate utility should yield an uncompressed ISO file.

### QXO Server Requirements

The following software must be present on the QXO server at the time of installation:

- A complete Progress OpenEdge 10 (10.2B or higher) installation including the following components:
  - Enterprise RDBMS
  - OpenEdge Application SVR Enterprise
  - Client Networking
  - OpenEdge Studio
- Java Software Development Kit, J2SDK, version 1.5x

### QXI Server Requirements

QXI requires prerequisite components and includes optional installations on the product media for other required products. A complete QXI installation requires:

- Progress OpenEdge 9.1E and above components including:
  - If your QAD Enterprise Applications installation is for a language other than US English, ensure you also install US English from the Progress media. The US English version of PROMSGS is needed for the telnet connection scripts.

- Latest Progress version-specific patches. For details, see the QAD Enterprise Applications installation guide for your system.
- QAD Enterprise Applications (MFG/PRO)
  - eB, SP4+
  - eB2, all versions
  - eB2.1 (QAD Enterprise Applications 2007), all versions
  - QAD Enterprise Applications Standard Edition
  - QAD Enterprise Applications Enterprise Edition

### Third-Party Components

- Additional Progress Components

In addition to the Progress software required for QAD Enterprise Applications, QXI requires the Progress AppServer, NameServer, and AdminServer if you use the code APIs.

- Apache Tomcat Application Server 5.5.20 or higher

This is available from:

<http://tomcat.apache.org/>

- Java 1.5.0 JDK (for Tomcat 5)

For Linux, Sun, and Windows versions:

<http://java.sun.com>

For Hewlett-Packard systems:

<http://www.hp.com/products1/unix/java/index.html>

For AIX systems:

<http://www.ibm.com/developerworks/java/jdk/aix/service.html>

- Telnet server

QXI uses a telnet server to run a pool of telnet sessions for communicating between QXI and QAD Enterprise Applications. On UNIX machines, you can use the default telnet service provided with the operating system.

For Windows systems, use:

Georgia SoftWorks Telnet Server 6.50+

This is available from:

<http://www.georgiasoftworks.com/>

### Supporting Technologies

QAD QXtend transparently incorporates several Web-based technologies. They are listed here to credit the open-source projects that created them.

- Struts is an open source framework for building Web applications and is part of the Jakarta Project, sponsored by the Apache Software Foundation.

<http://struts.apache.org/index.html>

- Apache AXIS is an implementation of the SOAP (Simple Object Access Protocol) submission to W3C.

<http://ws.apache.org/axis/>

- All QDoc requests and responses are logged using Log4j from Apache. Log4j is a reliable, fast, and flexible logging framework for Java.

<http://logging.apache.org/log4j/docs/index.html>

## Client Requirements

QAD QXtend client systems are browser-based and only require Internet Explorer, version 6.0+.

## Operating Systems

The QXI and QXO servers support the following platforms:

- Linux (Red Hat and SuSE)
- HP-UX
- HP-Tru64
- Sun Solaris (SPARC)
- Compaq UNIX (Tru64)
- IBM AIX
- Windows (including Windows 2000, 2002 Server, 2003 Server, XP, and 64-bit variants of these)

## Installation User Account

To avoid potential access permission problems, you must carefully select the user account used to install QXtend and the start environment. An easy way to prevent these issues is to use an administrator (rather than root) account to perform the entire installation. This includes starting Tomcat, installing QXtend, performing post-install activities, and starting the whole environment (QAD Enterprise Applications and QXtend).

# Prerequisites

This section describes the prerequisites that must be performed before QAD QXtend installation.

**Overview** 12

**Install the Windows Telnet Server** 12

**Install the Tomcat Application Server** 14

**Deployment Worksheet** 14

## Overview

Before installing QAD QXtend, you must do the following:

- Install the Windows Telnet Server (Windows only).
- Install the Tomcat Application Server.

## Install the Windows Telnet Server

For telnet connections on Windows servers, install the Georgia SoftWorks Telnet Server (GSWTS). You can download the latest version from the Georgia SoftWorks Web site at:

<http://www.georgiasoftworks.com/downloads.htm>

### Install the Telnet Server

- 1 Unzip the downloaded .zip file to a work directory.
- 2 In the work directory, double-click `setup.exe` to begin the installation.
- 3 At the Welcome window, click Continue.
- 4 Select Full Install and click Continue.
- 5 Enter the GSWTS installation directory and click Continue.
- 6 Use the default `\gs_uts` installation directory. You can place this directory on any network drive.
- 7 When GSWTS is installed, the Setup Succeeded window displays and GSWTS starts automatically.

### Register the Georgia SoftWorks Software

To register GSWTS, provide a product ID to Georgia SoftWorks so that a serial number can be generated for your product. The serial number identifies the server hardware and software components. If these components change or are upgraded, contact Georgia SoftWorks about generating a new product ID and serial number.

**Important** If you must reinstall or are planning to move your installation to a different platform, or if you are a sales agent or a distributor, include that information on the registration.

- 1 Select the Registration icon from the GSWTS program group in the Start menu.
- 2 Enter your customer information in the Georgia SoftWorks Product Registration window. The information displayed in the Product Information section is system generated.
- 3 Set Sessions Requested to 100. This is the number QAD automatically supplies with your registration.

**Fig. 3.1**  
Georgia SoftWorks Registration

- 4 Choose **Save to File** to save this information or choose **Print**. Then, follow the appropriate step to supply the product ID to Georgia SoftWorks:
  - a E-mail the saved registration form file to Georgia SoftWorks at:  
 registration@georgiasoftworks.com  
 When your form is received, a serial number is generated for your product and sent to you by e-mail.
  - b Fax the printed registration form to Georgia SoftWorks at 706-265-1020. When your form is received, a serial number is generated for your product and returned to you by fax.
- 5 When you receive your serial number, return to the Georgia SoftWorks Product Registration window, and enter it in the appropriate field in the registration form. Click **Register**.

## Configure Georgia SoftWorks

You must manually create the Georgia SoftWorks startup batch file, `k_start.bat`. In addition, if the QAD Desktop and QXI reside on the same host and use the same instance of Georgia SoftWorks, two `k_start.bat` files must exist. Each file is identified by a separate user directory under the `gs_uts\scripts` directory.

For this second case, there are multiple ways to set this up. See the Georgia SoftWorks documentation that downloads with the product in the `\docs` directory for details.

You must manually create the batch file to launch the Georgia telnet server. Open a text editor and enter the following:

```
@echo off
set gwn_term=1
set gwn_graphics=6
set gwn_color=0
set LRA_TERMINATION=SIG-CTRL-C,SLEEP5,SIG-CTRL-C,SLEEP5,F4,
SLEEP5,e,x,i,t,ENTER,SLEEP5,e,x,i,t,ENTER,SLEEP5,e,x,i,t,ENTER
C:
set prompt=$G
```

Make sure the drive designation, shown in the file sample above as `C:`, is the drive where you have installed Georgia SoftWorks.

Save the file as `k_start.bat` in the Georgia SoftWorks scripts directory, `GSWTSHome\scripts`. For example, `c:\GS_UTS\scripts`.

## Install the Tomcat Application Server

Install the Tomcat application server using the installation instructions provided in the *Tomcat User Guide* on the Apache Tomcat Web site.

## Deployment Worksheet

QAD recommends that you use the following worksheet to record information such as server names and locations, port numbers, and other settings before you start an installation. You enter these settings during installation configuration. For details, see “Installing, Upgrading, and Migrating QAD QXtend in a GUI Environment” on page 21.

**Table 3.1**  
Deployment Worksheet

Group	Description	Setting
General Install Configuration	Use QDCS network service? (Y/N) (Go to Local parameter file name if not using network service)	
	QDCS Tomcat host	
	QDCS Tomcat port	
	QDCS WebApp name	
	QDCS Tomcat admin user	
	QDCS Tomcat admin password	
	Local parameter file name (if not using QDCS)	
	Install log file	
	Environment name	
Tomcat	Tomcat home	
	Tomcat host	
	Tomcat admin user	
	Tomcat admin password	
	Tomcat port	
	Inbound WebApp name	
	Outbound WebApp name	
Migrate Inbound Configuration	Previous Inbound WebApp name	
	Tomcat directory	
	Previous Inbound version	

Table 3.1 — *Deployment Worksheet* (Page 1 of 4)

Group	Description	Setting
MFG/PRO	MFG/PRO version	
	MFG/PRO SP	
	MFG/PRO home	
	MFG/PRO PROPATH (xrc directory)	
	MFG/PRO database type (Progress or Other)	
	MFG/PRO database language	
	MFG/PRO database internal code page	
	MFG/PRO client stream codepage	
	MFG/PRO empty database directory	
	MFG/PRO qaddb empty database physical name	
	MFG/PRO admin empty database physical name	
	Additional connection parameters	
	Dataserver connection parameters (if data type is not Progress)	
	Progress for MFG/PRO	
	QDT directory (if applicable)	
	QDT environment name	
	Financial AppServer	
	Financial NameServer port	
	.NET UI home directory	
	QXtend Adapter	QXtend adapter destination directory
Client startup parameters		
Adapter Native API AppServer	Native API AppServer Name	
	Native API AppServer port	
	Native API AppServer max connections	
	Name server	
	Name server port	
	AdminServer port	
MFG/PRO Databases	MFG/PRO database host	
	MFG/PRO database directory	
	MFG/PRO database physical name	
	MFG/PRO database service name	
	MFG/PRO admin database physical name	
	MFG/PRO admin database directory	
	MFG/PRO admin database host	
	MFG/PRO admin database service name	
	MFG database start script	
	MFG database connection pf file	

Table 3.1 — *Deployment Worksheet* (Page 2 of 4)

Group	Description	Setting
QXEvents Database	QXEvents database physical name	
	QXEvents database directory	
	QXEvents database host name	
	QXEvents database service name	
	QXEvents database service port	
	QXEvents database block size	
	Progress directory for MFG/PRO databases	
Migrate QXEvents	Source QXEvents database physical name	
	Source QXEvents connection type	
	Source QXEvents directory	
	Source QXEvents host	
	Source QXEvents service name	
	Source QXEvents version	
Outbound Database	QXODB host name	
	QXODB destination directory	
	QXODB physical name	
	QXODB service name	
	QXODB Block Size	
	Progress for Outbound database	
Outbound Database (advanced parameters)	Before image	
	Schema area	
	Configuration data	
	Configuration indexes	
	Transactional data	
	Transactional indexes	
	Raw messages (CLOB)	
	Subscriber messages (CLOB)	
Migrate QXODB	Source QXODB database physical name	
	Source QXODB connection type	
	Source QXODB directory	
	Source QXODB host	
	Source QXODB service name	
	Source QXODB version	

Table 3.1 — *Deployment Worksheet* (Page 3 of 4)

Group	Description	Setting
Outbound Server	Outbound Server destination directory	
	Progress for Outbound server	
	Outbound UI AppServer name	
	Outbound UI AppServer port	
	Outbound UI AppServer maximum connections	
	Outbound SI AppServer name	
	Outbound SI AppServer port	
	Outbound SI AppServer maximum connections	
	AdminServer port	
	Name server	
.NET UI Plug-in	.NET UI version	
	.NET UI WebApp name	
	.NET UI Tomcat Port	
	.NET UI Tomcat Home	
	.NET UI configuration name	
	Include Inbound menu entry (Y/N)	
	Include Outbound menu entry (Y/N)	

Table 3.1 — Deployment Worksheet (Page 4 of 4)



# Installing, Upgrading, and Migrating QAD QXtend

This section describes how to install, upgrade, and migrate QAD QXtend in a GUI or character environment.

**Overview** 20

**Installer Limitations** 20

**Installing, Upgrading, and Migrating QAD QXtend in a GUI Environment** 21

**Installing, Upgrading, and Migrating QAD QXtend in a Character Environment** 44

**Adding Additional QAD Enterprise Application Instances to QXtend** 46

## Overview

The QAD QXtend installation disk contains the QAD QXtend installer, which supports GUI and character-based installs, upgrades, and migrations.

The QAD QXtend installation, upgrade, and migration options are as follows:

- Install, upgrade, or migrate in a GUI environment using the QDCS.
- Install or upgrade in a character environment using the QDCS. You first run the installer in a GUI environment to populate the QDCS with the required settings. See “Installing, Upgrading, and Migrating QAD QXtend in a Character Environment” on page 44.

**Note** You must have completed a successful installation before attempting to migrate the QXI servlet, QXO database, or QXO events database components.

The QXtend adapter, QXO servlet, and QXO server are code-based. There are no upgrade routines for these and they must be installed in place of the old version.

## Installer Limitations

Installation or upgrade does not update the startup scripts for QAD Enterprise Applications. You must manually update the scripts to include the locations of the newly installed components. For example, the new qxevents database must be included in the database set for QAD Enterprise Applications.

When migrating the QXO database configuration, the qxevents connection details are not automatically updated in the source application to point to the new version’s qxevents database installation. Before attempting to create any events, verify and update the connection details for each source application in QXtend Outbound.

Depending on the connection type defined for the qxevents database, the installer may be unable to connect to it. For example, if the connection specified is client-server and the server is down, the installer will not be able to connect to it at upgrade time.

If a qxevents connection problem occurs, the Dashboard in the QXO UI will not display. The screen will look something like Figure 4.1.

**Fig. 4.1**  
QXEvents Connection Error Indication

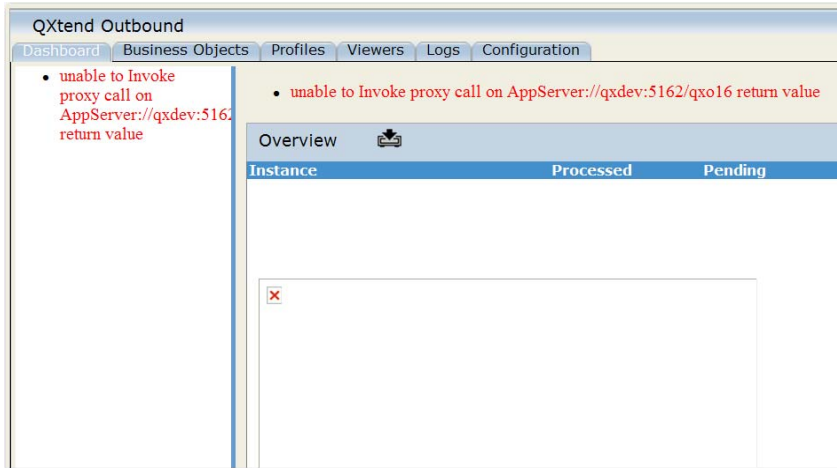

Also these messages will appear in the AppServer log for the QXO UI:

```
[09/04/02@14:52:42.296+1100] P-020654 T-000000 1 AS -- (Procedure: 'launchProcForSrcApps
connector.p' Line:638) ** CRC for ert_app_event does not match CRC in pl-msgconsol.p.
Try recompiling. (1896)

[09/04/02@14:52:42.296+1100] P-020654 T-000000 1 AS -- (Procedure: 'launchProcForSrcApps
connector.p' Line:638) Unable to locate index 'XPKevt_cnt' on table 'ert_evt_cnt' for
procedure 'pl-msgconsol.p'. (7967)
```

However, you will be able to navigate to the Configuration tab and update the database connection details for each of the source applications.

Workarounds exist for this issue. If you experience difficulties with your installation, see Chapter 6, “Troubleshooting QAD QXtend Installs, Upgrades, and Migrations,” on page 57. If you still experience problems, contact QAD Support for assistance.

## Installing, Upgrading, and Migrating QAD QXtend in a GUI Environment

This section describes the installation, upgrade, and migration of QAD QXtend using the QDCS on the same host in a Windows GUI environment.

Figure 4.2 summarizes the QAD QXtend installation, upgrade, and migration workflows.

**Note** The following sequence applies when all components are installed or upgraded on a single host. The deployment sequence may vary depending on your configuration.

**Fig. 4.2**  
QXtend Install, Upgrade, and Migration Workflows

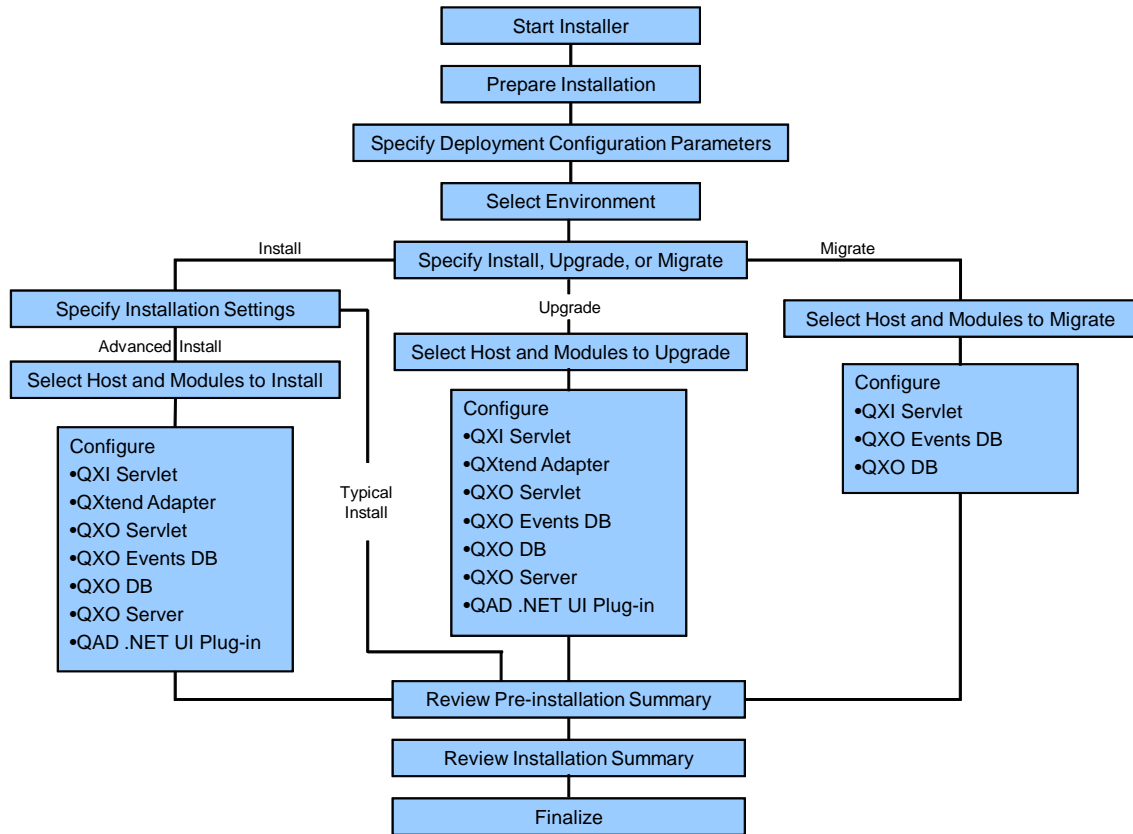

## Prerequisites

Before installing, upgrading, or migrating QAD QXtend, do the following:

- 1 QAD recommends that you shut down any virus protection programs. This can significantly reduce the time required for installation or upgrade and implementation.
- 2 Verify that Tomcat is running.
- 3 Verify that you have the appropriate folder permissions to perform the install, upgrade, or migration.
- 4 To use the GUI installer from an X-Windows session in a Linux or UNIX environment, set the DISPLAY variable using the following command:

```
export DISPLAY=HOST_NAME:0.0
```

For example:

```
export DISPLAY=plli13:0.0
```

- 5 If you are installing QXtend from QAD physical product media, go to “Start the Installer” on page 23.

Otherwise, download the ISO file from the QAD Download Center, unzip it using the appropriate utility (see “Unzip Utilities” on page 8), and go to “Start the Installer” on page 23.

## Start the Installer

- 1 Insert the release media into the CD-ROM drive or mount the release media image on your file system.
- 2 Navigate to the executable files. The executable files for each environment type are located under `Disk1/InstData/<env_type>/[No]VM/QXtend.[bin|exe]`.

**Note** If you choose to copy the files from the release media, make sure the directory structure remains the same, including the folder called `Disk 1`. If this is changed, the installer will not run. The directory structure should be as follows:

```
<CD MEDIA>
  +Disk1
    +InstData
      -Resource1.zip
      -MediaId.properties
      +{environment type}
        +NoVM
          QXtend.[bin|exe]
        +VM
          QXtend.[bin|exe]
```

## Prepare the Installation

- 3 If you have downloaded the installer, double-click `QXtend.exe`.  
The installer is extracted and the Introduction screen displays.

**Fig. 4.3**  
Introduction Screen

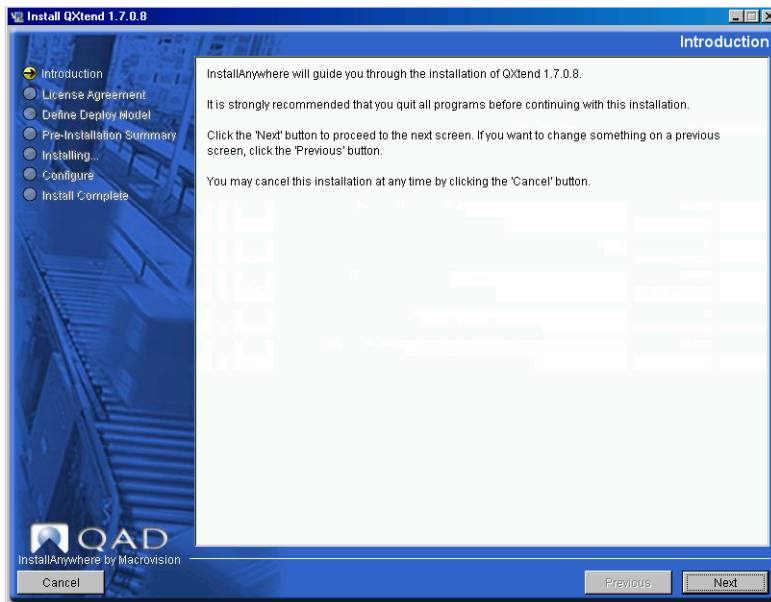

- 4 Click Next. The License Agreement screen displays.
- 5 Scroll to the end of the license agreement.
- 6 Select the “I accept the terms of the License Agreement” option, then click Next.

**Note** The option to accept the license agreement is enabled only when you scroll to the bottom of the agreement.

The Log File Directory screen displays.

- 7 Accept the default location for the install log files (C:\instlog), or enter a different path.
- 8 Click Next. The QAD Deployment Configuration Service screen displays.

## Specify Deployment Configuration Parameters

For details about the QDCS, see “QAD Deployment Configuration Service” on page 4.

**Fig. 4.4**  
Specify Deployment Configuration Parameters

Deployment Configuration Parameters

Network Service     Local Service

Local Host Name

Tomcat Host

Tomcat Port

Tomcat Admin User\*

Admin Password\*

Local File

\*Only required if deploying a new service

Advanced

*Network Service.* Select this option to use a QDCS located on your network.

**Note** Tomcat must be installed and running to use Network Service. If you have an existing deployment service, you must create a new service because the version changed in the QXtend 1.6.2 release.

*Local Service.* Select this option to use a QDCS file located on your local machine. Selecting this option disables all fields except Local File.

*Local Host Name.* This displays the name of the current machine (read-only).

*Tomcat Host.* Enter the Tomcat server name (for Network Service only).

*Tomcat Port.* Enter the Tomcat port number (for Network Service only).

*Tomcat Admin User.* Enter the user name for the Tomcat manager role (for Network Service only).

*Admin Password.* Enter the password of the user with the manager role (for Network Service only).

*Local File.* Enter the file name on the local machine containing the parameter settings (for Local Service only).

*Advanced.* Click this button to display a dialog box that allows you to specify the name of a new QDCS.

- 9 A pop-up window may display that says a QAD Deployment Configuration Service (QDCS) was not detected on a host. This means the QDCS is not deployed on the Tomcat server just specified or the wrong server was specified. Click Yes if you want the installer to deploy the QDCS.
- 10 Click Next. The Environment Selection screen displays.

## Select Environment

- 11 In the Select an Environment panel, specify the environment to use. To create a new environment, click Create New and enter the name of the environment you want to create.

**Fig. 4.5**  
Select an Environment



- 12 Click Next. The Select an Installation Option screen displays.

## Specify Install, Upgrade, or Migrate

**Fig. 4.6**  
Specify Install, Upgrade, or Migrate



To perform an installation, verify Install is selected, click Next, and continue to “Installing QXtend” on page 26.

To upgrade components of an existing QXtend installation to the current QXtend release, select Upgrade, click Next, and go to “Upgrading QXtend” on page 37.

To migrate the existing application data from a previous QXtend installation to the current QXtend release, select Migrate, click Next, and see “Migrating QXtend” on page 40.

**Note** You must have completed a successful installation before attempting to upgrade the QXI servlet, QXO database, or QXO events database components.

## Installing QXtend

### QXtend Installation Settings

QXtend installation involves the automatic or manual population of fields on one or more screens. During installation, hovering over a field label displays the corresponding parameter name. Likewise, hovering over the field displays the fully resolved parameter as a tool tip. For more information on dynamic parameter referencing, see “Tokens” on page 66.

**Fig. 4.7**  
QXtend Installation Settings

- 1 Enter the necessary information in the QXtend Typical Installation (Single Host) screen:
  - Host.* Enter the name of the host where the QAD Enterprise Edition qaddb is installed.
  - Destination Directory.* Enter the directory where the QXtend adapter is located.
  - Install .NET UI Plugin.* Select this check box if you want to install the .NET UI plug-in.
  - Version.* Select the .NET UI version from the drop-down list.
  - Use OpenEdge DBMAN.* Select this check box to use DBMAN to manage the QXO and qxevent databases. This box is enabled only if you specify an MFGPro version of QAD EE 2011.1 or later.
  - Update Conmgr Properties.* Select this check box to update the `$DLC/properties/conmgr.properties` file using the installer. Not selecting this box allows you to update the file manually. This box is only enabled if Use OpenEdge DBMAN is selected.
  - Default Configuration.* Select this check box to load QXtend with an initial set of default configuration parameters. See Appendix B, “Default Configuration,” on page 73 for more information.

*O/S Username.* The user name for the operating system of the destination host.

*O/S Password.* The password for the operating system of the destination host.

*Windows O/S.* Select this box if the destination host is Windows.

*O/S Domain.* The name of the domain to which the destination host belongs. This is only enabled if the destination host operating system is Windows.

## 2 QXtend provides two installation methods: Typical and Advanced.

Typical Installation is a simplified install process that automatically fills the QXtend installer fields with parameters for a default QXtend installation. For detailed information regarding default installation parameters, see Appendix A, “Typical Installation Parameters,” on page 65.

Advanced Installation allows you to individually enter the parameters to create a custom QXtend configuration. You are also able to add additional QXtend adapters and QXO Events Databases according to the number of QAD Enterprise Application installations. Finally, if you want to modify any of the default configuration parameters, use QXtend’s advanced installation mode.

To continue with a typical installation, click Next and go to “Review the Pre-installation Summary” on page 43.

To perform a custom installation, click Advanced and go to “Advanced Installation” on page 27.

## Advanced Installation

### Select the Host and Modules to Install

**Fig. 4.8**

Choose the Host and Install Set

The screenshot displays the QXtend installer interface. The top section, titled 'Host Selection', features a dropdown menu with 'vmwin2003' selected, and three buttons: 'Add', 'Rename', and 'Delete'. Below this is the 'Module Selection' section, which contains a list of modules to install, each with a checked checkbox: QXI Servlet, QXtend Adapter, QXO Servlet, QXO Events Database, QXO Database, QXO Server, and QXtend QAD .Net UI Plugin. At the bottom of the module list are three buttons: 'Select All', 'De-Select All', and 'Modify Status'.

- 1 Enter the host on which to install the components in the Host Selection panel.
- 2 Use the Add and Delete buttons to create and delete hosts as required.

- 3 In the Module Selection panel, select the components to install on the specified host.

**Note** To install QXI only, select the QXI servlet and adapter code components. To install QXO only, select all of the QXO components and the adapter code component.

**Note** Under each environment (“QDCS Information Hierarchy” on page 5 and “Select Environment” on page 25) you can select each component once across all hosts that make up the configuration with the exception of the QXtend Adapter and QXO Events Database. This allows you to configure against multiple QAD Enterprise Applications installations.

- 4 Click Next to display the Module Copy Selection screen.

**Fig. 4.9**  
Module Copy Selection

The component list on the left shows the components available for installation. The Status column to the right indicates the installation status for each component. The first time the installer is run, the Status column is blank. After an installation, the Status column shows Incomplete—indicating the component was not installed successfully—or Complete, indicating the component was installed successfully.

- 5 For each selected component, do the following as required:

- a Create, rename, or delete instances.

**Note** New instances are enabled only for the QXtend Adapter and QXO Events database. This allows you to configure against multiple QAD Enterprise Applications installations.

- b Assign the required components to an instance. Select the check box for a component if the instance it should be included in is highlighted.

- c For each selected component for that instance, enter all of the required parameter settings as described in the following sections.

You cannot select a different component until you have entered all of the required information for the currently selected component.

**Note** You must provide information in the fields highlighted in orange.

### Configure the QXI Servlet

- 6** In the Inbound Web Application panel, enter the name of the application as it is known by the Tomcat application server.

- 7** In the Tomcat for Inbound panel, complete the required fields.

*Port.* Enter the Tomcat port.

*Home Directory.* Enter the location of the home directory where Tomcat is installed.

*Admin Name.* Enter the user name for the Tomcat manager role.

*Admin Password.* Enter the password of the user with the manager role.

- 8** In the Migrate Inbound Configuration panel, make the necessary selections and complete the field.

*Enable.* Select the check box to enable migration of QXI servlet configuration data from a previously installed QXI servlet.

*WebApp Name.* Enter the name of the application as it is known by the Tomcat application server.

*Tomcat Directory.* Enter the location of the home directory where Tomcat is installed.

*Version.* Select the version being migrated from the drop-down list.

- 9** If necessary, select the next component to configure from the Modules to Install panel. Otherwise, go to step 36 on page 36.

### Configure the QXtend Adapter

- 10** Complete the required fields in the MFG/PRO panel.

*Version.* Select the QAD Enterprise Applications version from the drop-down list that the adapter is being installed against.

*Service Pack.* Enter the number of the service pack in use.

*Home Directory.* Enter the home directory where the QXtend adapter is installed.

*ProPath.* If not populated automatically, enter the MFG/PRO source code directory (`xrc` directory) to use during QXtend Adapter compilation.

*Database Type.* Select Progress or Other. Choose Other to install QXtend against a QAD Enterprise Application running on Oracle or other non-Progress database.

*Database Language.* Enter the codepage language (for example, utf).

*Internal Codepage.* Enter the name of the codepage used in memory.

*Stream Codepage.* Enter the name of the codepage used for stream I/O.

*Use Alternate DB Set.* Enable this to specify non-standard empty QAD databases. If this is unchecked, skip steps 11 and 12 because the MFG/PRO Database and MFG/PRO Admin Database panels are disabled.

*Empty DB Directory.* If not populated automatically, enter the directory where the QXtend adapter empty databases are located.

*Empty DB.* Enter the name of the empty QXtend adapter database.

*Admin Empty DB.* Enter the name of the empty QXtend adapter admin database.

*Additional Connections Params.* Enter any extra parameters required to compile the QXtend adapter.

*Dataserver Connection Params.* Used if the database type is Other. Specify the parameters to use to connect to the database through Progress.

*Progress Directory.* Enter the location of Progress that this instance of the QXtend adapter uses. This should be the same version of Progress as the QAD Enterprise Application.

*QDT Directory.* Enter the location of the QDT. This is currently only applicable if installing against QAD Enterprise Edition.

*Environment Name.* Enter the configuration name that was specified in QDT.

*Financial AppServer.* Enter the name of the AppServer for Financials. This is currently only applicable if installing against QAD Enterprise Edition.

*Financial NameServer Port.* Enter the NameServer port that the Financials AppServer uses. This is currently only applicable if installing against QAD Enterprise Edition.

*.NET UI Home Directory.* Enter the location of the .NET UI Progress code.

**11** In the MFG/PRO Database panel, complete the required fields.

*Physical Name.* Enter the physical name of the qaddb for QAD Enterprise Applications.

*Connection Type.* Select Local or Network.

*Multi-user.* Select this option if your database is operating in multi-user mode. Using this option means that you may not have to shut down your database before installing QAD QXtend. However, QAD recommends that you shut down your qxevents database.

*Database Directory.* This is the database where the QAD Enterprise Edition qaddb database is installed. Enter the directory if the connection type is Local.

*Host.* Enter the name of the host where the QAD Enterprise Edition qaddb is installed.

*Service Name.* Enter the network service used by the QAD Enterprise Edition qaddb.

**12** Complete the required fields in the MFG/PRO Admin Database panel.

*Physical Name.* Enter the physical name of the QAD Enterprise Edition admin database.

*Connection Type.* Select Local or Network.

*Multi-user.* Select this option to indicate that your database is operating in multi-user mode. If you use this option, the database must be running during QXtend installation. If you do not use this option, the database must be shut down before installing QXtend.

*Database Directory.* Enter the name of the database directory where the QAD Enterprise Edition admin database is installed.

*Host.* Enter the name of the host where the QAD Enterprise Edition admin database is installed.

*Service Name.* Enter the network service used by the QAD Enterprise Edition admin database.

- 13** Complete the required fields in the QXtend Adapter panel.

*Destination Directory.* Enter the directory where the QXtend adapter is located.

*Client Startup Params.* Enter the client startup parameters required for starting a character session in your QAD Enterprise Application.

- 14** In the Adapter Native API AppServer panel, complete the required fields.

**Note** This is only applicable to eB2.1 SP4 and later.

*AppServer Name.* Enter the name of the AppServer for using Native APIs.

*AppServer Port.* Enter the AppServer port number.

*AppServer Max Connections.* Enter the maximum number of connections to the AppServer.

*Name Server.* Enter the NameServer name to which the AppServer will belong.

*Name Server Port.* Enter the NameServer port that the AppServer will use.

*AdminServer Port.* Enter the AdminServer port that the AppServer will use.

*Update Ubroker Properties.* Select this check box for the installer to update the Ubroker Properties. Make sure the installer has the permissions required to update the file. If you do not select the check box, you can create the entry manually. You can find the template under the properties subdirectory of the QXO Adapter directory.

- 15** If necessary, select the next component to configure from the Modules to Install panel. Otherwise, go to step 36 on page 36.

### Configure the QXO Servlet

- 16** In the Outbound Web Application panel, complete the required fields.

*WebApp Name.* Enter the name of the QXO servlet application as known by the Tomcat application server.

*AppServer Name.* Enter the Progress AppServer name.

*AppServer Host.* Enter the name of the host on which the AppServer is located.

*Name Server Port.* Enter the Progress NameServer port number.

- 17** In the Tomcat for Outbound panel, complete the required fields. These values should be populated automatically if QXO will use the same AppServer configuration.

*Port.* Enter the Tomcat port number.

*Home Directory.* Enter the location of the home directory where Tomcat is installed.

*Admin Name.* Enter the user name for the Tomcat manager role.

*Admin Password.* Enter the password of the user with the manager role.

- 18** If necessary, select the next component to configure from the Modules to Install panel. Otherwise, go to step 36 on page 36.

### Configure the QXO Events Database

- 19** Complete the required fields in the MFG/PRO version panel.

*Version.* Enter the version of the QAD Enterprise Application the adapter is being installed against.

*Service Pack.* Enter the number of the service pack in use.

*Database Type.* Select Progress or Other. Choose Other to install QXtend against a QAD Enterprise Application running on Oracle or another non-Progress database.

*Database Language.* Enter the codepage language (for example, utf).

- 20** In the MFG/PRO Database panel, complete the required fields.

*Physical Name.* Enter the physical name of the qadddb for QAD Enterprise Applications.

*Connection Type.* Select Local or Network.

*Multi-user.* Select this option if your database is operating in multi-user mode. Using this option means that you may not have to shut down your database before installing QAD QXtend. However, QAD recommends that you shut down your qxevents database.

*Database Directory.* This is the database where the QAD Enterprise Edition admin database is installed. Enter the directory if the connection type is Local.

*Host.* Enter the name of the host where the QAD Enterprise Edition database is installed.

*Service Name.* Enter the network service used by the QAD Enterprise Edition admin database.

- 21** In the MFG/PRO Admin Database panel, complete the required fields.

*Physical Name.* Enter the physical name of the QAD Enterprise Edition admin database.

*Connection Type.* Select Local or Network.

*Multi-user.* Select this option if your database is operating in multi-user mode.

If you use this option, the database must be running during QXtend installation. If you do not use this option, you must shut down the database before installing QXtend.

*Database Directory.* Enter the name of the database directory where the QAD Enterprise Edition admin database is installed.

*Host.* Enter the name of the host where the QAD Enterprise Edition admin database is installed.

*Service Name.* Enter the network service used by the QAD Enterprise Edition admin database.

- 22** In the QXEvents Database panel, complete the required fields.

*Physical Name.* Enter the qxevents database physical name.

*Database Directory.* Enter the qxevents database directory.

*Connect Using Client/Server.* Select this check box to use client/server mode to connect to the database.

*Host.* Enter the name of the host where the qxevents database is installed.

*Service Name.* The installer enters this into the services file. Otherwise, enter the name of the network service used by this database.

*Create Services File Entry.* Select this check box to enable the Service Port field and to have the port information added to the service.

*Service Port.* Entered into the services file by the installer. Otherwise, enter the number of the port used by this network service.

*MFG DB Start Script.* Enter the location of the script that starts the QAD Enterprise application databases.

*MFG DB Conn.pf.* Enter the connection parameter file used by the client session.

*Block Size.* Enter the block size to use for the qxevents database. This is dependent on the operating system block size.

*Progress Directory.* Enter the Progress location used by the Progress AppServer.

- 23** If you are migrating an existing qxevents database to the new install, complete the following required fields in the QXEvents Migrate Configuration panel (see “Upgrading QXtend” on page 37 for more details). These fields may already be populated.

*Enable.* Select the check box to enable migration of qxevents configuration data from a previously installed qxevents database.

*Physical Name.* Enter the physical name of the source qxevents database.

*Connection Type.* Enter the connection type to use to connect to the source qxevents database.

*Multi-user.* If the source QXEvents Connection Type is Local, specify whether or not to connect in multi-user mode.

If you use this option, the database must be running during QXtend installation. If you do not use this option, you must shut down the database before installing QXtend.

*Database Directory.* Enter the source qxevents database directory. This only applies when the Connection Type is Local.

*Host.* Enter the name of the host where the source qxevents database is installed.

*Service Name.* If the Connection Type is Network, specify the ServiceName or service port number to use.

*Version.* Select the version being migrated.

- 24** If necessary, select the next component to configure from the Modules to Install panel. Otherwise, go to step 36 on page 36.

## Configure the QXO Database

- 25** Complete the required fields in the Outbound Database panel.

*Physical Name.* Enter the physical name of the QXO database.

*Database Directory.* Enter the QXO database location.

*Service Name.* The installer enters this into the services file. Otherwise, enter the name of the network service for this database.

*Create Services File Entry.* Select this check box to enable the Service Port field and to have the port information added to the service.

*Service Port.* The installer enters this into the services file. Otherwise, enter the port number for the network service.

*Block Size.* Enter the QXO database block size.

*Progress Directory.* Enter the location of the Progress directory used by this database.

*Advanced Database Config.* Selecting this box displays additional fields for specifying the locations of the schema areas for the QXO database. Placing these areas on different disks can improve performance.

Selecting this box displays the following fields:

*Before Image.* This is the location of the BI file.

*Schema Area.* There are no tables in this area.

*Configuration Data.* This is a low-volume, low-capacity area.

*Configuration Indexes.* This is a low-volume, low-capacity area.

*Transactional Data.* This is a high-volume, medium-capacity area.

*Transactional Indexes.* This is a high-volume, medium-capacity area.

*Raw Msgs (CLOB).* This is a high-volume, high-capacity area.

*Subscriber Msgs (CLOB).* This is a high-volume, high-capacity area.

- 26** In the Migrate QXODB Configuration panel, complete the required fields.

*Enable.* Select the check box to enable migration of QXO database configuration data from a previously installed QXO database.

*Physical Name.* Enter the physical name of the source QXODB database.

*Connection Type.* Enter the connection type to use to connect to the source QXODB database.

*Multi-user.* If the source QXODB Connection Type is Local, specify whether to connect in multi-user mode.

If you use this option, the database must be running when installing QXtend. If you do not use this option, the database must be shut down before installing QXtend.

*Database Directory.* Enter the directory for the source QXODB database. This only applies when the Connection Type is Local.

*Host.* Enter the name of the host where the source QXODB database is installed.

*Service Name.* If Connection Type is Network, specify the service name or service port number to use.

*Version.* Select the version being migrated from the drop-down list.

- 27** If necessary, select the next component to configure from the Modules to Install panel. Otherwise, go to step 36 on page 36.

### Configure the QXO Server

- 28** Complete the required fields in the Outbound Server panel.

*Destination Directory.* Enter the directory containing the qxo server.

*Outbound Database Name.* Enter the Outbound database name.

*Connect Using Client/Server.* Select this check box to use client/server mode when connecting to the database.

*Outbound Database Directory.* Enter the Outbound database directory location.

*Outbound Database Host.* Enter the Outbound database host name.

*Outbound Database Service.* Enter the name of the service for the Outbound database.

*Progress Directory.* Enter the Progress location used by the Progress AppServer.

- 29** Complete the required fields in the Outbound UI AppServer panel.

*AppServer Name.* Enter the Progress AppServer name.

*AppServer Port.* Enter the Progress AppServer port number.

*AppServer Max Connections.* Enter the maximum number of connections allowed by this AppServer.

*AdminServer Port.* Enter the port number of the Progress AdminServer.

*Name Server.* Enter the name of the NameServer.

*Update Ubroker Properties.* Select this check box for the installer to update the Ubroker Properties. Make sure the installer has the permissions required to update the file. If you do not select the check box, you must create the entry manually. The template is located under the scripts subdirectory of the QXO Server directory. The Outbound UI and Outbound SI AppServers are both required for correct QXO operation.

- 30** In the Outbound SI AppServer panel, complete the required fields.

*AppServer Name.* Enter the name of the Progress AppServer.

*AppServer Port.* Enter the port number of the Progress AppServer.

*AppServer Max Connections.* Enter the maximum number of connections allowed by this AppServer.

*Admin Server Port.* Enter the port number of the Progress AdminServer.

*Name Server.* Enter the name of the NameServer.

*Update Ubroker Properties.* Select this check box for the installer to update the Ubroker Properties. Make sure the installer has the permissions required to update the file. If you do not select the check box, you must create the entry manually. The template is located under the scripts subdirectory of the QXO Server directory. The Outbound UI and Outbound SI AppServers are both required for correct QXO operation.

- 31** If necessary, select the next component to configure from the Modules to Install panel. Otherwise, go to step 36 on page 36.

### Configure the QXtend QAD .NET UI Plug-in

- 32** Complete the required fields in the .NET UI Server panel.

*Version.* Enter the QAD .NET UI version.

*WebApp Name.* Enter the name of the qad home server.

*Port.* Enter the Tomcat Port.

*Tomcat Home.* Enter the Tomcat installation home directory.

*Configuration Name.* Enter the configuration name set for the .NET UI (the default is qadui).

- 33** In the Outbound UI AppServer Setting panel, complete the required fields.

*Direct Connect.* Choose whether the plug-in is to connect in Direct Connect mode or via a NameServer.

*AppServer Name.* Enter the name of the QXO AppServer.

*AppServer Host.* Enter the host of the QXO AppServer.

*Name Server Port.* Enter the port of the NameServer (if Direct Connect is not selected).

*AppServer Port.* Enter the port of the AppServer (if Direct Connect is selected).

- 34** Complete the required fields in the Include QXtend Menu Entries panel.

*Include Inbound.* Choose whether to add Inbound to the menu.

*Include Outbound.* Choose whether to add Outbound to the menu

- 35** If you have entered all of the parameter settings for the required components, click Next and go to Default Configuration. See Appendix B, “Default Configuration,” on page 73 for more information.

- 36** Click Next and go to “Review the Pre-installation Summary” on page 43.

## Upgrading QXtend

### Select the Host and Modules to Upgrade

**Fig. 4.10**  
Choose the Host and Install Set

The screenshot shows a software interface for selecting upgrade options. It is divided into two main sections: 'Host Selection' and 'Module Selection'.  
 In the 'Host Selection' section, there is a text input field containing 'vmwin2003', followed by three buttons: 'Add', 'Rename', and 'Delete'.  
 In the 'Module Selection' section, there is a list of modules under the heading 'Modules to upgrade'. Each item has a checkbox:  
 - QXI Servlet:   
 - QXtend Adapter:   
 - QXO Servlet:   
 - QXO Events Database:   
 - QXO Database:   
 - QXO Server:   
 - QXtend QAD .Net UI Plugin:   
 At the bottom of the 'Module Selection' section, there are three buttons: 'Select All', 'De-Select All', and 'Modify Status'.

- 1 In the Host Selection panel, enter the host on which to upgrade the components.
- 2 Use the Add and Delete buttons to create and delete hosts as required.
- 3 The components available for upgrade consist of code components (QXtend Adapter, QXO Servlet, QXO Server, and .NET UI Plug-in) and configuration components (QXI Servlet, QXO Event Database, and QXO Database). The configuration components have system information and application data that must be transferred to the new QXtend instance. If you do not want to transfer the existing data of a configuration component, use install instead of upgrade.

In the Module Selection panel, select the components to upgrade on the specified host. Upgrading a code component installs a new instance of the component in the same location after backup of the contents to the `<target>/backup` directory.

- 4 Click Next to display the Module Copy Selection panel.

**Fig. 4.11**  
Module Copy Selection

The screenshot shows two panels from the QAD QXtend installer. The top panel, titled 'Host Selection', has a dropdown menu for 'Host' set to 'qadrh'. Below it is a table with two columns: 'Name' and 'Status'. The table is split into two panes. The left pane lists components available for upgrade: QXI Servlet, QXtend Adapter, QXO Servlet, QXO Events Database, QXO Database, QXO Server, and QXtend QAD .Net U... The right pane shows a component named 'demo' with a blank status field. Below the table are 'Create', 'Delete', and 'Rename' buttons. The bottom panel, titled 'Convert Inbound', contains several input fields: 'WebApp Name' (qxi), 'Tomcat Directory' (/dr01/tomcat/8080), 'Version' (1.2), 'Port' (@GLOBAL\_TOMCAT\_PORT@), 'Admin Name' (admin), and 'Admin Password' (masked with dots).

The component list on the left shows the components available for upgrade. The Status column on the right indicates the installation status of each component. The first time the installer is run, the Status column is blank. After an installation, the Status column shows Incomplete, indicating the component was not installed successfully, or Complete, indicating the component was installed successfully.

- For each selected component for that instance, enter all of the required parameter settings, as described in the following sections.

**Note**

- Multiple instances are enabled only for the QXO Events Database and QXtend Adapter. The target QXODB and target QXEvents databases must be shut down before upgrading.
- You cannot select a different component until you have entered all of the required configuration information for the currently selected component. You must provide information for the fields highlighted in orange.

- Click Next when you have entered all parameter settings for the required components.

### Configure the QXI Servlet

- Complete the required fields in the Convert Inbound panel.

*WebApp Name.* Enter the name of the application as it is known by the Tomcat application server.

*Tomcat Directory.* Enter the location of the home directory where Tomcat is installed.

*Version.* Enter the version being migrated from the drop-down list.

*Port.* Enter the Tomcat port.

*Admin Name.* Enter the user name for the Tomcat manager role.

*Admin Password.* Enter the password of the user with the manager role.

**Note** During QXI conversion, a prompt requests that Tomcat be shut down. This is done to replace the old servlet with the new one. Shut down Tomcat. Once it has shut down, click Ok. The installer replaces the servlet. When this process finishes, a second prompt asks you to restart Tomcat.

**Important** You must perform shutdown/startup before pressing the button.

- 8 If necessary, select the next component to configure.

### Configure the QXtend Adapter

- 9 See steps 10 to 12 of “Configure the QXtend Adapter” on page 29 in the Installation section of this guide.

- 10 If necessary, select the next component to configure.

**Note** If the destination directory contains files, they are moved to `<destination directory>/<backup>`. The timestamp of each backed up file is used in the file name.

### Configure the QXO Servlet

- 11 See steps 14 and 15 of “Configure the QXO Servlet” on page 31 in the Installation section of this guide.

- 12 If necessary, select the next component to configure.

**Note** If the WebApp directory exists, it is backed up to `<tomcat directory>/<backups>`. The timestamp of each backed-up file is used in the file name.

### Configure the QXO Events Database

- 13 In the Convert QXevents panel, complete the required fields.

*Physical Name.* Enter the physical name of the qxevents database.

*Database Directory.* Enter the location of the database directory where the source qxevents database is installed.

*Version.* Select the version being converted in the drop-down list.

*Progress Directory.* Enter the location of Progress used by this qxevents instance. This should be the same Progress version as the QAD Enterprise Application databases.

- 14 If necessary, select the next component to configure.

### Configure the QXO Database

- 15 In the Convert QXODB panel, complete the required fields.

*Physical Name.* Enter the physical name of the QXO database.

*Database Directory.* Enter the location of the database directory where the source QXO database is installed.

*Version.* Select the version being converted in the drop-down list.

*Progress Directory.* Enter the location of Progress used by this instance of QXODB.

### Configure the QXO Server

**16** See steps 26 to 28 of “Configure the QXO Server” on page 35 in the Installation section of this manual.

**17** If necessary, select the next component to configure.

**Note** If the destination directory contains files, they are moved to *<destination directory>/<backup>*. The time stamp of each backed-up file is used in the file name.

### Configure the QXtend QAD .NET UI Plug-in

**18** See steps 30 to 33 under “Configure the QXtend QAD .NET UI Plug-in” on page 36 in the Installation section of this manual.

**19** If you have entered all parameter settings for the required components, click Next and go to “Review the Pre-installation Summary” on page 43.

## Migrating QXtend

### Select the Host and Modules to Upgrade

**Fig. 4.12**  
Choose Host and Install Set

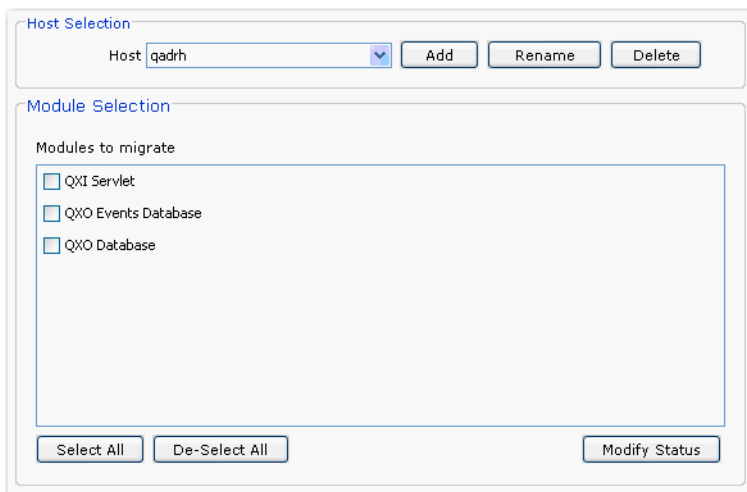

- 1** In the Host Selection panel, enter the host on which to install the components.
- 2** Use the Add and Delete buttons to create and delete hosts as required.
- 3** In the Module Selection panel, select the components to migrate on the specified host.

- 4 Click Next to display the Module Copy Selection screen.

**Fig. 4.13**  
Module Copy Selection

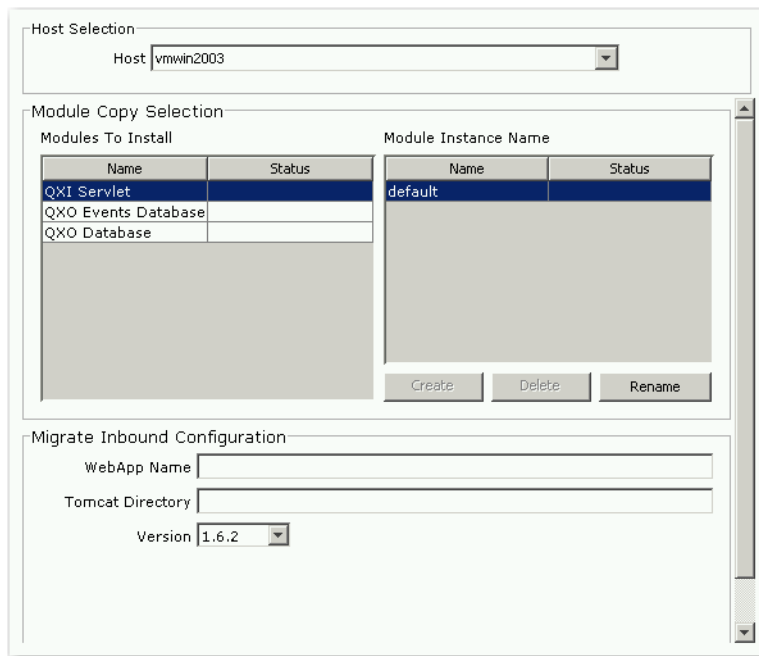

The component list on the left shows the components available for installation. The Status column to the right indicates the installation status of each component. The first time the installer is run, the Status column is blank. After a migration, the Status column shows Incomplete, indicating the component was not migrated successfully, or Complete, indicating the component was migrated successfully.

- 5 For each selected component, do the following as required:

- a Create, rename, or delete instances.

**Note**

- New instances are enabled only for the QXO Events database.
- If you select QXO Database, a warning appears that says “PLEASE NOTE: The destination QXODB will lose any existing configuration.”

- b Assign the required components to an instance. Select the check box for a component when the instance in which it should be included is highlighted.

- c For each selected component for that instance, enter all of the required parameter settings as described in the following sections.

**Note** You cannot select a different component until you have entered all of the required configuration information for the currently selected component. The required fields are highlighted in orange.

### Configure the QXI Servlet

- 6 In the Migrate Inbound Configuration panel, complete the required fields.

*WebApp Name.* Enter the name of the application as it is known by the Tomcat application server.

*Tomcat Directory.* Enter the location of the home directory where Tomcat is installed.

*Version.* Select the version being migrated from the drop-down list.

- 7 If necessary, select the next component to configure.

### Configure the QXO Events Database

- 8 In the Migrate QXEvents Configuration panel, complete the required fields.

*Physical Name.* Enter the physical name of the qxevents database.

*Connection type.* Select Local or Network.

*Multi-User.* Select this option if your database is operating in multi-user mode. If you use this option, you may not have to shut down your database before you install QAD QXtend. However, QAD recommends that you shut down your qxevents database.

*Database Directory.* Enter the location of the database directory where the source qxevents database is installed.

*Host.* Enter the name of the host where the QAD Enterprise Applications database is installed.

*Service Name.* Enter the network service used by the QAD Enterprise Applications database.

*Version.* Select the version being migrated from the drop-down list.

- 9 If necessary, select the next component to configure.

### Configure the QXO Database

- 10 In the Migrate QXODB Configuration panel, complete the required fields.

*Physical Name.* Enter the physical name of the QXO database

*Connection Type.* Select Local or Network.

*Multi-user.* Select this option if your database is operating in multi-user mode. If you use this option, you may not have to shut down your database before you install QAD QXtend. However, QAD recommends that you shut down your qxevents database.

*Database Directory.* Enter the location of the database directory where the source QXO database is installed.

*Host.* Enter the name of the host on which the QAD Enterprise Applications database is installed.

*Service Name.* Enter the network service used by the QAD Enterprise Applications database.

*Version.* Use the drop-down list to select the version being migrated.

- 11 If you have entered all parameter settings for the required components, click Next and go to “Review the Pre-installation Summary” on page 43.

## Review the Pre-installation Summary

The Pre-installation Summary screen displays the components selected for install and disk space information.

**Note** If no components were selected for installation on the current host, a message appears. Move to each host that is part of the installation and point to the configuration you have just created.

**Fig. 4.14**  
Pre-installation Summary

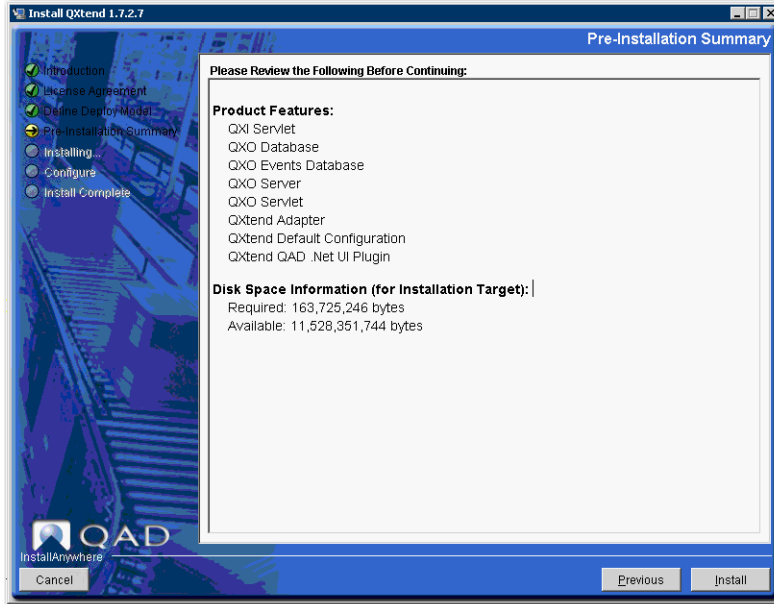

Review the information and click Install to continue with the installation, upgrade, or migration.

**Note** If the installer encounters an error, it pauses, allowing you to correct the problem. See Appendix C, “Process Control,” on page 77 for more information. If you have difficulty resolving a problem, see Chapter 6, “Troubleshooting QAD QXtend Installs, Upgrades, and Migrations,” on page 57.

When the install, upgrade, or migration finishes, proceed to “Review the Installation Summary” on page 44.

## Review the Installation Summary

**Fig. 4.15**  
Install Status Screen

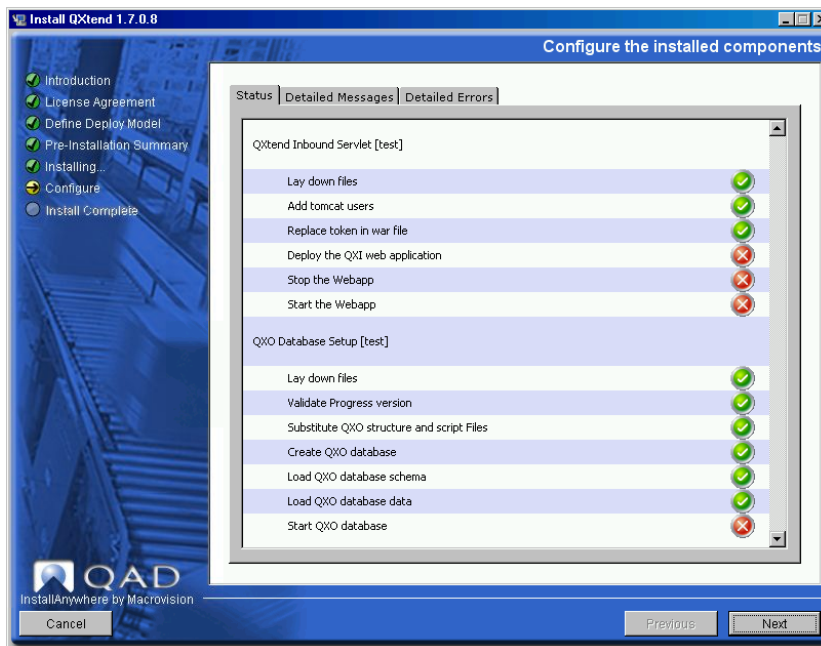

- 1 Use the Status screen to review the results of the install, upgrade, or migration.
- 2 A red cross symbol indicates that an error occurred. If one or more red crosses are displayed, see Chapter 6, “Troubleshooting QAD QXtend Installs, Upgrades, and Migrations,” on page 57.

If only green check marks or green check marks and one or more blue double arrows are displayed, the install, upgrade, or migration was successful. Click Next.

- 3 The Install Complete screen appears.

Depending on your previous selections, the installer may display a reminder that describes post-installation work you must perform. Note the information for further reference.

When you are finished, press Done.

To finalize an installation, see “Post-installation” on page 48. To complete an upgrade, see “Post-upgrade” on page 55. To finalize a migration, see “Post-migration” on page 56.

## Installing, Upgrading, and Migrating QAD QXtend in a Character Environment

The following procedure describes how to install, upgrade, and migrate QAD QXtend in a character environment. It assumes that you are using Windows.

- 1 Verify that Tomcat is running.
- 2 Verify that you have the permissions needed to access the relevant folders.

- 3 Run the GUI installer to populate the QDCS with the required parameter settings.
- 4 Specify an environment and host, select the components to install or upgrade, and specify the required parameters.  
**Note** For information about the QDCS see “QAD Deployment Configuration Service” on page 4.
- 5 Move to the host you created in step 4.
- 6 Mount the release media.
- 7 Choose Start|All Programs|Accessories|Command Prompt to open a command window.
- 8 Navigate to the `InstData` directory on the release media.
- 9 Navigate to the appropriate directory for your environment. For example, if you are in a Linux environment, navigate to the Linux directory.
- 10 Navigate to the `VM` directory.
- 11 Start the executable by entering one of the following commands:
  - On Windows: `QXtend.exe -i console`
  - On AIX, Linux, or HP-UX: `sh ./QXtend.bin -i console`
- 12 The Introduction displays. Press Enter to continue. The first page of the License Agreement text displays.
- 13 Press Enter to move through and read the pages.
- 14 On the final page of the License Agreement, press Y to accept the terms, and then press Enter. The Log File Directory text displays.
- 15 Press Enter to accept the default location of the log file directory, or enter a different directory.
- 16 Select the Parameter Service type. Enter Y for network (the default) or N for local file.
- 17 Get User Input displays. These settings permit the use of the settings you defined using the QDCS in the GUI installer.
- 18 Enter the following:
  - Tomcat host name
  - Tomcat port number
  - WebApp name
  - Local parameter settings file name
  - Environment name**Note** All of the above entries are case-sensitive.
- 19 Select install, upgrade, or migration.
- 20 The list of components being installed or upgraded displays. Review the list and press Enter to continue.  
The installation or upgrade begins using the parameter settings stored in the QDCS.

21 The Install Complete screen appears.

**Note** If the installer encounter an error, it pauses, allowing you to correct the problem. See Appendix C, “Process Control,” on page 77 for more information. If you have difficulty resolving a problem, see Chapter 6, “Troubleshooting QAD QXtend Installs, Upgrades, and Migrations,” on page 57.

22 After reviewing the results of the install, upgrade, or migration, press Enter.

23 Restart the Tomcat AppServer and start QAD Enterprise Applications.

## Adding Additional QAD Enterprise Application Instances to QXtend

To install additional source applications (except a DDP-only installation) for Outbound, you must install the QXO Events Database and QXtend Adapter as another instance on the same or a new host from the configured environment. To add additional receivers for Inbound, you must install the QXtend Adapter as another instance on the same or a new host from the configured environment.

To use a QAD ERP core product as the source application and receiver, you must install the QXO Events Database and QXtend Adapter.

To do this, see the advanced installation information in “QXtend Installation Settings” on page 26.

# Post-installation, Post-upgrade, and Post-migration Tasks

This section describes post-installation and post-upgrade tasks. This section also contains information about post-migration.

***Post-installation* 48**

***Post-upgrade* 55**

***Post-migration* 56**

## Post-installation

The following procedures are specific to QXO or QXI as indicated:

- Recompile the AppShell programs (required for eB2.1 SP4 to SP6 only)
- Ensure that the Java components are installed correctly (QXI)
- Use QDoc requestors instead of user IDs (QXI)
- Enable the Secure Socket Layer (QXI)
- Verify the QXO server installation (QXO)
- Verify the QXO server and source application communication (QXO)
- Verify the PROPATH and event recording (QXO)
- Verify QXO messages (QXO)

## Logging In

To determine if the Java components of the QXI component are correctly installed, do the following:

- 1 If you are not going from eB2.1 SP4 to SP6, go to step 2.  
If you are going from eB2.1 SP4 to SP6, you must recompile the AppShell programs with the QXtend Adapter in the PROPATH before the standard QAD Applications code. This is necessary because the AppShell uses an include file patched as part of the QXtend adapter.
- 2 Start Tomcat if it is not already running.
- 3 Launch a browser on your client machine.
- 4 Navigate to the following URL:  
`http://<qxtendhost>:8080/<QXI webapp>/index.jsp`  
The login screen displays.
- 5 Enter the admin user and password defined previously. Choose OK.  
The screen shown in Figure 5.1 displays.

**Fig. 5.1**  
QXI Main Screen

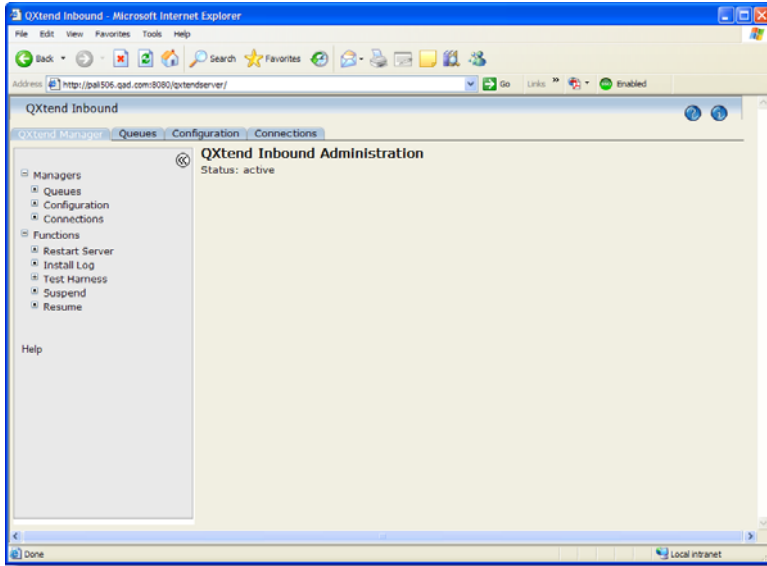

## Enable SSL

QAD QXtend supports SSL to encrypt all HTTP messages between the client and server. To satisfy this requirement, correctly configure Tomcat to provide an SSL connection to the QAD QXtend server WebApp.

To complete the configuration, you must:

- Modify `server.xml`.
- Modify `catalina.bat` or `catalina.sh`.
- Create Trusted Security Certificates in Java.

## Modify `server.xml`

Define an SSL HTTP/1.1 connector on port 8443 in `TOMCAT_HOME\conf\server.xml`. The first section of the file content below appears in the default `server.xml`. Add the Connector definition following the end of the comment marker (`-->`) as shown below.

```
<!-- Define a SSL HTTP/1.1 Connector on port 8443 -->
<!--
<Connector port="8443" maxHttpHeaderSize="8192"
  maxThreads="150" minSpareThreads="25" maxSpareThreads="75"
  enableLookups="false" disableUploadTimeout="true"
  acceptCount="100" scheme="https" secure="true"
  clientAuth="false" sslProtocol="TLS" />
-->

<Connector
  className="org.apache.coyote.tomcat4.CoyoteConnector"
  port="8443"
  scheme="https"
  secure="true"
  useURValidationHack="false"
  disableUploadTimeout="true">
</Connector>
```

See the Tomcat documentation for further information.

To define SSL on AIX Java 5, set the `sslProtocol` attribute to `sslProtocol="SSL"` and add the attribute `algorithm="IbmX509"` as follows:

```
<!-- Define a SSL HTTP/1.1 Connector on port 8443 -->
<!--
<Connector port="8443" maxHttpHeaderSize="8192"
  maxThreads="150" minSpareThreads="25" maxSpareThreads="75"
  enableLookups="false" disableUploadTimeout="true"
  acceptCount="100" scheme="https" secure="true"
  clientAuth="false" sslProtocol="SSL"
  algorithm="IbmX509" />
-->
```

For more information, see the Tomcat SSL documentation.

### Modify `catalina.bat` or `catalina.sh`

This section describes the tasks to perform for Tomcat versions before 5.5.

For the QAD QXtend servlets to work with the HTTPS connector, you must set the properties in `TOMCAT_HOME/bin/catalina.bat` for Windows and `TOMCAT_HOME\bin\catalina.sh` for UNIX. The QAD QXtend servlets properties are:

```
-Djavax.net.ssl.trustStore=<Location of the keystore>
-Djavax.net.ssl.trustStorePassword=<keystore password>
-Djava.protocol.handler.pkgs=com.sun.net.ssl.internal.www.protocol
```

Enter these lines into the file after each instance of `RUNJDB` or `RUNJAVA`. One entry is shown below as an example; however, you must typically make this change in seven or eight locations.

```
exec "$_RUNJDB" $JAVA_OPTS $CATALINA_OPTS \
  -Djavax.net.ssl.trustStore=<Location of the keystore> \
  -Djavax.net.ssl.trustStorePassword=<keystore password> \
  -Djava.protocol.handler.pkgs=\com.sun.net.ssl.internal.www.protocol \
  -Djava.endorsed.dirs="$JAVA_ENDORSED_DIRS" -classpath "$CLASSPATH" \
  -sourcepath "$CATALINA_HOME"/../../jakarta-tomcat-4.0/catalina/src/share \
  -Djava.security.manager \
  -Djava.security.policy=="$CATALINA_BASE"/conf/catalina.policy \
  -Dcatalina.base="$CATALINA_BASE" \
  -Dcatalina.home="$CATALINA_HOME" \
  -Djava.io.tmpdir="$CATALINA_TMPDIR" \
  org.apache.catalina.startup.Bootstrap "$@" start
else
exec "$_RUNJDB" $JAVA_OPTS $CATALINA_OPTS \
  -Djavax.net.ssl.trustStore=<The location of the keystore> \
  ...
```

### Create Trusted Security Certificates

The machine on which Tomcat is running requires a trusted security certificate. If the HTTPS client cannot find a trusted security certificate on the QAD QXtend server, it may issue a warning to that effect or it may refuse to work with a HTTPS connection to the server. This behavior can cause a fault on the client side.

You must generate a self-signed server certificate using the Java keytool. This is done as follows:

- 1 In a command window, navigate to a temporary directory such as `c:\temp` and enter the following command:

```
%JAVA_HOME%\bin\keytool -genkey -alias tomcat -keyalg RSA -keystore
c:\temp\keystore
```

- 2 The system prompts you to enter the keystore password. The default SSL password for Tomcat is `changeit`. If you change this, you must place the new password in `server.xml` and `catalina.bat`.

You are prompted to enter your first and last name.

- 3 Enter the name of the host where the QXI WebApp is installed; for example, `corp_pc01`. It must be the same host specified in `qxtendconfig.xml` for `MessageReceiverServlet`. This and all subsequent prompts use the format:

[Unknown]: *<Enter data value here.>*

- 4 The system prompts you for the following information:

- The name of your organizational unit
- The name of your organization
- The name of your city or locality
- The name of your state or province
- The two-letter country code for this unit

Enter the appropriate values for your implementation.

- 5 The system prompts you to confirm the following information:

Is CN=corp\_pc01, OU=QAD, O=QAD, L=Summerland, ST=California, C=US correct?

[no]: y

The common name (CN) must be the correct QXI WebApp host or the Web service call reports the validation error “HTTPS hostname wrong.”

- 6 The system prompts you to enter the key password for `<tomcat>`.

Press Enter if the key password for Tomcat is the same as the keystore password. Do not attempt this unless you are an experienced HTTPS user.

See the Java tools documentation for details.

## Verify QXO Server Installation

This test verifies that the QXO Server was correctly installed, the required AppServer was correctly configured, and the QXO user interface was correctly installed and configured.

To perform the test, do the following:

- 1 Ensure the Tomcat AppServer is running.
- 2 Ensure the Progress AppServer is running.
- 3 Ensure the QAD Enterprise Applications production and `qxevents` database servers are running.
- 4 Start a browser session on the client and set the URL to:

`http://<qxtendhost>:<port>/<QXO webapp>`

5 The QXO Dashboard should display as shown in Figure 5.2.

**Fig. 5.2**  
QXO Dashboard

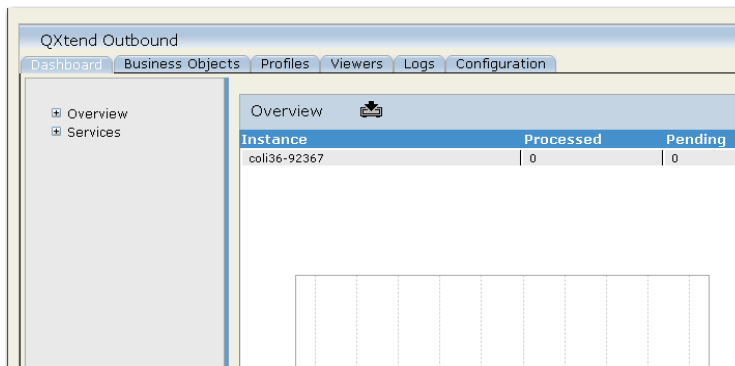

**Note** See *User Guide: QAD QXtend* for details about the administrative functions.

If your system is not configured properly, the following message might display when you try to display the QXO Console:

```
Unable to start Appserver AppServer://servername:9999/QXOSession appserver
com.qad.qxo.proxy.QXOProxy
```

This message indicates that one of the following has occurred:

- The AppServer did not start on the server *servername*, possibly because of configuration problems.
- The configuration file for the QXO UI (*environmentmanager.xml*) was not correctly modified to point to the AppServer. Verify that:
  - The name of the server running the AppServer is correct.
  - The correct port is specified for the NameServer with which the AppServer is registered.
  - The name of the AppServer is correct. The default name is *qxoui\_AS*, but you can modify this if multiple AppServers are running on the same machine.

## Verify QXO Server and Source Application Connection

This test ensures that the QXO server connects correctly to the *qxevents* database. It assumes that a suitable QXO-adapted QAD Enterprise Applications is available as a source application.

- 1 Start a browser session on the client and set the URL to:
 

```
http://<qxtendhost>:<port>/<QXO webapp>
```
- 2 In the QXO Console, click the Configuration tab and then the Source Applications node in the left-hand tree view. Create a new source application and define its details.
- 3 Click Event Types under your Source Application and ensure that the event types appear.

If your system is not configured properly, the following message might display when you try to display the event types:

```
Database not available
```

This message indicates that one of the following has occurred:

- The database name is configured incorrectly; correct the database name using the Configuration tab.
- The qxevents database server is not running. Verify that the servers are started for the QAD Enterprise Applications databases including qxevents using your `start.DBName` script.

A blank screen indicates that the database connection parameters for the qxevents database are incorrect. Correct the database connection parameters using the Configuration tab.

## Verify PROPATH and Event Recording

This test ensures that the QAD Enterprise Applications database set was configured correctly with the correct PROPATH and database connections. It verifies that an event is recorded when a change occurs in the source application.

It assumes that a suitable QXO-adapted QAD Enterprise Applications is available as a source application.

To perform the test, do the following:

- 1 Start a browser session on the client and set the URL to:  
`http://<qxtendhost>:<port>/<QXO webapp>`
- 2 In the QXO Console, click the Configuration tab and then click Event Types under your source application.
- 3 Edit the source application event types and select the Active check box for the `cm_mstr` event type.
- 4 Launch a QAD Enterprise Applications session. Use Customer Maintenance (2.1.1) to create a new customer.

If the following error message displays in Customer Maintenance, the PROPATH is incorrect:

```
** "filename" was not found. (293)
```

Correct the PROPATH for the QXO database set and create new startup scripts.

- 5 Go to QXtend Outbound Control (36.16.19) and verify that QXO is enabled in the QAD application. The Enable QXtend Outbound option must be set to Yes before any event is logged to the qxevents database.
  - 6 From your QAD Enterprise Applications session, access the Progress Editor. From Tools|Data Dictionary|Database, choose Select Working Database and select the qxevents database.
  - 7 Choose Admin|Dump Data and Definitions|Table Contents (.d) file.
  - 8 Choose the `ert_app_event` table, press Go, and specify an output file name.
  - 9 Open the output file in a text editor and verify it contains a record similar to the following:  
`1 "0x0057d684" "TMP1497" "mfg" "" "cm_mstr" 2453319.175590277 "mfgprod" 1 3`
- If no records display in the file, one of the following may have occurred:

- The `cm_mstr` event type is not active. Restart this test and ensure you select the Active check box for `cm_mstr` in the QXO Console.

- The source application database schema was not updated correctly during installation. Verify that replication write and replication delete triggers exist for the cm\_mstr table. If these triggers do not exist, you must reinstall the adapter to QAD Enterprise Applications.

To verify the existence of the triggers:

- 1 From your QAD Enterprise Applications session, access the Progress Editor.
- 2 From Tools|Data Dictionary|Database, choose Select Working Database and select the qaddb database.
- 3 Choose Database|Reports|Trigger.
- 4 In the Trigger Report, verify that the following information displays:

Table/Field Name	Event	Check CRC	Flags	Procedure
cm_mstr	RP-DEL	no		cmrd.t
	RP-WRI	no		cmrw.t

## Verify QXO Messages

This test ensures that a subscriber to a particular profile receives an outbound message after a change to the profile. It assumes that the QAD Enterprise Applications source application was added and the databases were correctly set up.

- 1 Load the Customer business object (Customer.xml) using the XML Import screen under the Configuration tab in the QXO Console.
- 2 In the Configuration tab, click Subscribers in the navigation tree and create a new subscriber.
- 3 Register the default profile for the Customer BO with the subscriber.
- 4 In the Configuration tab, click Event Services in the navigation tree and create a new event service.
- 5 Register the QAD Enterprise Applications source application with the event service.
- 6 In the Configuration tab, click Message Publishers in the navigation tree and create a new message publisher session profile.
- 7 Register the Customer BO with the message publisher.
- 8 In the Configuration tab, click Message Senders in the navigation tree and create a new message sender session profile.
- 9 Register the new subscriber with the message sender.
- 10 In the QXO Dashboard, start the event service, message publisher, and message sender sessions. The event created in the previous test when you created a new customer will be processed by QXO.
- 11 Click the Log tab in the QXO Console to verify that QXtend sends a message to the subscriber you created.

## Check PROPATH for QXtend Adapter in .NET UI Scripts

After you have successfully installed QXtend with the .NET UI plug-in, use the following steps to verify that the `PROPATH` entries in the .NET UI `connmgr` and `telnet` scripts contain the QXtend adapter:

- 1 Open the `connmgr.Demonstration` and `telnet.Demonstration` scripts. For QAD Enterprise Edition, they are located in the `$QDT_HOME/envs/$ENV_NAME/scripts` directory. For QAD Standard Edition or previous versions, they are located in the `$MFG_HOME/qadui` directory or another place, depending on how the .NET UI was installed.
- 2 Verify that the QXtend adapter directory is in the `PROPATH`. If it is not, add it.
- 3 Restart the `qadui` AppServer and WebSpeed server.
- 4 Verify that the .NET UI `connmgr` and `telnet` scripts support QXtend by modifying the QAD Enterprise Application data in the .NET UI and examining the data published by QXtend Outbound.  
 QXtend Outbound must be properly configured to do this. Since you can open a typical program in Desktop and Terminal modes in .NET UI, be sure to test both modes.

## Post-upgrade

### QXtend Outbound Configuration

The following steps are required following a QXtend Outbound upgrade:

- 1 Update the source application database details to ensure the `qxevents` database points to the new version's `qxevents` database. This applies when migrating the QXtend Outbound configuration. During an in-place conversion, the existing `qxevents` database specified in the source application connection details is converted to the version.  
 To update the source application database details, go to the QXtend Outbound UI, select the Configuration tab, and make the necessary changes in the Databases pane.
- 2 Verify QXtend Web Service subscribers in QXtend Outbound. For each QXtend Web Service subscriber, verify that the entries in the Tomcat Host, Tomcat Port, and Webapp Name fields point to the new version's Web Application.
- 3 Verify the license manager details for QXtend Outbound. You can set this in QXO by selecting Configuration|Outbound Settings|License Manager.
- 4 You must manually validate all business objects before an event message can be extracted. To validate business objects, select the Business Objects tab, and click Validate All. This regenerates the schema definition for the business objects.

## Post-migration

The following steps are required following a QXtend migration:

- 1** Update the source application database details to ensure the qxevents database points to the new version's qxevents database. This applies when migrating the QXtend Outbound configuration. During an in-place conversion, the existing qxevents database specified in the source application connection details is converted to the version.  
To update the source application database details, go to the QXtend Outbound UI, select the Configuration tab, and make the necessary changes in the Databases pane.
- 2** Verify the QXtend Web Service subscribers in QXtend Outbound. For each QXtend Web Service subscriber, verify that the entries in the Tomcat Host, Tomcat Port, and WebApp Name fields point to the new version's Web application.
- 3** Verify the license manager details for QXtend Outbound. This can be set in QXO by selecting Configuration|Outbound Settings|License Manager.
- 4** Additional work may be required depending on the QXtend version. This is described in a reminder the installer displays after a successful migration.

# Troubleshooting QAD QXtend Installs, Upgrades, and Migrations

This section describes how to resolve QAD QXtend install, upgrade, and migration problems.

**Overview 58**

***Diagnosing the Problem* 58**

***Environment Issues and Common Mistakes* 62**

***Known Issues* 64**

## Overview

This section describes how to resolve issues encountered during or after a QXtend installation, upgrade, or migration.

## Diagnosing the Problem

The Installation Summary screen displays three types of information about the installation or upgrade:

- Status
- Detailed Messages
- Detailed Errors

All system messages generated during installation are recorded in the install log.

## Status

The Status screen uses colored symbols to indicate the status of each component:

- A green check mark indicates the operation was completed successfully (success status).
- A red cross indicates that non-fatal and fatal errors occurred (failure status).
- A blue double arrow indicates a task you can skip (previously completed or irrelevant).

A status also displays for any substeps performed during the installation or upgrade to allow you to easily identify issues. For example, Figure 6.1 shows that installing the Inbound Servlet and Outbound Database consists of several substeps (replace token in archive, loading the database schema, and so on). A status displays for each of these substeps.

**Fig. 6.1**  
Installation Status Screen

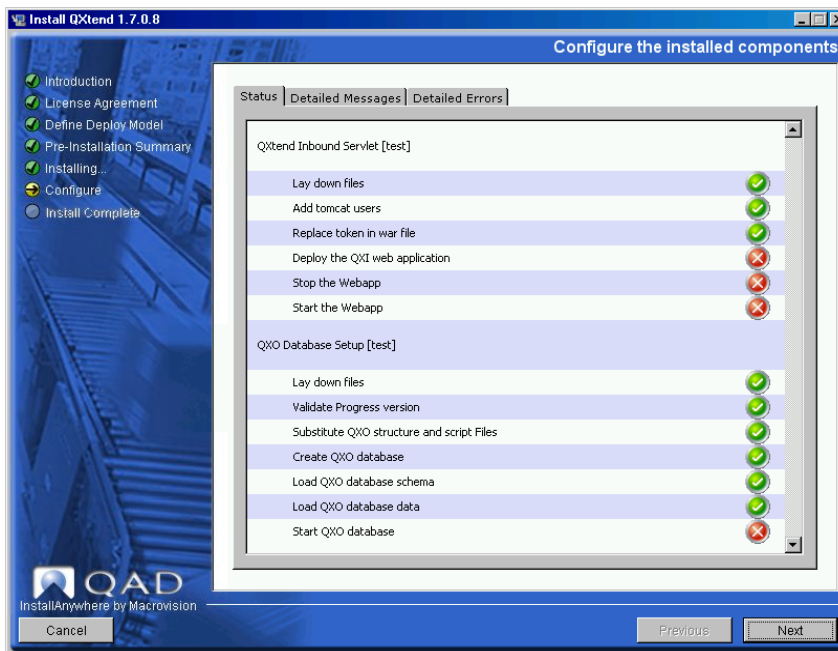

## Detailed Messages

The Detailed Messages screen displays a record of all status messages generated during the installation or upgrade. All of the displayed messages are logged in the install log file.

**Fig. 6.2**  
Installation Detailed Messages Screen

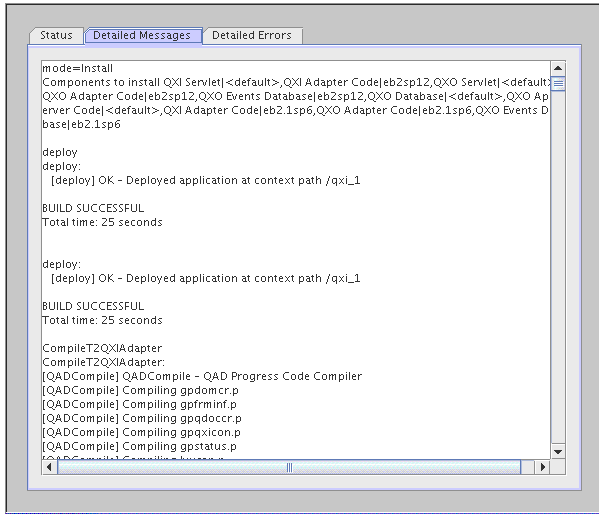

## Detailed Errors

The Detailed Errors screen shows a log of any fatal system errors noted during the installation or upgrade. These messages indicate a serious problem with the system (for example, a corrupted Java or Progress executable). Some of these errors are recorded in the log file.

**Fig. 6.3**  
Installation Detailed Errors Screen

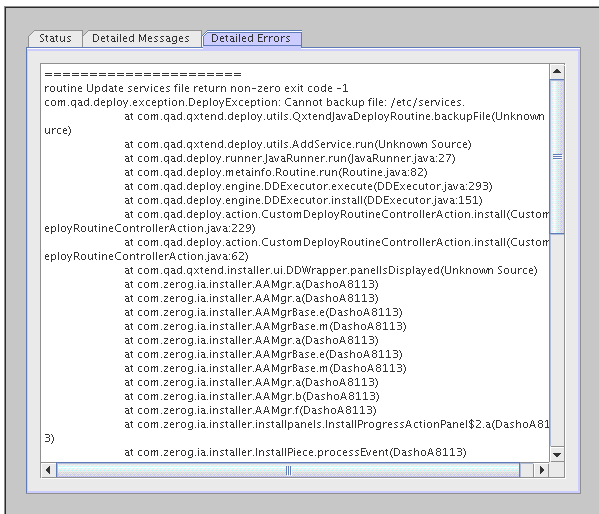

## Checking repository.xml

The installer keeps the installation configuration and status of all install-related tasks in the install repository.xml file.

**Note** Do not manually modify this file. Instead, modify it through the GUI installer (see “Installing, Upgrading, and Migrating QAD QXtend in a GUI Environment” on page 21). Beginning with QXtend 1.6.3, you can also modify the status of routines and therefore modules. For more information see Appendix C, “Process Control,” on page 77.

The repository.xml file can give you a high-level view of the results of an install, particularly when doing a console install, which presents less information.

Figure 6.4 shows the contents of a typical repository.xml file.

**Fig. 6.4**  
repository.xml File

```

<?xml version="1.0" encoding="UTF-8"?>

<repository>
  <environment name="test" createDate="2010-05-25 11:55:55 +00">1
    <product name="QXtend" version="1.6.3" servicePack="IR">2
      <global>
        ...
      </global>
      <defaultconfig>
        ...
      </defaultconfig>
      <host hostname="xxx">3
        <component name="QXI Servlet" copy="default">5
          <install status="Complete" moduleStatus="Complete">
            ...
          </install>
          <parameters>
            ...
          </parameters>
        </component>
        <component name="QXO Servlet" copy="default">
          <install status="Incomplete" moduleStatus="Incomplete">
            <routines>
              <routine name="install" status="Done"/>4
              <routine name="add_tomcat_users" status="Error"/>
              <routine name="replace_token_in_war" status="Pending"/>
              <routine name="deploy_qxo" status="Pending"/>
            </routines>
          </install>
          <parameters>
            ...
          </parameters>
        </component>
      </host>
    </product>
  </environment>
</repository>

```

A repository.xml file has the following features:

- 1 Environment: The name attribute is the environment set during the installation.
- 2 Product: There may be more than one product in the environment. You must verify that the name and version match the targeted install.

- 3 Host: There can be multiple hosts in an installation. Verify this is the correct one.
- 4 Routine: These are granular tasks that the installer performs. A group of routines make up a component. Routines can have a status of Done, Skipped, Error, or Pending.
- 5 Component: The component node is the parent to the status and the parameters. Check the component name and proceed to observe the install or upgrade nodes.
  - a Status: The status of that particular component instance (indicated by the copy attribute). It can be:
    - Complete if all routines are Done
    - Forced Complete if any routine is marked as Skipped
    - Incomplete if any routine is marked as Pending or Error
  - b ModuleStatus: The status of all the instances of a component. If there are three instances (indicated by copy), all three must have a status of Complete or Forced Complete before the ModuleStatus is marked as Complete.

Checking the status of a component (more specifically a routine) leads you to the installation step that failed. This makes the installation log easier to navigate because you know what to look for.

The `repository.xml` file is located under the `data` directory in the `QADDeployService` servlet in the `tomcat/webapps` directory. If you are using a local file, `repository.xml` is in the location specified during the install.

## Reading the Installation Log

The QXtend installation log, named `QXTEND-InstallLog-<TimeStamp>.log`, resides in the configured directory that was chosen when running the installer. The log file captures all of the standard output from the JVM during the install. If you are running the GUI installer, this is the same as the Detailed Messages tab.

If an error occurred, you can read the log file during or after the install. If the pause occurred during installation (see Appendix C, “Process Control,” on page 77), you can look at the file without exiting the installer. In some cases, you can fix the problem and rerun the routine that failed.

If the installation process completed with a non-fatal error, you can identify the error by looking in the `repository.xml` file (see “Checking repository.xml” on page 60). To find the problem, look for the component that owns the failed routine. Then search the log file for the beginning of that component by finding the name followed by the instance in square brackets:

```
QXtend Inbound Servlet [default]
=====
```

The failed routine will have a corresponding ant task you can find by looking for a similarly named ant task to the failed routine:

```
add-tomcat-users:
  [copy] Copying 1 file to /qad/tomcat-164-8110/conf
  [xslt] Processing /qad/tomcat-164-8110/conf/tomcat-users.xml.bak
  to /qad/tomcat-164-8110/conf/tomcat-users.xml
  [xslt] Loading stylesheet
  /tmp/656641.tmp/resources/Transformations/tomcat-users.xsl
```

If the routine is successful, you will see a message similar to this.

```
BUILD SUCCESSFUL
Total time: 1 second
Trying to override old definition of datatype resources
```

If the routine is unsuccessful you will see a message similar to this:

```
BUILD FAILED
java.net.ConnectException: Connection refused
```

The failure message will include a Java stack trace of the error. Since stack traces are sometimes hard to understand, QAD provides Helpful Hints when the installer pauses for an error.

Reading the steps around the error may provide clues regarding its cause.

## Environment Issues and Common Mistakes

This section describes problems that may occur during QXtend installation. For more detailed information regarding potential installation issues, visit the QAD KnowledgeBase or contact QAD support.

### No X11 DISPLAY variable was set

This error appears when you try to run the install in a console without GUI capability. To run the installer in console mode, add the `-i console` option to the command.

### Unable to Deploy

If the Web Applications do not deploy properly, it may have been caused by Tomcat failing to fully start during the install. Verify the Tomcat server is fully operational (a good test is to access the Manager application in your browser). If it is running, but produces out-of-memory exceptions, you can increase the maximum and default Tomcat heap size (`-Xmx` and `-Xms`). See your operating system documentation.

### Cannot Connect to Database

The install log reports this as an error code 14. This probably means the database it is attempting to connect to is not running (if it is trying to connect using client-server or shared-memory mode) or trying to run single-user mode when it is already in use.

### Default Configuration

A default configuration failure is often the result of a few issues.

The Inbound Web application and Outbound AppServer must be running so that the Web Service can be accessed, and in turn, contact the AppServer.

The QAD Enterprise Application databases must be running for the default configuration to create subscribers for the source application.

If the problem seems to be configuration-related, consult the AppServer logs in the server installation logs directory.

## No Features to Install on this Host

The following message may appear during QXtend installation:

The information stored in the QAD Deployment Configuration Service indicates that there are no features to install on this host (xxx). If this is unexpected, you may wish to re-run the installer on a Windows or X-Platform and update the configuration. If this is correct, then continue the installer on the next host. The installer will now exit.

This message indicates there are no installs to do on the machine on which you are running the install. You can continue the install on the servers you are using.

This message can display for a number of reasons:

- In a multi-tier install, when you first run the installer on a PC, it builds the QAD Deployment Service (QADDeployService.V1), interrogates the user for configuration values (data gathering), and attempts to see if it should also deploy on the same PC. Generally, the answer is no because you are just building the configuration data through a GUI interface, but you plan to deploy the components on a different server or servers. In this case, you can safely ignore the message and proceed.
- During `QXtend.bin -i console`, you were prompted for an environment to install and entered an invalid environment name. Most likely, when you ran the installer, you provided an environment name like Test, Prod, and so on. If your answer was not valid, the installer looks in the `repository.xml` file for an environment tag called *<what you entered>*. The tag is missing, resulting in “nothing to install on this Host.” If you forgot your environment name, you can check the `repository.xml` file for the name you provided. You can alternately run a GUI installer and observe the option at the environment selection screen. Then rerun the installer.
- To determine if an incorrect host name was entered, compare xxx from the error message with the result of `hostname` or equivalent command in a console window. When using the QXtend Installer, you should always use the shortened host name (do not include the domain).

## IATEMPDIR Space

The installer needs to self-extract several files before it can run. This can cause an error before the installer finishes loading, particularly when using the bundled Java VM. This occurs because there is insufficient space in the default extract location. To resolve this, you can set the environment variable `IATEMPDIR` to a storage area with sufficient space.

## Java Memory

If you experience out-of-memory errors during installation before the installer finishes initializing, do the following:

- 1 Create a directory called `bin` under `$HOME` as user `mfg`.
- 2 Create a file named `java` under the `bin` directory and add following parameters in the file:
  - `- /opt/java1.5/bin/java -verbose -Djava.awt.headless=true -XX:HeapDumpOnOutOfMemoryError -client`
  - `-Xms1024M -Xmx2048M $@`
  - `-XX:PermSize=512M`

- `-XX:MaxPermSize=512M`
- Set `JAVA_HOME` to `$HOME/bin`.
- Add `$HOME/bin` in the beginning of the `PATH`.

The installer should now be able to complete the installation process.

## UI API Adapter Performance

When using QXtend with AIX, you must change the AIX kernel setting `tcp_nodelayack` to 0. Otherwise, QXtend UI API performance will be severely limited.

## Known Issues

### Installer Menu Items Difficult to Select

Starting the QXtend Installer UI in X-Windows while using X-Windows clients (such as `xterm`) can make installer UI menu items difficult to select.

This is a known environment-related issue with the Java X-Windows component. To work around it, use the Up and Down keys to make a selection.

# Typical Installation Parameters

This section describes the typical parameters provided for basic QXtend installations.

**Overview 66**

**Tokens 66**

**Parameters 66**

## Overview

Beginning with version 1.6.2, QXtend provides a simplified installation process using a default QXtend configuration bundled with the product to automatically populate the various installer fields.

If you wish to modify any of default configuration parameters, use QXtend's advanced installation mode.

## Tokens

Tokens enable you to dynamically reference parameters from other fields. You can use any parameter name as a token by surrounding the parameter name in @ symbols. The tokens also work recursively.

For example, to resolve QXODB\_DIR:

```
QXODB_DIR = @QXOSERVER_DIR@/db
QXOSERVER_DIR = @GLOBAL_QXTEND_DIR@/qxoserver
GLOBAL_QXTEND_DIR = /qad/qxtend
```

The result is:

```
QXODB_DIR = /qad/qxtend/qxoserver/db
```

Values are stored as tokens in the repository and resolved at runtime during configuration in the UI, or at runtime as ant properties.

**Note** During configuration, hovering over a field label displays the corresponding parameter name. If you hover over the field itself, the fully resolved parameter is shown as a tool tip.

## Parameters

The following table describes the parameters provided with the default QXtend configuration.

**Table A.1** Default QXtend Installation Parameters (Page 1 of 6)

Module	Parameter Name	Description	Default Value
QXI Servlet	INBOUND_TOMCAT_ADMIN	Admin Name	admin
QXI Servlet	INBOUND_TOMCAT_HOME	Home Directory	@GLOBAL_TOMCAT_HOME@
QXI Servlet	INBOUND_TOMCAT_HOST	Host	@GLOBAL_INSTALL_HOST@
QXI Servlet	INBOUND_TOMCAT_PASS	Admin Password	mfgpro (encrypted)
QXI Servlet	INBOUND_TOMCAT_PORT	Tomcat Port	@GLOBAL_TOMCAT_PORT@
QXI Servlet	INBOUND_WEBAPP_NAME	WebApp Name	qxi
QXO Database	ADV_DB_CONFIG	Advanced Database Configuration	false
QXO Database	CREATE_QXODB_SERVICE	Create Services File Entry	false
QXO Database	QXODB_BLOCK_SIZE	Block Size	4
QXO Database	QXODB_DIR	Database Directory	@GLOBAL_QXTEND_DIR@\qxodb

**Table A.1** Default QXtend Installation Parameters (Page 2 of 6)

Module	Parameter Name	Description	Default Value
QXO Database	QXODB_DLC	Progress Directory	@GLOBAL_QXTEND_DLC@
QXO Database	QXODB_HOST	Host	
QXO Database	QXODB_PHY	Physical Name	qxodb
QXO Database	QXODB_SERVICE	Service Name	
QXO Database	QXODB_SERVICE_PORT	Service Port	
QXO Database	SA_BEFORE_IMAGE	Before Image	
QXO Database	SA_CONFIG_DATA	Configuration Data	
QXO Database	SA_CONFIG_INDEX	Configuration Indexes	
QXO Database	SA_RAW_MSG	Raw Messages (CLOB)	
QXO Database	SA_SCHEMA_AREA	Schema Area	
QXO Database	SA_SUBSCRIBER_MSG	Subscriber Messages (CLOB)	
QXO Database	SA_TRANS_DATA	Transactional Data	
QXO Database	SA_TRANS_INDEX	Transactional Indexes	
QXO Events	CREATE_QXEVENTS_SERVICE	Create Services File Entry	false
QXO Events	MFG_ADMIN_CONNECTION_TYPE	Connection Type	Mandatory field
QXO Events	MFG_ADMIN_DIR	Database Directory	Depends on connection type
QXO Events	MFG_ADMIN_HOST	Host	Depends on connection type
QXO Events	MFG_ADMIN_MULTI_USER	Multi-user	Depends on connection type
QXO Events	MFG_ADMIN_PHY	Physical Name	Mandatory field
QXO Events	MFG_ADMIN_SERVICE	Service Name	Depends on connection type
QXO Events	MFG_DB_CONNECTION_TYPE	Connection Type	Mandatory field
QXO Events	MFG_DB_DIR	Database Directory	Depends on connection type
QXO Events	MFG_DB_MULTI_USER	Multi-user	Depends on connection type
QXO Events	MFG_DB_PHY	Physical Name	Mandatory field
QXO Events	MFG_DB_SERVICE	Service Name	Depends on connection type
QXO Events	MFG_HOST	Host	Depends on connection type
QXO Events	MFGPRO_DB_DLC	Progress Directory	@MFGPRO_DLC@
QXO Events	QXEVENTS_BLOCK_SIZE	Block Size	4
QXO Events	QXEVENTS_CLIENT_SERVER	Client Server Mode	false
QXO Events	QXEVENTS_DB_PHY	Physical Name	qxevents

**Table A.1** Default QXtend Installation Parameters (Page 3 of 6)

Module	Parameter Name	Description	Default Value
QXO Events	QXEVENTS_DIR	Database Directory	@MFG_DB_DIR@
QXO Events	QXEVENTS_DB_LANG	Database Language	utf
QXO Events	QXEVENTS_HOST	Host	
QXO Events	QXEVENTS_SERVICE	Service Name	
QXO Events	QXEVENTS_SERVICE_PORT	QXO Events	
QXO Server	APPSHELL_SOURCE	.NET UI Home Directory	
QXO Server	APPSRV_ADMIN_SI	AdminServer Port	20931
QXO Server	APPSRV_ADMIN_UI	AdminServer Port	20931
QXO Server	APPSRV_MAX_CONN_SI	AppServer Max Connections	5
QXO Server	APPSRV_MAX_CONN_UI	AppServer Max Connections	5
QXO Server	APPSRV_NAME_SI	AppServer Name	qxosi_AS
QXO Server	APPSRV_NAME_UI	AppServer Name	qxoui_AS
QXO Server	APPSRV_NAMESERVER_SI	NameServer	NS1
QXO Server	APPSRV_NAMESERVER_UI	NameServer	NS1
QXO Server	APPSRV_PORT_SI	AppServer Port	3092
QXO Server	APPSRV_PORT_UI	AppServer Port	3091
QXO Server	QXOSERVER_DIR	Destination Directory	@GLOBAL_QXTEND_DIR@\qxo server
QXO Server	QXOSERVER_DLC	Progress Directory	@GLOBAL_QXTEND_DLC@
QXO Server	QXOSERVER_QXODB_CLIENT_SERVER	Client Server Mode	false
QXO Server	QXOSERVER_QXODB_DIR	Directory	@QXODB_DIR@
QXO Server	QXOSERVER_QXODB_HOST	Host	
QXO Server	QXOSERVER_QXODB_PHY	Physical Name	@QXODB_PHY@
QXO Server	QXOSERVER_QXODB_SERVICE	Service Name	
QXO Server	UPDATE_UBROKER_PROP_SI	Update Ubroker Properties	true
QXO Server	UPDATE_UBROKER_PROP_UI	Update Ubroker Properties	true
QXO Servlet	OUTBOUND_TOMCAT_ADMIN	Admin Name	admin
QXO Servlet	OUTBOUND_TOMCAT_HOME	Home Directory	@GLOBAL_TOMCAT_HOME@
QXO Servlet	OUTBOUND_TOMCAT_HOST	Host	@GLOBAL_INSTALL_HOST@
QXO Servlet	OUTBOUND_TOMCAT_PASS	Admin Password	mfgpro (encrypted)
QXO Servlet	OUTBOUND_TOMCAT_PORT	Port	@GLOBAL_TOMCAT_PORT@
QXO Servlet	OUTBOUND_WEBAPP_NAME	WebApp Name	qxo
QXO Servlet	QXO_AS_HOST	AppServer Host	@GLOBAL_INSTALL_HOST@
QXO Servlet	QXO_AS_NAME	AppServer Name	@APPSRV_NAME_UI@

**Table A.1** Default QXtend Installation Parameters (Page 4 of 6)

Module	Parameter Name	Description	Default Value
QXO Servlet	QXO_AS_NS_PORT	NameServer Port	5162
QXtend Adapter	ADD_CONN_PARAMS	Additional Connection Parameters	
QXtend Adapter	APPSRV_NAME_NATIVE	AppServer Name	qadsi_AS
QXtend Adapter	APPSRV_PORT_NATIVE	AppServer Port	3093
QXtend Adapter	APPSRV_MAX_CONN_NATIVE	AppServer Max Connections	5
QXtend Adapter	APPSRV_NAMESERVER_NATIVE	NameServer Name	NS1
QXtend Adapter	APPSRV_NAMESERVER_PORT_NATIVE	NameServer Port	5162
QXtend Adapter	APPSRV_ADMIN_NATIVE	AdminServer Port	20931
QXtend Adapter	CLIENT_STARTUP_PARAMS	Client Startup Parameters	-rereadnolock -c 30 -d mdy -yy 1920 -Bt 350 -D 100 -mmax 3000 -nb 200 -s 128 -noshvarfix
QXtend Adapter	EMPTY_DATABASE_TYPE	Database Type	Mandatory field
QXtend Adapter	FIN_NAME_SERVER_PORT	NameServer Port	5162
QXtend Adapter	MFG_ADMIN_EMPTY_DB	Admin Empty DB	admempty
QXtend Adapter	MFG_DB_LANG	Database Language	utf
QXtend Adapter	MFG_EMPTY_DB	Empty DB	mfgempty
QXtend Adapter	MFG_EMPTYDB_DIR	Empty DB Directory	@MFG_HOME@\db
QXtend Adapter	MFG_HOME	Home Directory	Mandatory field
QXtend Adapter	MFG_INTERNAL_CODEPAGE	Internal Codepage	utf-8
QXtend Adapter	MFG_PROPATH	MFG/PRO xrc directory	Mandatory field
QXtend Adapter	MFG_SP	Service Pack	Mandatory field
QXtend Adapter	MFG_STREAM_CODEPAGE	Stream Codepage	utf-8
QXtend Adapter	MFG_VERSION	Version	Mandatory field
QXtend Adapter	MFGPRO_DLC	Progress Directory	Mandatory field
QXtend Adapter	QDT_DIR	QDT Directory	Mandatory field (Enterprise Edition only)
QXtend Adapter	QXTEND_ADAPTER_DIR	Destination Directory	@MFG_HOME@\qxtend
QXtend Adapter	UPDATE_UBROKER_PROP_NATIVE	Update Ubroker Properties	true
QXtend Adapter	USE_ALTERNATE_DB_SET	Alternate DB Set	false
Standard Install	GLOBAL_DEFAULT_CONFIG	Default Configuration	true
Standard Install	GLOBAL_QXTEND_DIR	Destination Directory	Mandatory field

**Table A.1** Default QXtend Installation Parameters (Page 5 of 6)

Module	Parameter Name	Description	Default Value
Standard Install	GLOBAL_QXTEND_DLC	Progress Directory	Mandatory field
Standard Install	GLOBAL_TOMCAT_HOME	Home Directory	Mandatory field
Standard Install	GLOBAL_TOMCAT_PORT	Port	Mandatory field
Standard Install	GLOBAL_INSTALL_HOST	Host	Mandatory field
Default Config	ENABLE_DEFAULT_CONFIG		false
Default Config	DEFAULT_CONFIG_OUTBOUND_RECEIVER		QADQXO
Default Config	CP_TELNET_PORT	Telnet Port	23
Default Config	DEFAULT_CONFIG_EVENT_SERVICE		ES1
Default Config	DEFAULT_CONFIG_MSG_PUBLISHER		MP1
Default Config	DEFAULT_CONFIG_MSG_SENDER		MS1
Default Config	DEFAULT_CONFIG_QAD_RECEIVER		QADERP
Default Config	DEFAULT_CONFIG_SOURCE_APP		QADERP
Default Config	CP_LOGIN_PROMPT		login:
Default Config	CP_PASSWORD_PROMPT		word:
Default Config	CP_SERVER_PROMPT		\$
Default Config	CP_CLIENT_SCRIPT		@QXTEND_ADAPTER_DIR@ /scripts/client.qxtend
Default Config	CP_CLIENT_USERNAME		mfg
Default Config	CP_CLIENT_PASSWORD		
Default Config	CP_IS_WINDOWS		false
Default Config	CP_DOMAIN_PROMPT		domain:
Default Config	CP_SERVER_DOMAIN		
Default Config	CP_SERVER_USERNAME		Mandatory field
Default Config	CP_SERVER_PASSWORD		Mandatory field
QXtend QAD .NET UI Plug-in	NET_UI_SERVER_TOMCAT_PORT		@GLOBAL_TOMCAT_PORT@
QXtend QAD .NET UI Plug-in	NET_UI_SERVER_WEBAPP_NAME		qadhome
QXtend QAD .NET UI Plug-in	NET_UI_SERVER_TOMCAT_HOME		@GLOBAL_TOMCAT_HOME@
QXtend QAD .NET UI Plug-in	NET_UI_DIRECT_CONNECT_APPSERVER		false
QXtend QAD .NET UI Plug-in	NET_UI_APPSERVER_NAME		@APPSRV_NAME_UI@
QXtend QAD .NET UI Plug-in	NET_UI_APPSERVER_HOST		@GLOBAL_INSTALL_HOST@
QXtend QAD .NET UI Plug-in	NET_UI_NAME_SERVER_PORT		5162
QXtend QAD .NET UI Plug-in	NET_UI_APPSERVER_PORT		

**Table A.1** Default QXtend Installation Parameters (Page 6 of 6)

Module	Parameter Name	Description	Default Value
QXtend QAD .NET UI Plug-in	NET_UI_INCLUDE_INBOUND		true
QXtend QAD .NET UI Plug-in	NET_UI_INCLUDE_OUTBOUND		true
QAD .NET UI	NET_UI_CONFIG_NAME	QAD .NET UI Configuration Name	qadui



# Default Configuration

This section describes the QXtend default installation configuration.

**Overview** 74

**Default Configuration Process** 74

## Overview

The default configuration feature provides an initial set of configuration data for QXtend. This allows you to quickly set up QXtend or create a template for setting up interoperability.

Once the installation successfully completes the Inbound Servlet, QXO Database, and QXO Server, the installation process calls the ant target that creates the default configuration inside the newly installed QXtend.

You can enable the default configuration through the Typical and Advanced Install. Enabling the default configuration feature creates the following:

### Inbound

- Receiver
- UI, SI, and Fin(QADEE) connection pool for the receiver
- E-mail settings

### Outbound

- Source application
- A subscriber for each domain in the source application
- A default Event Service, Message Publisher, and Message Sender
- E-mail settings

**Note** The installer will attempt to start the QXO Database and AppServers along with the QAD databases. These must all be running to successfully complete a default configuration. Verify they are running before the default configuration routine runs.

## Default Configuration Process

**Fig. B.1**  
Enable Default Configuration in Typical Install

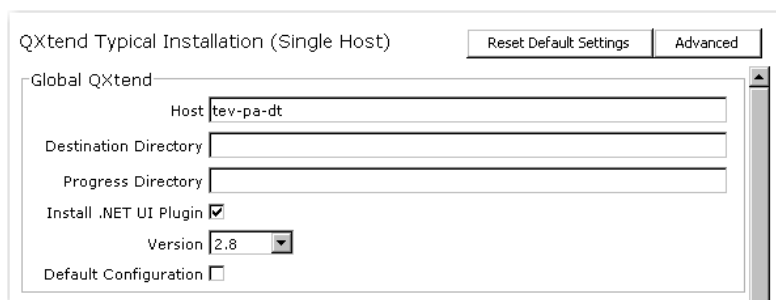

Select the check box and the extra mandatory fields display. For more control over the initial configuration, click the Advanced button. See “Parameters” on page 66 for a list of the parameters used in Default Configuration.

**Fig. B.2**  
Enable Default Configuration in Advanced Install

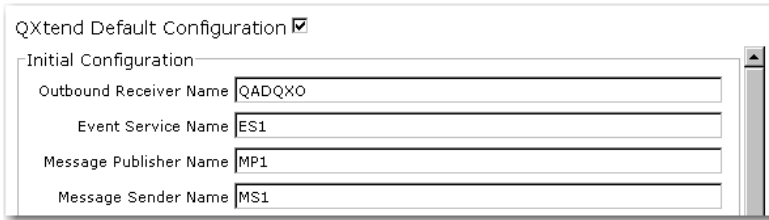

QXtend Default Configuration

Initial Configuration

Outbound Receiver Name QADQXO

Event Service Name ES1

Message Publisher Name MP1

Message Sender Name MS1

This screen displays after configuring the modules for the installation.

The module itself is run once the QXI Servlet, QXO Database, and QXO Server are successfully installed. It can run from any host because it is a Web service call. Once you enable the default configuration, it is initialized automatically by the installer, which uses ant to call the configuration service.

After the default configuration runs, use the following steps to perform a data synchronization:

- 1 Inbound will already have the connection pools and receiver with enabled schemas ready to go.
- 2 Outbound would require the assigning of a source domain (which would be a master domain) for each subscriber.
- 3 Based on the scenario, you would register the required business objects to the message publisher and profiles to subscribers, activate the matching events, and start the services.



# Process Control

This section describes QXtend installation process control.

**Overview** 78

**Using Process Control** 78

## Overview

Process Control provides a higher level of control over the installation process that can greatly enhance the efficiency of the installation process.

## Using Process Control

Click the Modify Status button on the Module Selection Screen.

**Fig. C.1**  
Module Selection Screen

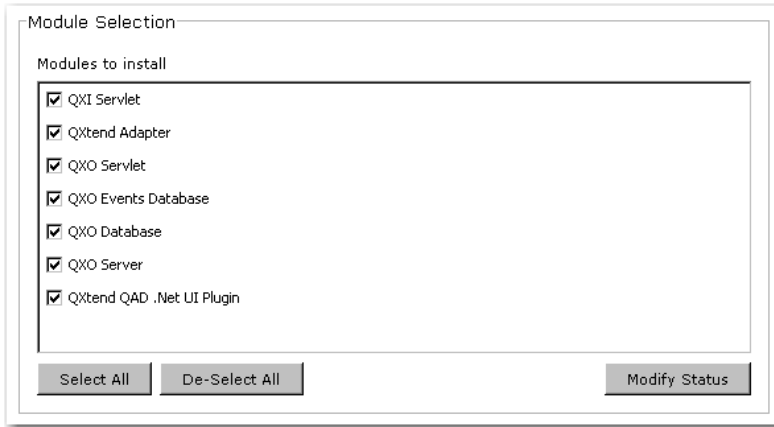

The Modify Status pop-up appears.

**Fig. C.2**  
Modify Status Pop-up

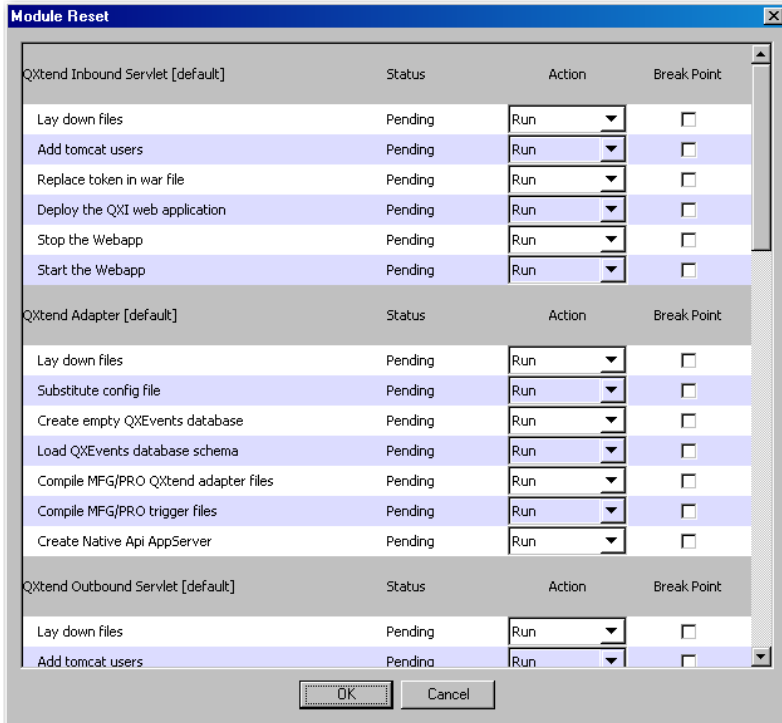

Changing the action via the selection lists enables you to run, rerun, or skip each of the routines. This allows you to skip tasks that were run in previous installs (such as adding the Tomcat users) or to rerun a specific routine (such as compiling the adapter).

**Note** All routines are included for a reason. Skipping a routine could result in an incomplete or non-functional installation. Only skip routines that you are sure are not needed.

Selecting a routine's breakpoint check box will pause the installer before it runs the routine. This allows you to pay particular attention to that part of the install.

If the installer encounters an error while running, it pauses, allowing you to fix environment problems on the fly. For example if Tomcat is not running when the installer tries to deploy the servlets, the installer pauses. You have the chance to investigate using the log file (see Appendix A), see that Tomcat was not started, and start-up Tomcat. The installation continues as if nothing had happened.

**Fig. C.3**  
Console Prompt After an Error

```

QXtend
-----
Component/Routine                                Status
-----
QXtend Inbound Servlet [default]
  Lay down files                                 Done
  Add tomcat users                               Skip
  Replace token in war file                       Done
-----
PAUSE
-----
Routine "Deploy the QXI web application" returned an error.
Helpful Hint: Deploying the servlet requires Tomcat to be running, verify that
it is accessible.
Please also verify the Tomcat server access details are correct.
What would you like to do?
  1- Rerun the previous routine [Deploy the QXI web application]
  2- Run the next routine [Stop the Webapp] without pausing
  3- Run the next routine [Stop the Webapp] and pause
  4- Quit the Installation
Enter your selection: _
  
```

**Fig. C.4**  
GUI Prompt After an Error

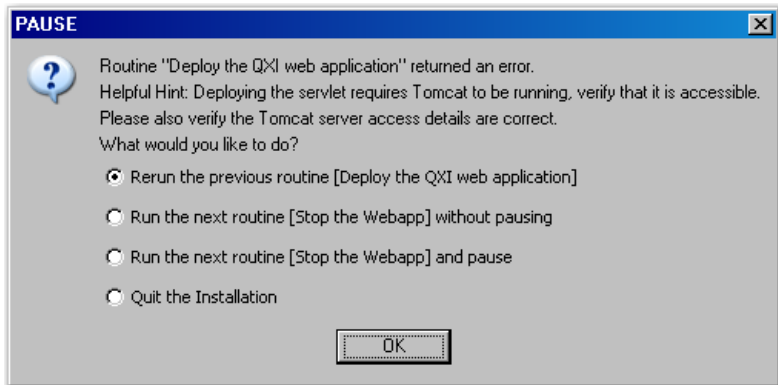

**Note** You cannot correct configuration errors in the repository file. For instance, if you forgot to add a custom element to the compile PROPATH, you cannot add it once the installation starts and rerun the routine after it fails. You must rerun the installer and let it pick up the new value.



# Adapter Program Usage

This section describes QXtend adapter program usage by QXO and QXI.

**Overview 82**

***Adapter Program Utilization* 82**

## Overview

QXtend implementation planning, configuring QXtend to work with customized QAD programs, and QXtend installation regression testing following maintenance program modification often require information about QXtend adapter program usage. This section lists the QXtend adapter programs and whether they are used by QXO or QXI.

The following QXtend Adapter programs are not listed by QAD Enterprise Applications version and service pack. The programs in your environment are only a subset of these programs.

## Adapter Program Utilization

### QXO Programs

The following are QXO programs, or MFG/PRO programs with in-line triggers (some of which have context fixes that are also required by QXI):

gpqxocnf.p, gpqxohdl.p, gpqxost.i, qxodef.i, qxoevent.i, qxoevent.p,  
 qxoglob.i, qxopm.p, qxotrig.i, qxotrign.i, adcamt.p, adcertmt.p, adcsmt.p,  
 adctrymt.p, adstmt.p, advnmt.p, glacmt.p, glcalmt.p, glfmmt.p, gpcontxt.i,  
 gpisapi.i, icstmt.p, mccuacmt.p, mccumt.p, mcexrmt.p, mgcodem1.p, mgcodemt.p,  
 ppcommt.p, ppplmt1.p, pppsmt01.p, ppptmta.p, ppptmtb.p, rcctwbal.p, rcsomt.p,  
 soivpst1.p, sosomt1.p.

### QXI Programs

The following are QXI-only programs that contain context fixes to make them work with QXI:

adcsmt.p, adstiq.p, advnai.p, advnai01.p, advnairs.p, advngtad.i, advngtsp.i,  
 applhelp.p, apvomta.p, apvomta5.p, apvombt.p, arcsrp03.p, ardurpa.p,  
 arsbac01.p, assedef.i, assettrp.i, assettrq.i, blankpage.p, bmpsmt.p,  
 bmttps.i, bussvc.i, cmbkmta.p, compile.p, csptmt3a.p, datetime.i, domtitle.p,  
 drppm.p, dscontxt.i, dsdois.p, dsexcpn.i, dsreqexc.i, ecapsbmt.p, eddmnset.i,  
 eddomchg.p, edimsh02.p, edmfd.p, edmfdd.p, edmid.p, edmidd.p, eds.d.p, edsdd.p,  
 edxfd.p, edxfdd.p, excpmgpr.i, excpmsgs.i, fsbmismt.p, fscaimta.p, fscamte.p,  
 fscarmt.p, fscareo1.p, fscarmta.p, fscarmtb.p, fscarmtc.p, fscarmtm.p,  
 fscarmtr.p, fsci2frm.i, fsegrp03.p, fseomt02.p, fsquem1a.p, fsquem2a.p,  
 fsquem3a.p, fsquem4a.p, fsrmttu.p, fssam01.p, fssama01.p, fssamt1.p,  
 fssamt.m.p, fssrmg.p, fstzsel.p, GetTemplates.p, glcctrra.p, glcrfmt.p,  
 gldabrp.p, gldabrpa.p, gldyiq2.p, glenchg.p, glrtrmta.p, glrvmta.p, gltriq2.p,  
 gltriq2a.p, gltriq2b.p, gltriq2c.p, gltriq2e.p, gltrmta.p, gpaigach.p,  
 gpaighst.i, gpapphlp.p, gpaudd.p, gpcmmt.p, gpcmmt01.p, gpdomcr.i, gpdomcr.p,  
 gpfrcalc.p, gpfrlwt.p, gpgenfld.p, gpgetver.p, gpisutf8.i, gpiswrap.i,  
 gplabel.p, gplocale.p, gpmenupl.p, gpmfgusr.p, gppage.p, gpqdoccr.p,  
 gpqxicon.p, gpqdocrs.p, gpqxtdp.p, gprunp.i, gpstatus.p, gpttcmmt.i,





# Index

## A

- adapter program usage 81
- AdminServer requirements 9
- AppServer requirements 9

## C

- catalina.bat 50
- catalina.sh 50
- character environment
  - installation 44
  - migration 44
  - upgrade 44
- client requirements 10

## D

- default configuration 73
- deployment
  - options 4

## E

- environment specification 25

## G

- Georgia SoftWorks (GSNTS)
  - installing 12
  - registering 12

## H

- HTTPS support 49

## I

- install summary 58
- installation overview 6
- installer
  - limitations 20
  - startup 23
- installing QXtend 21, 26

## J

- Java keytool 50

## L

- license agreement 23
- Linux environment 4
- logging in 48

## M

- migrating QXtend 21, 40

## N

- .NET
  - AppShell plug-ins 3
  - menu configuration 54
- NameServer requirements 9

## O

- operating systems 10

## P

- post-installation procedures 48
- pre-install summary 43
- prerequisites 11
- process control 77
- Progress
  - AdminServer 9
  - AppServer 9
  - NameServer 9
- PROPATH configuration 53

## Q

- QAD Deployment Configuration Service (QDCS) 4
- QAD QXtend Inbound (QXI)
  - server requirements 8
  - servlet configuration 29, 38
- QAD QXtend Outbound (QXO)
  - messages 54
  - QXtendInstallLog file 66
  - server requirements 8
  - servlet configuration 31
  - starting 52
- QDCS file hierarchy 5
- QDCS. *See* QAD Deployment Configuration Service
- QDoc requestors 49
- qxevents database configuration 39
- qxodb configuration 39
- QXtendInstallLog file 66

## R

- requirements
  - software 8
  - system 7

## S

- Secure Socket Layer (SSL) 49
- security
  - certificates 50
  - Secure Sockets Layer (SSL) 49
- single-tier deployment 4
- software requirements 8

- summary
  - install 58
  - pre-install 43
- supporting technologies 9
- system
  - errors 59
  - requirements 7

**T**

- telnet server
  - registering on Windows 12
  - requirements 9

- third-party requirements 9
- Tomcat
  - installation 14
  - requirements 9
- troubleshooting 57
- trusted security certificate 50
- typical installation parameters 65

**U**

- UNIX environment 4
- upgrading QXtend 21, 37
- user IDs 49