

# QAD Warehousing Release Notes

June 2011

These release notes include information about the latest fixes and changes for QAD Warehousing, formally called Advanced Inventory Management (AIM), release 3.0.7 for QAD Standard Edition (as well as earlier releases of MFG/PRO eB2.1). These changes may affect the way you implement and use QAD Warehousing. Review this document before installing the new QAD Warehousing 3.0.7 release.

QAD highly recommends that you implement the latest QAD Warehousing release available. Check the QAD Web site to make sure you have the latest QAD Warehousing release notes, installation guide, and installation media:

<http://support.qad.com/>

Use the following list to find a specific release:

<b><i>Release Notes for Current Release</i></b>	<b>2</b>
<b><i>Release Notes for Version 3.0.6</i></b>	<b>5</b>
<b><i>Release Notes for Version 3.0.5</i></b>	<b>8</b>
<b><i>Release Notes for Version 3.0.4</i></b>	<b>16</b>
<b><i>Release Notes for Version 3.0.3 and SSD 3.0.3</i></b>	<b>19</b>
<b><i>Release Notes for Version 3.0.2 and SSD 3.0.2</i></b>	<b>26</b>
<b><i>Release Notes for Version 3.0 and SSD 3.0</i></b>	<b>29</b>
<b><i>Release Notes for Version 2.3c.1 and SSD 2.3c.1</i></b>	<b>38</b>
<b><i>Release Notes for Version 2.3c and SSD 2.3c</i></b>	<b>39</b>
<b><i>Release Notes for Version 2.3b</i></b>	<b>48</b>
<b><i>Release Notes for Version 2.3a</i></b>	<b>54</b>
<b><i>Release Notes for Version 2.2a and SSD 2.2.a</i></b>	<b>65</b>

# Release Notes for Current Release

**QAD Warehousing Version:** 3.0.7

**Release Date:** June 2011

**Compatibility for 3.0.7:** eB2.1 Service Pack 2 to Service Pack 4, QAD 2007 and 2007.1, QAD 2008, 2008.1, 2009, 2010, and 2011 Standard Edition (SE)

**Note** QAD Warehousing supports only the Progress database.

**Supported languages:** US English, Castilian Spanish, Dutch, French, German, Italian, Polish, Brazilian Portuguese, Japanese, Chinese, Traditional Chinese, Slovak, Latin Spanish, Czech, Lithuanian, and Russian

**User Guide:** *QAD Warehousing*, item 70-3154A

**Installation Guide:** *QAD Warehousing*, item 78-0946A

## New Features

The product name was changed from Advanced Inventory Management to QAD Warehousing in this release. Changes to this version of QAD Warehousing mainly consist of compatibility with the QAD SE 2011 release.

## Fixes

This version of QAD Warehousing includes the following fixes:

- Picklist/Pre-shipper - Automatic (7.9.1) now correctly defaults Consume Req as Yes in Pre-Shipper/Shipper Workbench (7.9.2) for all pre-shippers that the system generates for the selection criteria of required scheduled orders. It also prevents re-creation of already created pre-shippers.
- The system no longer prevents next tasks from displaying in succession. An issue was corrected in which the system hard-assigned transactions, thereby preventing tasks from showing as the next task for warehouse users other than the assigned user.
- The RF Container Move (3.4) option now correctly prompts for the location if the pallet is not found in the current location.
- The RF Ship Truck (3.5) option now correctly processes distribution orders on eB2.1 from Service Pack 2 to Service Pack 8.
- When you attempt to modify an existing shipper in Pre-Shipper/Shipper Workbench (7.9.2), the program now correctly displays the Modification not allowed. Warehouse transactions exist error when unconfirmed transactions exist for the shipper. Previously, only the error number displayed.
- The RF Location Audit (1.4) option now correctly changes the item number when warehouse staff enter a new item number after scrolling down a list of items. Previously, the system did not change the item number and displayed the previous item.
- An issue with QAD Warehousing's Labor Management (80.11) module was corrected. Previously, the Labor Management module did not consider warehousing TranD or TranH tasks for alternate tasks.
- Logistic Palletization/Transfer (80.17.17) no longer prints the identification document with the destination location as a question mark (?).

- Distributed Order Receipt (12.15.20) no longer displays a Progress error, informing you that the shared variable use-ship data was not created. It also now correctly lets you receive distribution orders when you set Multi Entry to Yes.
- Work Order Release/Print (16.6) now correctly creates a picking work order task (PICK-WO task) with the correct expected quantity when you set Allow Split to Yes for the alternate UM in which the inventory is held in the storage location group (SLG). Previously, the system created a PICK-WO task with the expected quantity truncated to the nearest integer.
- Distributed Order Receipt (12.15.20) no longer creates a default multi-entry record with a zero quantity, during a non-palleted receipt of zero quantity in the item's default UM. Previously, the system created a default multi-entry record with zero quantity and displayed an error in this scenario.
- The RF Location Audit (1.4) option now displays the `RCNT Task Created` warning message when the count is out of tolerance. The program now also automatically creates the recount task. Previously, no warning message displayed.
- The system no longer incorrectly calls programs while using the Lithuanian version of QAD Warehousing.
- The system now correctly displays the shortcut key information—that is, F4=End, D=Load Details, and so on—at the bottom of the display when you select the D(etails) option in Wave Selection (80.15.1). Also, in the same program, when users select the W(orkload) option and no records are found, the system now correctly shows the workload frame.
- Transactions by Reference Inq (80.9.7) now has an improved performance when you enter non-blank values for the Reference, Site, and Warehouse fields. Previously, the performance was poor.
- Inventory Detail Maintenance (80.8.14) now displays the data in the lookup browses for the Lot/Serial and Ref fields. Previously, no data was displayed in the lookup browses for these fields.
- The RF Batch Pick-SO (3.1) option no longer rounds the actual quantity to two decimal places in the Qty field when you confirm the picking task for a sales order (PICK-SO task).
- The RF Login screen:
  - No longer displays Progress errors
  - Correctly displays field help when warehouse staff select the help from the Login UserID field
  - Correctly displays an `invalid location` message when warehouse staff enter an invalid location in the login's Location field
- Work Order Release/Print (16.6) now creates a picking task for a work order (PICK-WO task) for a partially picked decimal quantity. Previously, the system did not create the PICK-WO task.
- The .NET UI version of Item Master Maintenance (80.4.5) now correctly sets the Ref field in the Inspection Data frame. Previously, the system set the field incorrectly.
- Location Maintenance (80.3.13.1) now correctly displays the capacity value when you define:
  - More than one unit of measure as a limit for the location
  - A net weight unit of measure for the item in Item Master Maintenance (1.4.1) that is same as the unit of measure defined for the location
- The RF Batch Pick-SO (3.1) option no longer displays a Progress error and no longer goes into an infinite loop in Polish versions of QAD Warehousing when translated labels are longer than English labels.
- The RF Batch Pick SO (3.1) option now correctly assigns the lot/serial number in the target location after staff pick inventory when you set:
  - Scan Lot/Serial to Yes in Batch Picking Control File (80.15.24)
  - To Lot/Serial to No Change in Internal Routing Maintenance (80.2.5)

- The RF Location Audit (1.4) option no longer creates a new recount task when that task is already open for an item in the same site, warehouse, and location with the same lot and reference.
- Movement Conf. By Transaction (80.8.1) now confirms a change in quantity and displays a confirmation of the quantity change when you increase the quantity. Previously, the quantity increase was accepted without confirmation.
- The RF Preship Sel Task (1.7) option no longer displays a Progress error when warehouse staff change the Loc, Lot/Serial, or Ref fields when confirming a pick task.
- The RF transfer (1.3) option now accepts more than eight characters in the Ref field. Previously, staff could enter only a maximum of eight characters.
- Cycle Count Generation (80.8.12) no longer creates cycle count tasks for items/locations for which the system already created tasks and dated the creation. Previously, the date-created criteria did not exist; therefore, the system created tasks for all items/locations.
- QAD Warehousing now works correctly with the QAD Customer Relationship Management (CRM) product, versions 6.4 and higher.
- Movement Conf. Workbench (80.8.4) now correctly displays the `This Change Is Not Currently Supported` error when staff modify the lot/serial and reference of the from location to an item. Previously, the system displayed an error, but the error message was incorrect.
- Logistic Palletization/Transfer (80.17.17) now correctly displays inventory information for the Lot/Serial and Ref fields lookup browses for an item in the Logistic Palletization/Transfer program.
- Batch picking functions (80.15) no longer lock due to issues with the TranD transactions.
- The system no longer displays a system error message, informing you of too many block levels, during several processes.
- The system now correctly creates `sr_wkfl` records, which let the system create pallets IDs when warehouse staff receive purchase orders in QAD SE environments.

# Release Notes for Version 3.0.6

**Advanced Inventory Management Version:** 3.0.6

**Release Date:** July 2010

**Compatibility for 3.0.6:** eB2.1 Service Pack 2 to Service Pack 4, QAD 2007 and 2007.1, QAD 2008, 2008.1, 2009, and 2010 Standard Edition

**Note** QAD Warehousing supports only the Progress database.

**Supported languages:** US English, Castilian Spanish, Dutch, French, German, Italian, Polish, Brazilian Portuguese, Japanese, Chinese, Traditional Chinese, Slovak, Latin Spanish, Czech, Lithuanian, and Russian

**User Guide:** *Advanced Inventory Management*, item 78-0650B

**Installation Guide:** *Advanced Inventory Management*, item 78-0649C

## New Features

- Wave planning now supports kits. New fields in Wave Planning Control (80.15.23) let you specify whether the system:
  - Applies pick logic and creates detailed inventory allocations for components of configured items.
  - Selects only configured kit sales order lines with a general allocation when it selects orders for a wave in Wave Selection (80.15.1).
  - Determines the component of the kit with the least quantity available to allocate. The quantity to ship for the kit item is set to this quantity, ensuring that complete kits are shipped.

The system now creates pick and wave replenishment tasks for kit components. During wave release and release group creation/activation, all appropriate algorithms and functions now support kits. Finally, wave inquiries and reports display data for kits.

- Switching to different lots or references is now available for batch picking; see “Picking for Different Lot/Serial or References” on page 5.

## Picking for Different Lot/Serial or References

When warehouse staff pick for orders, AIM typically allocates specific pallets to be picked as specified by the appropriate algorithm selected; however, many warehouses have multiple pallets containing the same item that are housed in the same warehouse location. For more efficient picking, staff can now pick pallets with different lot/serial or reference numbers than those assigned to be picked by the system. By adding the flexibility to pick other pallets for the same item, warehouse staff can ship and complete the order expeditiously.

You set fields in AIM so that warehouse users who access the following can switch location, lot/serial, or reference numbers to substitute pallets when confirming tasks on the RF:

- RF Next Task (1.1) option
- RF Select Task (1.2) option
- Batch Pick SO/DO (3.1) or Batch Pick All (3.2)

**Note** Batch picking does not support picking for different lot/serial or reference numbers.

You specify a substitute pallet or reference in the same location or another location by setting existing fields in the Transaction Confirmation Defaults frame of Warehouse Control File Maint (80.1.24). A new

Expire Date (Days) field was added to the Transaction Confirmation Defaults frame that works with the From Location Option, From Lot/Serial Option, and From Reference Option fields when specifying different lot/serial/reference numbers.

Use the Expire Date (Days) field to specify the maximum number of days (0 to 9999) that the expiration date of the new pallet can differ from the expiration date of the original pallet. For example, if you enter 5, and the expiration date of the original pallet is 12/1/2008, then the expiration date of the new pallet must fall between 12/1/2008 and 12/6/2008. The default value for this field is 0, which means that the expiration date of the original pallet must match the expiration date of the new pallet.

## Fixes for AIM 3.0.6

- 1 Wave Selection (80.15.1) now correctly calculates and displays the net weight and number of lines for a multi-line sales order when you change the priority for one line from the default priority you specify in Order Maintenance (80.14.1) for sales order. Previously, net weight and number of lines were incorrect.
- 2 Replenishment Request (80.16.5) now replenishes the inventory in the base unit of measure (UM) when:
  - You do not set the Logistic UM field as the base UM in Item-Warehouse Maintenance (80.4.11) for the item.
  - You set the Sizing Type field of the base UM to blank in Alternate Unit of Measure Maint (80.5.1).
  - The location to be replenished is a dedicated and mixed replenishment.
- 3 The RF Batch Pick-SO function (3.1) now updates the start date, start time, and start user ID when you click the End function key after partially confirming the sales order quantity. Previously, the values were blank.
- 4 Item Number Change (1.4.13 I) now copies data to the new item from the old AIM item when you assign warehouse master-list as a location to the old item in Item Master Maintenance (1.4.1). Previously, the system displayed an error, indicating the item number did not exist.
- 5 The RF Issues - Unplanned function (3.7) now correctly prints only one tag for the item issued when you set Print Unpl. Issue Tag field to Yes in Item-Warehouse Maintenance (80.4.11). Previously, the system printed as many tags as the quantity issued.
- 6 Transactions Detail Inquiry (3.21.1) no longer displays a transaction history record with a zero quantity when you complete the shipment using Sales Order Shipments (7.9.15) and you set:
  - Zero as the quantity at the line level
  - Multi Entry to Yes when entering the quantity in multiple lots
- 7 Wave Unprocessed Orders Inquiry (80.15.22.1) now displays the following message when you set Print Packing List to No for the sales order in Sales Order Maintenance (7.1.1) and you do not select the sales order in Wave Selection (80.15.1).  
.SELECT: Skipped
  - AIM no longer locks records when you run several inquiries and reports simultaneously on the same .NET UI session.
- 8 Pallet Constitution/Transfer (80.17.20) now correctly prints the identification label only when you set Print ID to Yes in Pallet Constitution/Transfer (80.17.20). Previously, the system printed the ID label even though you set the Print ID to No.
- 9 You can now change the password in the RF device when the password has expired. Previously, the system did not display the password-changing screen in the RF device.

- 10 Pre-Shipper/Shipper Workbench (7.9.2) no longer lets you delete the entire pre-shipper when lines are active in the RF Batch Pick function (3.1) of the same pre-shipper and you select the open transaction line, then select the Delete Pre-Shipper/Shipper option. In this scenario, the system now displays an error message.
- 11 Work Order Release/Print (16.6) now overpicks the work order in multiples when you set the Pick Multi UM and Over Pick fields to Yes in Storage Location Group Maint. (80.3.1). Previously, the system picked the work order quantity.
- 12 The RF PO RECEIPT (1.8) option now correctly creates receipt transactions for all items when you receive one or multiple lots or items on the same pallet. Previously, the system created a receipt transaction only for the first lot or item you received.
- 13 Purchase Order Receipts (5.13.1) no longer displays a Progress error message in .NET UI during receipt of multiple pallets when you set Multi Entry to Yes. Previously, the system displayed the Progress error.
- 14 Order Detail Status Inquiry (80.15.9) now correctly displays sales order details without displaying an error message in the .NET UI environment. Previously, the system displayed an error message and did not display sales order details.
- 15 Movement Conf. By Transaction (80.8.1) no longer confirms the transactions and displays an error while confirming transactions for a closed period. Previously, the system created unposted GL transactions in Unposted Transaction Register (25.13.14).
- 16 Customer-Item Status Report (80.4.19) no longer displays Progress error messages when you delete a customer after defining the customer-item status.
- 17 The system now functions correctly during a re-pick for a picking task without pre-shippers. Previously, when the original task was without a pre-shipper, the system attempted to generate and attach a newly created re-pick task to a pre-shipper.
- 18 Movement Conf. Workbench (80.8.4) now correctly updates the To Location, selected by the location find (LF) algorithm for PICK-SO tasks. The system updates the To Location when all of the following conditions apply:
  - You use Picklist/Pre-Shipper-Automatic (7.9.1).
  - You confirm the first system-generated PICK-SO task.
  - You set up a three-step routing for the same site and warehouse.
  - You set up wave planning in Wave Planning Control (80.15.23).
- 19 Unplanned Issue Request (80.17.13) now displays the correct available quantity when:
  - You set the remark field to No More.
  - The quantity of inventory you enter to be picked is more than the quantity available.
  - You set the Overissue inventory status to No and Overpick to Yes for the location from where quantity is picked in Transaction Type (80.7.6)

# Release Notes for Version 3.0.5

**Advanced Inventory Management Version:** 3.0.5 and SSD 3.0.5

**Release Date:** October 2009

**Compatibility for 3.0.5:** eB2, Initial release to Service Pack 13

**Compatibility for SSD 3.0.5:** eB2.1 SP2 to SP4; QAD 2007 and 2007.1; QAD 2008, 2008.1, and 2009 Standard Edition

**Note** AIM supports only the Progress database.

**Supported languages:** US English, Castilian Spanish, Dutch, French, German, Italian, Polish, Brazilian Portuguese, Japanese, Chinese, Traditional Chinese, Slovak, Latin Spanish, Czech, Lithuanian, and Russian

**User Guide:** *Advanced Inventory Management*, item 78-0650A

**Installation Guide:** *Advanced Inventory Management*, item 78-0649C

## Fixes for AIM 3.0.5

The following fixes and improvements were made in AIM 3.0.5:

- 1 General improvements and corrections were made, including:
  - Issues when confirming tasks on the RF were corrected.
  - The Cancel function (F4 key) now operates correctly on the RF, letting you properly exit programs.
  - RF functions now correctly clear the screen before starting a transaction confirmation.
  - RF locking issues were resolved.
  - RF Repick functionality now operates correctly with kits.
  - AIM now correctly calculates the due date for scheduled orders.
  - You can now repick for kanban replenishment tasks.
  - All functionality for overstock replenishment operations is implemented and available.
  - RF menus now reside under menu 80.26.
  - The domain clause was added to MFG/PRO tables for AIM programs in eB2.1.
  - AIM installation was improved for non-US English languages.
- 2 RF Next Task (1.1) now:
  - Picks up tasks in a sequence. Previously, tasks were picked up randomly for the same priority.
  - No longer gives Progress TranD errors or errors regarding runtime parameters when warehouse staff confirm cycle count tasks.
  - No longer displays inventory conflict errors and correctly merges received inventory into existing inventory with the same reference and status when users receive a PO for which there was a partial receipt and Keep from Status set is No in Internal Routing Maintenance (80.2.5).
- 3 RF Select Task (1.2):
  - Now recognizes the reference associated with the task when the keyboard is used to type the reference instead of using the arrow keys. Previously, the system did not recognize the reference.

- Now lets you access a task that is soft assigned to another user. Also, all issues were corrected when a user attempts to access a task started by another user.
  - No longer displays tasks locked by pre-shipper select task and RF batch picking operations. Previously, locked tasks appeared although users could not select them.
  - No longer displays transfer error messages when you transfer a pallet to a single item location and the pallet contains multiple lot numbers for the same item.
  - Now correctly displays the values in the Item and Lot/Serial fields and displays the complete value for the Reference field when transferring the item from one location to another. Previously, the value for Item and Lot/Serial displayed as blank and the value for Reference was displayed incorrectly.
  - No longer displays system error messages when Check Digit is set to Yes in Warehouse Maintenance (80.1), and the user transfers a pallet from one location to another location.
  - No longer displays transfer error messages when staff transfer pallets to a single item location and the pallet contains multiple lot numbers for the same item.
  - No longer transfers inventory to the destination location when users cancel the transaction using CTRL-C.
  - Now displays an `Inspection Pending` error and prevents transfer of pallets when an inventory inspection is invoked through Sample Inspection Maintenance (80.22.1).
- 4 RF Location Audit (1.4):**
- Now lets users exit by selecting the End function on Reference and Alternate-UM fields during a cycle count on an empty location. Previously, users could not exit the RF without a correct entry or using an abort function.
  - Now changes the status of an item status from Fail to Available when the cycle count is finished for a given item with a quantity equal to the quantity available. Previously, the status remained as Fail.
  - No longer lets users enter an invalid UM. Previously, when users entered a non-existing UM, the system created a transaction.
  - Now displays the `Period Closed` error message when users attempt to change the quantity when a GL calendar period is closed.
- 5 RF.PO Receipt (1.8):**
- Now deletes only the selected item and corresponding location detail record when the reference has multiple items. Previously, the system deleted the entire reference.
  - No longer locks records.
  - Now correctly displays the destination location frame in the first row when you use the put-away algorithm. Previously, the destination location frame was displayed incorrectly.
  - Now correctly displays the `Gen Shipper ID? Y/N` prompt when users specify a blank shipper ID. Previously, the system waited for user input without displaying a prompt.
- 6 RF.Reprint (2.2) now correctly reprints the transaction detail for a transaction number from Warehouse Transaction Inquiry (80.9.1) with Transaction Type set to I. Previously, the transaction details were printed incorrectly.**
- 7 Several improvements were made to RF Batch Pick-SO (3.1). The program:**
- Now validates the Quantity field and no longer moves to the next field when the user presses the up arrow.
  - No longer lets users press right or left arrow keys or hit the Enter key in the Item field.

- Now lets users change the To Lot/Serial value when the To Lot/Serial field is set to allow change in Internal Routing Maintenance (80.2.5). Previously, the system did not let users change the value in the field. This is also true for RF Batch Pick All (3.2).
  - Now correctly calculates the net weight and gross weight in the header and container level of the pre-shipper when you create the pre-shipper for an item with specified net weight, ship weight, or both. Previously, the values were calculated incorrectly.
  - Now correctly moves partial quantities from one container to another when users press the F7 key to invoke the move item function. The transferred quantity displays correctly in Pre-Shipper/Shipper Workbench (7.9.2).
  - Now correctly moves the inventory from a previous location to the next location when you set Two Phase to No in Internal Routing Maintenance (80.2.5) for the last sequence of the internal routing and the task is closed. This is also true for RF Batch Pick (3.2) and Movement Conf. Workbench (80.8.4).
  - Now correctly creates allocation details and does not delete the pre-shipper line when the system validates the transaction with a null quantity. Previously, the quantity picked was left in the user location.
  - No longer creates pick details for a user location with a zero quantity when the system validates the transaction with a null quantity and Complete, Repick, Fail set to Yes in the RF Batch Picking program (3.1.3.2). Previously, the system moved the zero quantity to the user location.
  - No longer creates a negative inventory balance for a location with an inventory status when you specify that overissue is allowed and attempt to confirm the pre-shipper after a cycle-count entry. Previously, the system created a negative inventory record.
  - Now correctly rolls back the transaction when users confirm the first pick task, then select the Undo and Leave function from any other pick task for items that have a To Reference set to automatically generate a new reference (option 5) in Internal Routing Maintenance (80.2.5).
  - Now updates the start date, time, and user ID when users press the End function after partially confirming the sales order quantity. Previously, the values were blank.
- 8** During RF.Containerization (3.3) functions, the system no longer locks records, and pre-shippers display correctly.
- 9** RF Container Move (3.4):
- No longer displays error messages, informing users that it cannot change location, and now correctly moves inventory to the destination location when multiple sequences of internal routing group are specified in Internal Routing Maintenance for a container move.
  - Now correctly creates and confirms a warehouse transaction and moves the inventory to the destination location when users change the destination location and an internal routing does not contain the storage location group of the destination location. Previously, the transaction was not created.
  - No longer fails when you use multi-item pallets.
- 10** Cycle Count Result Entry (3.14):
- No longer displays a locking error when users transfer the same item that was counted using the RF Transfer (1.3) option. Previously, the system locked at the Location prompt, waiting for user input for next Transfer.
  - Now displays an error, informing users that the quantity on hand was changed by another user with a PICK-SO transaction, created in another RF Batch Pick-SO (3.1)session. The error displays before users enter cycle count results. Previously, no error was displayed, and cycle count completed with incorrect quantities.

- 11 Pre-Shipper/Shipper Confirm (7.9.5) no longer creates ISS-FAS transactions with incorrect quantity when Kit component items are picked from multiple locations. Previously, the system created incorrect quantity for ISS-FAS transaction and left some quantity at the assembly location.
- 12 Repetitive Picklist Calculation (18.22.3.1) now rounds the transfer quantity to multiples of the quantity defined in Item Planning Maintenance (1.4.7) when you set Use Order Multiples to Yes for component items and when AIM is enabled.
- 13 Purchase Order Receipts (5.13.1):
  - Now correctly generates the next new reference (pallet) when you attempt to split a pallet. Previously, the reference was blank.
  - Now performs inspection and moves inventory from the receipt location to the inspection location when the system uses the QA algorithm and you set up algorithms for purchase order receipts in Algorithm Assignment Maintenance (80.6.9). Previously, inventory was not moved for an inspection.
  - Now correctly picks the inspection location defined in Whse Master List Maintenance (80.1.5) for an RCT-PO transaction and sets Multi-Entry to Yes to generate the pallet reference numbers when you set Inspection to Yes in Item Master Maintenance (1.4.1).
  - Now generates pallet references with correct quantities when the system uses UM conversions, and you set Receive All to Yes during the receipt. Previously, the system generated pallet references with incorrect quantities.
- 14 Transfer By Reference (80.17.1) no longer displays destination location errors when you use inter-warehouse transfer and have a value other than non-blank in the To Location. Previously, the error displayed and the system did not allow the transfer.
- 15 Item-Site Maintenance (80.4.9) now lets you delete the AIM record. Previously, the Delete function was disabled.
- 16 Movement Conf. Workbench (80.8.4):
  - No longer displays the Single Item location has existing inventory message when confirming a count task with a quantity of 0 (zero).
  - No longer lets you receive new items on a single-item location where other item inventory exists. Previously, you could receive new items on the single-item location.
  - No longer displays cancelled transactions. It also executes the necessary site-security validation for sites in the confirmation range.
- 17 UM Group Report (80.5.8) now only displays the UM group that is assigned to the item when you do not enter a UM Group range, but you specify an Item Range. Previously, the system displayed all UM Groups for all items.
- 18 Quality Inspection Control File (80.22.24) now displays and updates the Create Inspection Workfile Records? field. Previously, the field did not display.
- 19 Distributed Order Receipt (12.15.20) and Work Order Receipt (16.11) now move all pallet references to the end location when both programs operate simultaneously. Previously, the system moved some pallet references to the GIT location.
- 20 Purchase Order Receipts (5.13.1) now properly updates the Supplier Lot field when purchase order receipts are complete for AIM-controlled items with a pallet reference. Previously, the Supplier Lot field was not filled.
- 21 Task Re-assignment Maintenance (80.11.9.2):

- No longer lets you assign tasks to another user while a user is actively working on these tasks in RF Batch Pick-SO and displays an error if you try.
  - Now displays the reassignment tasks sorted by location and item number. Previously, the reassignment tasks were displayed randomly.
- 22** The system now correctly transfers quantity multiples, defined in Item Planning Maintenance (1.4.7), for component items when AIM is enabled and Use Order Multiples is Yes.
- 23** Replenishment List Maintenance (80.16.1) now allows CIM loading. Previously, CIM loading was disabled.
- 24** Pallet Constitution/Transfer (80.17.20):
- No longer prints the Identification Document when the Print ID flag is set to No. Previously, the system printed the Identification Document.
  - Now correctly returns control to the To Location field when the location does not exist and an error displays. Previously, control was returned to the Site field in first frame.
  - Now prints the confirmed task label only when you set Print ID to Yes or Print Confirmed Tasks to Yes in Internal Routing Maintenance. Previously, the system printed confirmed task labels.
- 25** External Routing Maintenance (4.2.13) now displays the description for an existing record when you modify an existing record without using the arrow keys. Previously, the system did not display the description.
- 26** Wave Replenishment (80.15.4) now correctly creates only one new pre-shipper for all sales orders with the same ship-to when New Preshipper by Wave is set to Yes in Wave Planning Control File (80.15.23).
- 27** Sales Order Manual Allocations (7.1.6), now deletes the AIM transaction when you delete the allocation line. Previously, the system did not delete the transaction.
- 28** Storage Location Group Maint. (80.3.1) now lets you view and modify all fields of the Storage Location Detail Frame at the same time. Previously, you had to press Go twice to modify and view the fields.
- 29** Pre-Shipper/Shipper Confirm (7.9.5) now shows an improved performance when confirming a pre-shipper with more than 30 lines. Previously, the performance was poor.
- 30** Order Detail Status Inquiry (80.15.9) no longer displays a Progress error when you select option P and displays the order detail lines when you select option D.
- 31** Movement Conf. Inquiry Format (80.8.6) now correctly transfers inventory during inter-warehouse transfer for multi-item pallets when you confirm the transaction created by Transfer By Reference (80.17.1). Previously, the system did not transfer inventory for a pallet item associated with a pallet in Alternate UM (80.5.1).
- 32** PO Shipper Maintenance (5.13.14) now creates references for a purchase order and correctly sets the Multi-Entry field to Yes. Previously, the system did not generate a reference and set Multi-Entry to No.
- 33** Wave Selection (80.15.1):
- Now automatically deselects the sales order lines when you toggle the Enter key to deselect a sales order).
  - Correctly sets the Include field of the sales order line to No when you press D (for details).

- Now selects any unallocated scheduled orders in the wave, regardless of how you set Display Only Allocated Lines in Wave Planning Control File (80.15.23). Previously, you could not select unallocated scheduled orders in Wave Selection when Display Only Allocated Lines flag was set to Yes in the control file.
- 34** Re-Balance Expected In/Out Qtys (80.24.21.15) no longer displays data for multi-lot items when there are no discrepancies in the From and To Location fields. Previously, the system displayed expected in and expected out quantities, even though there were no discrepancies.
  - 35** Sales Order Shipments (7.9.15) no longer updates the quantity to allocate and quantity picked for line items that are not shipped for a multi-line sales order when few lines have shipped, and AIM is enabled.
  - 36** Location Maintenance (80.3.13.1) now defaults the value of the OPC Frequency field in Storage Location Group Maint (80.3.1) that the system uses in the location. Previously, the system did not default the value from Storage Location Group.
  - 37** The system now correctly calculates the pre-shipper for tasks that do not belong to a wave.
  - 38** Sample Inspection Maintenance (80.22.1):
    - No longer displays the messages in French when you press the F1 key after entering input criteria.
    - Now correctly changes the inventory status of the location to available when you change the location, lot, or reference of non-inspected items for a receipt when confirming the transaction using any of the AIM or RF confirmation options.
    - Now has all inspection detail lines accessible for scrolling in the Polish environment.
  - 39** User-Work Location Group Maint (80.11.19.1), User Printer Maintenance (80.20.7), and User-Work Location Group Maint (80.19.5) now let you input data for the Inspection Printer and Use External fields.
  - 40** Warehouse Transaction Inquiry (80.9.1) now refreshes the Shipper ID field in the Other Details frame after you view transactions with a blank Shipper ID; then view transactions in a non-blank Shipper ID field. Previously, the system retained the non-blank shipper ID.
  - 41** Generalized Codes/Domain Utility (80.24.21.4) now generates a report showing newly created and existing generalized code records. You can now run the program in simulation mode even though an actual update does not occur. Previously, a Progress error displayed in this scenario.
  - 42** Movement Conf. By Transaction (80.8.1):
    - No longer creates negative inventory for a location when confirming a PICK-WO task after a cycle recount entry when you set Overissue to No. Previously, a negative inventory record was created.
    - Now correctly creates the new pre-shipper line for the shipped quantity when the quantity shipped is less than the original transaction quantity to be picked and you set Complete to No, Fail to No, and Repick to Yes.
  - 43** Unplanned Issue Request (80.17.13) now correctly updates the quantity to pick and sets the Remark field to No More when:
    - The entered quantity to pick is more than the quantity available and inventory status of the location from where quantity is picked.
    - Overissue set to No.
    - More than one algorithm is assigned for the algorithm type

- 44 Wave Release (80.15.5) now successfully launches the wave for an item that has an existing wave replenishment task, and you set Avoid Release Without Replenish to No in Wave Planning Control (80.15.23). Previously, the system did not release the wave.
  - Location Maintenance (80.3.13.1) now correctly calculates the capacity of a location when multiple receipts are done by all put-way algorithms. Previously, the capacity was calculated incorrectly.
- 45 Wave Status Inquiry (80.15.2) now correctly displays the total task count for reserve, replenishment, and pick tasks, when you delete an unconfirmed pre-shipper that has an open AIM task and release the wave using Wave Release (80.15.5). Previously, the total task count was displayed.
- 46 Location Report (80.3.13.3) now correctly displays the value in the Location %Full field for the original To Location when you change the To location in Movement Confirmation Workbench to a different location for a stock transfer transaction.
- 47 Transactions by Item Report (3.21.14) now correctly displays the end balance for an RCT-TR transaction when the system transfers an item from one location to another within the same site, using Transfer With Lot/Serial Change (3.4.3). Previously, the end balance was displayed incorrectly.
- 48 Distrib Order Picking Print (12.17.19) no longer displays an error message and creates the picking task correctly when you specify only algorithm 3 (Merge with Same Order) as the Location Find algorithm type in Algorithm Assignment Maintenance (80.6.9) and you use a single location.
- 49 Bulk Pick Selection Approval (80.12.12) now creates transactions for all component items when some of the component items are not defined in Item Warehouse Maintenance (80.4.11). Previously, the system did not create the transactions for the component items that were not defined in Item Warehouse Maintenance (80.4.11).
- 50 Transactions Detail Inquiry (3.21.1) now correctly displays the effective date for the issue and receipts transactions for an AIM item with a defined internal routing when you enter an effective date other than system date in Receipts Unplanned (3.9). Previously, the system displayed the effective date incorrectly as the system date.
- 51 Generate Receipt Forecasts (80.10.1) now recalculates the location forecast when you modify the requirement in Purchase Order Maintenance (5.7), Work Order Maintenance (16.1), or Distribution Order Maintenance (12.17.14). Previously, the location forecast was not changed.
- 52 Inspection History Maintenance (80.22.17) now displays the correct values for Quantity to Inspect and Return Quantity fields when you pass a sample or reject an inspection. Previously, the system displayed incorrect values.
- 53 Pre-Shipper/Shipper Workbench (7.9.2) no longer lets you delete the entire pre-shipper or any of the pre-shipper lines when there is a linked RF task executing simultaneously in RF Batch Pick (3.1). Previously, you could delete all or portions of the pre-shipper under these circumstances.
- 54 Location Maintenance (80.3.13) now correctly calculates the capacity of a location when multiple receipts are done by all put-way algorithms. Previously, the system calculated capacity incorrectly.
- 55 Algorithm Assignment Report (80.6.11) now displays the custom algorithm and program name if you assigned a custom algorithm in Algorithm Assignment Maintenance (80.6.9). Previously, the report output was blank.
- 56 Replenishment Request (80.16.5) now displays all inventory available to replenish. Previously, the system display only pallet inventory available to replenish.
- 57 Work Order Receipt (16.11) now moves the inventory to the correct destination location and creates a short SO transaction history per the number of sequences defined in Internal Routing Maintenance when you set Two Phase to No for the shortage internal routing.

- 58** Picklist/Pre-Shipper - Automatic (7.9.1) now correctly picks up the inventory by last in first out (LIFO) picking for locations with LIFO picking type when inventory details for the inventory available for picking changes in the reverse order from which the inventory was moved into the location.
- 59** PA/LF Simulation (80.6.21.1) now selects a proper location when you simulate a put-away algorithm for an end item and enter a lot/serial for which there is no existing inventory, but a location exists with inventory in another lot/serial for the item.
- 60** Distribution Order Shipments (12.17.22) no longer creates a new reference with a negative quantity when you set the original reference to blank during RF Container Move (3.4) operations and you change the quantity picked. Previously, the system created a new reference.
- 61** Purchase Order Returns (5.13.7) no longer resets Multi-Entry to No when you set the field to Yes manually after entering data in the Reason field.
- 62** The system no longer leaves incorrect modified values in records in Movement Confirmation Workbench (4.8.7) when you attempt to modify a transaction, then press the Cancel function.

# Release Notes for Version 3.0.4

**Advanced Inventory Management Version:** 3.0.4 and SSD 3.0.4

**Release Date:** March 2008

**Compatibility for 3.0.4:** eB2, Service Pack 12

**Compatibility for SSD 3.0.4:** QAD Enterprise Applications 2008 - Standard Edition

**Note** This release supports only the service packs listed. For AIM support for earlier eB, eB2, or eB2.1 service packs, contact your QAD customer service representative.

**Supported languages:** US English, Castilian Spanish, Dutch, French, German, Italian, Polish, Brazilian Portuguese, Japanese, Chinese, Traditional Chinese, Slovak, Latin Spanish, Czech, Lithuanian, and Russian

**User Guide:** *Advanced Inventory Management*, item 78-0650A

**Installation Guide:** *Advanced Inventory Management*, item 78-0649B

## Fixes for AIM 3.0.4 and AIM SSD 3.0.4

This release includes performance improvements in AIM, elimination of compile errors for some languages in AIM, and fixes for both the Radio Frequency (RF) and system versions of AIM. In addition to performance improvements, the following fixes were made:

- 1 Receipt Unplanned (3.9) now correctly considers storage location groups (SLGs) in alphabetical order if more than one SLG for storage and algorithm type is LF (Location Find). Previously, SLGs were not considered in alphabetical order. Also, Receipts-Unplanned are correctly formatted for .NET UI.
- 2 Purchase Order Receipts (5.13.1) now correctly creates tasks for inventory movement from receipt to storage if you specify that the SLG associated with the receipt location is receipt only in Storage Location Group Maint (80.3.1).
- 3 Sales Order Manual Allocations (7.1.6) now displays the following error message when there is an internal transaction from the same location:  
`Qty allocated would exceed qty available at this location`  
Previously, the system allocated inventory and did not display an error message.
- 4 Sequence Pre-Shipper - Automatic (7.5.4.10) no longer locks the Number Range Master table (nr\_mstr) when inventory movement codes and shipping groups are defined with unique number range sequences for pre-shippers and shippers. Previously, the system displayed an error message and prompted you to either wait or end the AIM session.
- 5 Sales Quote Maintenance (7.12.1) now lets you process orders while entering a sales quote for kit items and no longer displays the following Progress error:  
`No so_mstr record available`
- 6 Work Order Receipt (16.11) now considers the alternate unit of measure (UM) defined in Unit of Measure Maintenance (1.13) when receiving a work order with a negative quantity. Previously, the system assigned a blank alternate UM when receiving negative inventory.
- 7 Item Master Maintenance (80.4.5) no longer locks the Item Master Shadow table (ptmstrS) after you cancel. Previously, when you cancelled, the system displayed a message indicating the table was in use and prompted you to either wait or end the AIM session.

- 8 Movement Conf. By Transaction (80.8.1) now correctly updates the quantity expected in the transaction detail table when confirming a transaction. Previously, the system did not correctly update the quantity expected.
- 9 Movement Conf. WorkBench (80.8.4) now displays a maximum of 11 digits including decimals in the Expected, Actual, and Confirmation Quantity fields. It also creates correct transfers while modifying a movement task created in Transfer Single Item (80.17.4) with quantities that have 11 decimals including the decimal places.
- 10 Percentage Full By Store Loc Gp (80.9.17) no longer displays different data in two different QAD ERP applications. Previously, when the location was changed during task confirmation using the RF Task Confirmation (1.2) option, the system displayed different data in two different QAD ERP applications.
- 11 Wave Replenishment (80.15.4) now correctly generates replenishment tasks for a wave with distribution orders. Previously, replenishment tasks were not generated for waves with distribution orders.
- 12 Order Detail Status Inquiry (80.15.9) displays pre-shippers faster. Previously, performance was slow. It also no longer displays the error message:  
Unable to understand after - OrderMTT.Database
- 13 Replenishment-SLG Maintenance (80.16.17) now lets you define a replenishment SLG with a date range and no longer displays the following warning message:  
WARNING: Date ranges may not overlap.  
It also lets you create a replenishment-SLG for a warehouse within the same site.
- 14 Transfer By Reference (80.17.1) now correctly creates AIM transactions and no longer generates the following error message in Computer Integrated Manufacturing (CIM):  
ERROR: Reference does not exist  
Previously, AIM transactions were not created for the transfer and error messages were output to a file.
- 15 Transfer Single Item (80.17.4) now displays the following message and prompt if the system transfers to a location defined with a capacity of 99999.9999:  
Only # will be moved. OK to Confirm ?  
Where # is the quantity to transfer.  
Additionally, the system now correctly calculates the location full percentage if the alternate UM conversion is defined in decimals and the capacity for the location is defined in pallet conversions.
- 16 Pallet Constitution/Transfer (80.17.20) now displays the following error message when creating a pallet for the item stocked in a location that has a consigned quantity:  
Consigned Inventory exists in the transfer qty for item #. Please re-enter.  
Previously, it allowed to you to create a pallet when the pallet quantity was a consigned quantity.
- 17 AIM no longer creates inspection workfile records, regardless of whether inspections were performed. The new Create Inspection Workfile Records? field was added to the Quality Inspection Control File (80.22.24) so that users can specify when AIM creates inspection workfile records. Set the field to No to prevent the system from creating inspection workfile records.
- 18 The AIM whwave08.p internal program now compiles properly in all environments. Previously, compiles failed because the system incorrectly wrote the table prefix.
- 19 The RF Next Task (1.1) option includes the following fixes:
  - a Correctly updates the inventory status only after confirming repick tasks. Previously, the system updated the FAIL status to a location status once a repick task was confirmed.

- b** Correctly changes the task label when switching tasks. Previously, the system did not change task labels when switching tasks.
- c** No longer displays the `Invalid Detail Ref` error message and lets warehouse users confirm the task when they use system flavor B, use stage-out locations, and set TO Reference field to 1. Previously, the system displayed an error message and did not let warehouse users confirm the task.

**Note** You set system flavor codes in Generalized Code Maintenance (36.2.13 or 80.24.21.1). The codes relate to display of information in situations such as fork-lift truck screens or RFs.

- 20** RF Next Task and Select Task (1.2) now correctly confirm picking tasks created for work orders with system flavor B when there are two location detail records with the same reference for different parts. Previously, the system displayed an error message in this scenario.
- 21** The RF Transfer (1.3) option now rolls back transactions when the user cancels prior to completing the task. Previously, when users cancelled, transactions were not rolled back and the system created OTF-TR transactions for movement tasks.
- 22** The RF Preship Sel Task (1.7) option no longer lets warehouse users switch tasks between two pre-shippers. Previously, the system let users switch tasks between two pre-shippers.
- 23** The RF PO Receipt (1.8) option now runs if warehouse users select it from the Work (1.) menu. Also, RF PO Receipt now deletes both the reference and item when users press 3 at the reference level. Previously, warehouse users had to delete the reference separately after deleting the item within the reference.
- 24** The RF Stock Inquiry (1.9) option now displays eight characters for the Loc(ation). Previously, only seven characters displayed.
- 25** The RF Batch Pick-SO (3.1) option now:
  - a** Correctly calculates net weight and gross weight for a pre-shipper at the pre-shipper header level when you use a container and the pick task fails. Previously, the system incorrectly calculated net and gross weight under these conditions.
  - b** Creates repick tasks for the same wave when warehouse users repick for a pre-shipper from the wave. Previously, the system created repick tasks for a pre-shipper in a different wave.
  - c** Correctly displays the movement task to the same dispatch location while confirming a repick task. Previously, the system displayed the next dispatch location while confirming a repick task.
  - d** Correctly validates the container number when warehouse users press F6 to drop all. Also, the option no longer displays an error message if a container with container ID 0 exists. Previously, it incorrectly validated the container number and displayed an error message.
  - e** No longer lets warehouse users enter a negative quantity when batch picking a sales order and displays an `Invalid Qty` error message when warehouse users enter a negative quantity:
- 26** The RF Container Build (3.3) option no longer lets users add a box to a different container if the box has been shipped and confirmed.
- 27** A new AIM `-rereadnolock` startup script parameter prevents the system from incorrectly displaying the quantity on hand when warehouse users perform a cycle count, then recount the quantity from the RF device. Previously, the system did not display the correct adjusted quantity of an item if users previously viewed item data through an inquiry program.

# Release Notes for Version 3.0.3 and SSD 3.0.3

**Advanced Inventory Management Version:** 3.0.3 and SSD 3.0.3

**Release Date:**September 2007

**MFG/PRO Compatibility for 3.0.3:** eB, initial release through Service Pack 9

eB2, initial release through Service Pack 12

**MFG/PRO Compatibility for SSD 3.0.3:** eB2.1, Service Packs 2 through 6 (QAD 2007.1)

**Supported languages:** US English, Castilian Spanish, Dutch, French, German, Italian, Polish, Brazilian Portuguese, Japanese, Chinese, Traditional Chinese, Slovak, Latin Spanish, Czech, Lithuanian, and Russian

**User Guide:** *Advanced Inventory Management*, item 78-0650A

**Installation Guide:** *Advanced Inventory Management*, item 78-0649B

## Fixes for AIM 3.0.3 and AIM SSD 3.0.3

This release includes performance improvements to AIM, particularly when AIM processes large distributed orders. In addition to performance improvements, the following fixes were made:

- 1 AIM now correctly runs with European Accounting.
- 2 AIM now updates the pre-shipper for the items in the wave with the Radio Frequency (RF) device's To Location value if you specify a value. If no value exists in the field, the system updates the pre-shipper with the RF From Location code. The To Location and From Location fields display on the RF during batch picking for a wave.
- 3 The system no longer sets the Reference field to blank when you transfer a distributed order (DO) in Distributed Order Receipts (12.15.20) with a negative quantity in an intersite transfer between two sites.
- 4 Indexing problems were corrected and batch picking performance has been improved.
- 5 Supplier-Item Browse (80.4.14) now displays data without errors.
- 6 Location quantities are now correct when you transfer items to multiple locations using the RF device. Previously, when you transferred items with on-the-fly transactions (OTF-TR) on the RF, the system moved stock from the first transaction's destination, rather than from the original destination.
- 7 AIM now correctly updates the inventory quantity on hand when you perform an AIM inter-warehouse transfer between warehouses that belong to two different sites.
- 8 Replenishment Request (80.16.5) now proposes correct replenishment transactions when you set Create Transactions to No. Since the system does not update location details, if you did not fully fill a location with a prior transaction, previously, the system proposed another replenishment request regardless of how you set the Create Transactions field. Now the system keeps track of the full percentage at run time, so the system does not present additional transactions to you when you set Create Transactions to No.
- 9 The system now clears the screen and no longer displays a message that the automatic replenishment started during an on-the-fly transfer from the RF device. Instead of the message, the system now correctly displays the transfer start screen.

- 10 Pallet Constitution/Transfer (80.17.20) now correctly checks for existing references and checks whether the reference is correct for the unique level for the reference you define in the Reference Uniqueness Level field in Warehouse Management Control (80.24).
- 11 Pre-Shipper/Shipper Confirm (7.9.5) no longer displays missing widget error messages while using the AIM containerization functions.
- 12 The system no longer displays Progress errors on the RF device during detail picking for a pre-shipper. You can now correctly access the pre-shipper or sales order details without the error message.
- 13 The system now correctly displays the reference number during a return put-way. Previously, the system left the reference blank during a return.
- 14 RF Preship Select Task (1.7) now correctly sorts pre-shippers.
- 15 RF Batch Picking (3.3) now correctly generates a cycle count task for a failed location. You can fail a location on the RF once the picking task is complete if you:
  - Specify a Repick Option in Warehouse Maintenance (80.1.1).
  - Enter a quantity of 0 (zero) for the location.Normally, the system initiates the repick option when you enter a quantity in a location that is lower than the task quantity, but entering 0 causes the system to generate a cycle count.
- 16 Errors no longer occur in batch picking when transferring inventory to a pre-defined user location, such as the picking cart.
- 17 AIM now correctly creates a sample at the specified inspection frequency for a receipt when you use the QA algorithm. The QA algorithm is algorithm number 9—inspection of items for every specified number of receipts. AIM normally compares the actual receipt with the last inspection. The QA algorithm, however, counts the number of receipts for that item, then finds the last sample created based on the transaction history to do the comparison. So, the algorithm now correctly looks at the number of receipts to initiate the inspection rather than the time of the last inspection.
- 18 Storage Location Group Maintenance (80.3.1) now correctly displays a warning message when you enter a storage location group that is not defined in the system in the Detail Overflow Group field.
- 19 Allocated Inventory Inquiry (3.18) now correctly displays both allocated and unallocated quantities when:
  - A work order is released.
  - A larger quantity is confirmed in Movement Conf. Workbench (80.8.4).
  - The original quantity for the component is issued.Previously, quantities displayed incorrectly with these conditions.
- 20 The RF function to move items between boxes has been improved. You can find an item to be moved in one box more efficiently than before.
- 21 Hold Inquiry (80.3.22.2) no longer displays a Progress error if the From Date field is blank in Hold Maintenance (80.3.22.1). Also, Hold Inquiry now correctly refreshes records.
- 22 Storage Location Group Maintenance (80.3.1) now defaults the correct value for the following fields from Warehouse Maintenance (80.1.1):
  - Count Status Option
  - Opportunity Counts
  - POC Frequency
  - Check Digits

- 23 The RF device now correctly displays the last current picking task of the user after the device crashes. This lets the user easily continue with batch picking tasks after RF service interruption.
- 24 Sample Inspection Maintenance (80.22.1) now correctly updates return quantities when warehouse staff only return a portion of the total quantity to inspect.
- 25 Repetitive Picklist Undo (18.22.38) and Repetitive Picklist Delete (18.22.3.9) now correctly delete AIM tasks. Previously, the system did not delete AIM tasks even though allocations displayed correctly in Inventory Detail Inquiry (80.8.17).
- 26 Movement Conf. Workbench (80.8.4) no longer changes the confirmed quantity when you change the quantity for a transaction and Allow Quantity Increase or Allow Quantity Decrease is set to No in Internal Routing Maintenance (80.8.4).
- 27 Available Kit Quantity to Ship (7.1.8) now correctly creates records for detail allocation for the components of kits.
- Available Kit Quantity to Ship determines the component of the kit with the least quantity available to allocate; it then creates detail allocations for this quantity for all kit components. Because AIM functions already pick the available kit components, the system previously created double allocations and incorrectly displayed status and quantities in Allocated Inventory Inquiry (3.18).
- 28 RF Pre-Ship Select Task (1.7) now correctly displays priority across movement tasks when you set the Stage In and Stage Out locations and change the priority for a pre-shipper. The Stage In and Stage Out fields in Warehouse Location Maintenance (4.3.13) identify whether a location is staged. If both fields are blank, the location is not staged.
- 29 Item Number Change (1.4.1) no longer displays errors when an AIM part number with stock is changed to another part number. Also, stock within MFG/PRO and AIM tables is now correctly updated.
- 30 Progress errors related to mismatched number of parameters no longer display while running Wave Replenishment (80.15.4) and Wave Release (80.15.5).
- 31 Sample Inspection Maintenance (80.22.1) now correctly displays quantities in the Qty to Inspect and Receipt Qty fields when the quantity to inspect is more than five digits to the left of the decimal place.
- 32 RF PO Receipt (1.8) now correctly displays values in the Qty Order field and no longer displays a Progress error while receiving a purchase order that has more than four digits for the order quantity. The program also now locks the Purchase Order Control table when generating receiver numbers, then releases the lock before put-away shipper processing. By locking the table until it generates the receiver number, two users can receive the same shipper simultaneously with two unique receiver numbers and continue processing.
- Note** Two users can only receive the same shipper when Receiver Type is set to 2 in Purchase Order Control (5.24).
- Additionally, RF PO Receipt now deletes location detail records when RF users enter the wrong purchase order receipt record, then delete it.
- Also, inspections in AIM now record the put-away task in Inventory Detail Inquiry (80.9.13) upon purchase order receipt.
- 33 RF users can now access records without receiving locked-record errors when AIM users use Transfer by Reference (80.17.1) and Logistic Palletization/Transfer (80.17.17). Previously, when RF users attempted to access records, particularly after a transaction, and these AIM programs were in use, the system displayed locked-record messages.

- 34** Order Detail Inquiry (80.15.9) now correctly displays the distribution orders for a ship-to and carrier when you select S(hipper) on a distribution order. Previously, the system displayed the distribution orders without ship-to and carrier data.
- 35** UM Conversion Generation (80.5.9) now correctly updates input values to data fields while reporting data to MFG/PRO batch processes. Previously, the system updated some data with blank values.
- 36** RF Batch Pick-SO (3.1) has improved performance for sales orders with multiple lines and when the SO Batch Selection field in Batch Picking Control (80.15.24) is set to Customer. In addition to improved performance, the program:
- No longer locks when two RF users batch pick different sales orders for the same item.
  - Correctly prioritizes the tasks with higher priority when you repick items and set the priority for a repick task at the highest level in Internal Routing Maintenance (80.2.5).
  - No longer locks TranD records and does not display TranD error messages while AIM users run Picklist/Pre-Shipper Automatic (7.9.1).
  - Accepts decimal values while processing a sales order without displaying errors when you enter a decimal as the quantity shipped.
  - No longer displays errors for consigned sales orders.
- 37** Movement Conf. By Transaction (80.8.1) no longer displays error messages about mismatched passed parameters.
- 38** AIM now fully operates with Progress OpenEdge 10. In previous releases, QAD explored the possibility of adding the `-k` parameter to the client scripts to prevent the usage of the Progress `dataset` keyword so that AIM code compiled correctly; however, this solution did not work well while using QXtend with AIM and implementing `proDataSets`. By changing all references to the Progress `dataset` keyword, this limitation is now fixed. However, while building the AIM database, it is still necessary to use the `-k` parameter to deactivate the `dataset` keyword. See “Configuring MFG/UTIL for OE10” on page 24.
- 39** RF Transfer (1.3) now correctly presents the destination location if you cancel a transfer for a destination location with a capacity of two pallets, then transfer items to a location that has a capacity percentage less than 100% full. Previously, the system did not present the correct destination location for the transfer location.
- 40** The Free field in the To frame of Optimization Transfer (80.17.12) now correctly displays the percentage of capacity free for the destination location.
- 41** RF Item Move (3.7) no longer displays errors for an item number with a length of 18 characters. Also, the program now displays item descriptions when you use the up/down arrow keys to select items. Previously, the system displayed invalid-part errors with items of 18 characters, and item descriptions did not display.
- 42** AIM tasks are no longer deleted when the requirement for a lot/reference is deleted in Work Order Bill Maintenance (16.13.1). Further, the task now displays in Movement Conf. Workbench (80.8.4) when you delete the requirement for a lot/reference.
- 43** RF Kanban Scan (1.1.5) now:
- Correctly displays the default kanban quantity and unit of measure (UM) for items.
  - No longer displays errors when RF users change the reference to be picked to another reference.
  - Lets you use the cancel button (F4) to quit the program.

- 44** Picklist/Pre-Shipper-Automatic (7.9.1) no longer displays errors when you generate a pre-shipper for sales orders that have Partial OK set to Yes in Sales Order Maintenance (7.1.1). Also, Pre-Shipper/Shipper Inquiry (7.9.3) now correctly displays the sales orders with Partial OK set to Yes for the pre-shipper.
- When Partial OK is Yes, the system prints a packing list and lets you make shipments when the entire quantity is not available. When Partial OK is No, the system checks that all line items are available for shipping before printing a packing list. If they are not, you cannot print a packing list for the order.
- 45** Work Order Operation Backflush (16.19) now correctly creates multiple pallets when you update the backflush with a quantity that contains more than one pallet. Previously, the system did not create the pallets.
- 46** RF Preship Sel. Task (1.7) now correctly displays sales order pick tasks when you assign the logged-in RF user to this task in User Warehouse Data Maintenance (4.11.3.1).
- 47** Wave Release (80.15.5) now correctly generates the pre-shipper when you set New PreShipper by Wave to No in Wave Planning Control (80.15.23).
- 48** The AIM put-away transaction now correctly updates the location full percentage and displays an error instead of a warning for proposed put-away transactions to a 100% full location.
- 49** RF Container Move (3.4) no longer leaves detail quantities in the shipping lane and quantity on hand in the truck when you process inventory with lot numbers after batch picking for a distributed order.
- 50** Labor Management Workbench (80.11.20) now correctly displays priority values in the Priority field if the value is greater than three digits.
- 51** Programs in the Location Forecast Menu (80.10) now correctly process receipts for the locations you forecast.
- 52** EAN/SCC Coding Test (80.19.13) no longer displays error messages for mismatched number of parameters passed when it completes a test for an EAN/UCC 128 program.
- 53** Transfer-Single Item (3.4.1) now correctly updates transaction beginning quantity on hand when the:
- Inventory transfers occur in the same site.
  - Status of the new location is the same as the old location within AIM.
- Previously, transaction beginning quantity on hand was incorrectly calculated in this situation.
- 54** Distribution Order Receipt (12.15.20) now correctly updates the item reference and deletes the location detail record for intransit locations while reprocessing a distribution order with positive and negative shipments for two sites.
- 55** Item Master Maintenance (80.4.5) now forces unique entries for the Barcode1 and Barcode2 fields. Previously, the system let identical barcodes for different items exist or let Barcode1 and Barcode2 codes exist for the same item.
- 56** The `Press Space Bar` message no longer displays after you log onto the RF device.
- 57** The system now correctly finds customer schedules and calculates shortage clearances for both customer schedules and customer sequenced schedules. Previously, AIM shortage clearance algorithms could not calculate open quantities on customer schedules.
- 58** RF On-Line SO Pick (1.10) now lets you enter 18 characters in the Item field, not 14 characters.
- 59** The system no longer checks the RF user location during replenishment for batch picking when you select an option for the Release Orders field in Batch Picking Control (80.15.24).

- 60 RF Move Item (3.7) now correctly sets the quantity picked to the preshipper line quantity when you move the item to a different container.
- 61 Transfer Single Item (80.17.4) now displays a locked-file message when you attempt to transfer items to a specified location and that location is being modified by another user in Location Maintenance (80.3.13.1).

## Installation

Use the information in *Installation Guide: Advanced Inventory Management* (item 78-0649B) to install Advanced Inventory Management, version 3.0.3.

In the installation guide, the section entitled, *Configuring Startup for OE10*, is no longer applicable. Other sections in the guide are replaced with information in the following sections:

## Installation Requirements

### MFG/PRO Requirements

AIM 3.0.3 can be installed with the following MFG/PRO versions on a Progress database; Oracle is not currently supported:

- MFG/PRO eB, initial release through Service Pack 9
- MFG/PRO eB2, initial release through Service Pack 12

AIM 3.0.3 SSD (Shared Services Domain) can be installed with:

- MFG/PRO eB2.1, Service Packs 2 through 6 (QAD Enterprise Applications 2007.1)

### Progress Requirements

AIM 3.0.3 can be used with the same versions of Progress supported by MFG/PRO including Progress 9.1D, 9.1E, OpenEdge (OE) 10.1A, OE 10.0B, and OE 10.1B.

## AIM Deployment

The recommended deployment of AIM on your server is to place the AIM directory structure (*AIMInstallDir*) parallel to the directory where you installed MFG/PRO (*MFGPROInstallDir*). On MFG/PRO eB2 on Windows, for example, if *MFGPROInstallDir* is `/dr01/mfgpro/eb2sp5`, *AIMInstallDir* would be `/dr01/mfgpro/aim30`.

## Languages

AIM supports the English (US), Dutch (DU), French (FR), German (GE), Castilian Spanish (CS), Brazilian Portuguese (BP), Italian (IT), Slovak (SK), Chinese (CH), Traditional Chinese (TW), Japanese (JP), Polish (PL), Latin Spanish (LS), Lithuanian (LT), Czech (CZ), and Russian (RU) languages.

## Configuring MFG/UTIL for OE10

If you are using Progress OpenEdge 10, you must complete these steps to add another parameter to the standard MFG/UTIL script. This additional step is required to prevent any incompatibility error generated by the use of a Progress reserved word in the AIM database. When you have completed this step, the Progress keyword dataset will be ignored by MFG/UTIL.

Unlike previous versions of AIM, this additional step is just needed when the schema for the AIM database is loaded. Once the AIM database has been created, ECOs Q13B and Q17C have modified the AIM code so that no reference to the keyword dataset exists. This allows AIM to fully support OE10 without any restriction.

- 1 Using an editor such as Notepad or vi, create a plain text file containing the word dataset. For example:

```
$ vi ignore.lst  
dataset
```

- 2 Modify your MFG/UTIL startup script by adding the following parameter to the database connection:

```
-k ignore.lst
```

For example:

```
# execute mfgutil.p  
cd /usr/qad/mfgpro/eB2.1SP4  
$DLC/bin/_progres -p /usr/qad/mfgpro/eB2.1SP4/xmfgusrc/mfgutil.p -c 500 -s 128 -D 50 -TM 31 -  
TB 31 -B 1000 -yy 1920 -d mdy -k /usr/qad/mfgpro/eB2.1SP4/ignore.lst -ininame mfguprog.ini
```

- 3 Save the file.

**Important** With AIM 3.0.3, it is no longer necessary to modify the client execution script for AIM to instruct the system to ignore the dataset keyword.

## Release Notes for Version 3.0.2 and SSD 3.0.2

**Advanced Inventory Management Version:** 3.0.2 and SSD 3.0.2

**MFG/PRO Compatibility for 3.0.2:** eB, initial release through Service Pack 9

eB2, initial release through Service Pack 12

**MFG/PRO Compatibility for SSD 3.0.2:** eB2.1, Service Packs 2 through 5

**Supported languages:** US English, Castilian Spanish, Dutch, French, German, Italian, Polish, Brazilian Portuguese, Japanese, Chinese, Traditional Chinese, Slovak

**User Guide:** *Advanced Inventory Management*, item 78-0650A

**Installation Guide:** *Advanced Inventory Management*, item 78-0649A

### Fixes for AIM 3.0.2 and AIM SSD 3.0.2

- 1 AIM now correctly references the shipper—not the pre-shipper—when the system creates a pick task while converting a shipper to a pre-shipper in Pre-Shipper/Shipper Workbench (7.9.2). AIM now correctly displays the shipper in Warehouse Transaction Inquiry (80.9.1).
- 2 The system now creates multiple references using AIM upon receipt of serialized items in the following programs:
  - Purchase Order Receipts (5.13.1)
  - Work Order Receipt (16.11)
  - Work Order Receipt Backflush (16.12)
  - Work Order Operation Backflush (16.19)
  - Receipts-Unplanned (3.9)
- 3 Logistic Palletization/Transfer (80.17.17) no longer generates an extra pallet; it now generates the correct number of pallets.  
Also, the program now checks the status of inventory transactions and based on the Overissue field in Inventory Status Code Maintenance (1.1.1) determines the overissue policy applied to a corresponding inventory transfer.
- 4 AIM now correctly updates the Storage Location Group (SLocGp) Description field in Storage Location Group Maintenance (80.3.1) with the correct value when you press Go.
- 5 Sample Inspection Maintenance (80.22.1) now updates the status of the source location. This is the inspection location for items that have not passed inspection.
- 6 The setting of the Allow Task Switching field in Work Location Group Maintenance (80.3.9) no longer conflicts with the ability to set several AIM destination location fields. Previously, if you set Allow Task Switching to Yes, you could not change the value of the destination location. Also, the Work Location Group Maintenance (80.1.1) setting of Allow Task Switching now correctly overrides the Warehouse Maintenance (80.1.24) and the Warehouse Control File Maintenance (80.1.24) setting of the Allow Task Switching field.
- 7 AIM inspections now create one transaction (INSPH) for one sample entering the inspection location when staff perform a sample inspection on multiple pallets in Sample Inspection Maintenance (80.22.1). This lets AIM now properly release the sample to the original location and create the correct transaction with the correct status. Previously, only the inventory status of the last pallet was correct.

- 8 AIM now checks the Allow field in Customer-Item Status Maint (80.4.17) for sales order shortage (SHRT-SO) inventory transactions; previously, it only checked the Allow field for a sales order pick (PICK-SO) inventory transaction.
- 9 Picked quantities are no longer wrong when you confirm a transaction more than one time—for example, when you change the lot—in Movement Conf. Workbench (80.4.4). The Input Matches No Record message no longer displays.
- 10 AIM now splits the quantity received in Purchase Order Receipt (5.1.13) into the correct number of pallets based on the UM conversion when you specify to receive all.
- 11 Allocation is now correct when you create bulk pick orders in Bulk Picking Approval (80.12.12) when detail allocations without tasks exist.
- 12 The system now deletes AIM tasks when you confirm a shipper, then delete the shipper.
- 13 The Generate Hold field now works when set to Yes in Movement Conf. by Order (80.8.3).
- 14 Picked and allocated quantities are no longer wrong in a sales order pick transaction (PICK-SO) when batch picking. When AIM creates a batch picking transaction with the To Reference different from the Reference, AIM now correctly updates the Location Allocation Detail (lad\_det) table and the ASN/BOL/Shipper Master (abs\_mstr) table.
- 15 You can now correctly print more than one identification label when you receive items if you set Print ID to Yes and ID Quantity to more than 1 in Item-Warehouse Maintenance (80.4.11).
- 16 You can now enter a location size quantity larger than 99999 when you specify the UM as R (Reference) in Location Maintenance (80.3.13.1). The quantity now displays correctly on reports.
- 17 The system now considers the inspection lead time when you:
  - Set Inspec Req to No in Purchase Order Maintenance (5.7).
  - Set the Inspect field to Yes in Item Master Maintenance (1.4.1).
  - Specify an inspection lead time in the Ins LT field in Item Master Maintenance (1.4.1).

Also, the system now uses the location you specify in the warehouse master list in AIM rather than the location you specify in Purchasing Control (5.24) for the purchase order when you specify inspection lead time.
- 18 AIM no longer cancels transactions when you close a work order in Work Order Maintenance (16.1) and Work Order Receipt (16.11). Now, after you receive the work order that creates the transactions, you can close the work order and AIM does not cancel the pending transactions.
- 19 The system now correctly completes transactions and correctly updates the pre-shipper/shipper when warehouse staff batch pick less than the expected quantity to two or more different containers.
 

Also, the system now correctly checks the internal routing for more steps when warehouse staff batch pick less than the expected quantity. You can now correctly define the movement as an internal routing with three steps in Internal Routing Maintenance (80.2.5). So, if staff pick less than the expected quantity, the Completion Option in Warehouse Maintenance (80.1.1) is set to an option that does not close tasks, and there is a three-step internal routing defined, AIM correctly creates new tasks for the remaining items to be picked.
- 20 AIM now correctly updates inventory and correctly creates recounts when the quantity is out of the range of tolerance during an RF Location Audit (1.4).
- 21 You can now reprint from the RF Reprint option (2.2) when you have either not-performed transactions (transD) or already-performed transactions (transH). Occasionally, users do not want to create put-away tasks when they receive items. They create transactions and put away items using RF

on-the-fly transfers. They may still want to create labels for pallets when they receive, though. To do this, they create a routing from Receiving to Receiving to avoid creating transactions. Without transactions, the system previously would not let them print the labels from the RF Reprint option.

- 22** The system now correctly updates allocated quantities and location information in the pre-shipper when multi-box picking during batch picking,
- 23** AIM no longer creates put-away (PA) transactions with decimal quantities when several lots are needed for replenishment. AIM now rounds decimals and creates integer quantities in the replenishment.
- 24** AIM no longer displays a Progress error when receiving lot-controlled items in Purchase Order Receipts (5.13.1) when both Multi Entry and Receive All are set to Yes. Also, the system now displays the correct pop-up frame when Chg Attribute is set to Yes in Purchase Order Receipts and you are receiving lot-controlled items.
- 25** AIM no longer incorrectly displays negative quantities in the CONSO(LIDATE) column in Order Detail Status Inquiry (80.15.9).
- 26** AIM now checks whether a storage location group (SLG) can receive items or issue inventory before transferring items and creating transactions. Warehouse staff cannot issue items in an SLG if Allow Issues is set to No and cannot receive items if Allow Receipts is set to No in Storage Location Maintenance (80.3.1).
- 27** AIM now checks whether a multi-item pallet contains allocated items, and if yes, AIM no longer lets warehouse staff transfer the pallet.
- 28** In Work Order Operation Backflush (16.19) when backflushing for quantities that span more than one pallet, the system now correctly displays multi-entry screens.
- 29** AIM now checks whether stock is consigned in Transfer Single Item (80.17.4). If stock is consigned, you cannot change site, lot/serial, or reference details for consigned stock. This is consistent with the way other MFG/PRO functions manage consigned stock.
- 30** When reconciling drafts in Draft Bank Reconciliation (27.6.6.17), the system no longer resets the Multi Entry field to No if previously set to Yes when AIM is active.

# Release Notes for Version 3.0 and SSD 3.0

**Advanced Inventory Management Version:** 3.0 and SSD 3.0

**MFG/PRO Compatibility for 3.0:** eB, initial release through Service Pack 5

eB2, initial release through Service Pack 11

**MFG/PRO Compatibility for SSD 3.0:** eB2.1, Service Pack 2, 3, and 4

**Supported languages:** US English, Castilian Spanish, Dutch, French, German, Italian, Polish, and Brazilian Portuguese

## Documentation Updates

The documentation for AIM 3.0 features described here is included in an updated *User Guide: Advanced Inventory Management (AIM)*, item 78-0650A.

Installation and upgrade instructions can be found in *Installation Guide: Advanced Inventory Management (AIM)*, item 78-0649A.

## New Features Overview

This release includes the following new features:

- New Wave Planning Features
- New Containerization Features
- New Container Move Features
- New Truck Ship Features
- Enhanced Lane and Dock Management Capabilities
- Added New Generalized Codes Maintenance Utility for Domains
- Support for Multi-Item/Lot Pallets in PO Receipt Processing
- Expanded RF Capabilities
- New Barcode Prefix Features
- Enhanced Support for UCC/EAN-128 and SSC Codes
- Enhanced Batch Task Priority Capability
- Added New Generalized Codes Maintenance Utility for Domains

## New Wave Planning Features

New wave planning features let you create a *wave*, which is a collection of either sales orders (SO), scheduled orders, or distribution orders (DO). Warehouse staff can pick for the collection of orders together at a certain point in time. For example, if you know that a carrier arrives at 4:00 pm, you can create a wave for all orders linked to the carrier.

Organizing the picking activities by wave lets you:

- Spread the workload for picking activities across the entire business day.
- Start picking activities on time for carrier arrival at the dock.
- Streamline the picking operations by having a continuous throughput of stock across the warehouse; this gives you better use of warehouse resources and avoid peaks.

- Spread the workload in aisles and shipping lanes based on carriers so that items are moved to the correct shipping lane for a particular carrier type.
- Save time and tasks by fulfilling order lines with full pallets or boxes that you can move directly to the dock, bypassing picking and other areas.
- Use waves interactively to initiate some tasks and release orders before one wave is complete while starting tasks for another wave.
- Manage throughput of large quantities by releasing orders in a wave incrementally or all at once.

Wave planning lets you plan the picking and replenishment activities so that you have control over all workload areas of a warehouse. This lets you balance the workload, keep warehouse staff busy without over-tasking them, and manage the overall order processing and throughput of multiple items on multiple order lines from multiple orders.

### Basic Wave Steps

The basic processing flow of wave planning is as follows:

- 1 Wave selection
- 2 Wave replenishment
- 3 Wave release

Separate wave programs let you complete each of these major steps. In addition to these basic steps, new wave programs let you:

- Define lanes and docks.
- Assign lane and dock algorithms.
- Define lane and workload groups.
- Assign lane groups.
- Set general control options.

### New Wave Programs

The Detail Picking Menu is now the Wave Planning/Batch Picking Menu (80.15). The menu provides the following new wave planning programs:

Menu Number	Description	Program Name
80.15.1	Wave Selection	whwavemt.p
80.15.2	Wave Status Inquiry	whwastat.p
80.15.3	Open Order Report	whwaopr.p
80.15.4	Wave Replenishment	whwarpmt.p
80.15.5	Wave Release	whwaremt.p
80.15.6	Wave Release Groups Create/Activ	whwargmt.p
80.15.7	Wave Release Groups Activation	whwargac.p
80.15.8	Wave Release Groups Inquiry	whwargiq.p
80.15.9	Order Detail Status Inquiry	whomstiq.p
80.15.10	Wave Open Order Inquiry	whwaooiq.p
80.15.11	Wave Detail Report	whwaverp.p
80.15.12	Wave Close	whwaclmt.p
80.15.13	Lane/Dock Maintenance	whlanemt.p

Menu Number	Description	Program Name
80.15.14	Lane Browse	whbr201.p
80.15.15	Lane Group Maintenance	whlagpmt.p
80.15.16	Lane Group Inquiry	whlagpiq.p
80.15.17	Lane Group Report	whlagprp.p
80.15.18	Workload Group Maintenance	whlogpmt.p
80.15.19	Workload Group Inquiry	whlogpiq.p
80.15.20	Workload Group Report	whlogprp.p
80.15.21	Lane Group Assignment	whlaasmt.p
80.15.23	Wave Planning Control	whwaplpm.p
80.15.24	Batch Picking Control	whbbpkpm.p
80.16	Replenishment Menu...	
80.16.1	Replenishment List Maintenance	whrprgmt.p
80.16.2	Replenishment List Inquiry	whrprgriq.p

## New Wave/Batch Utility Programs

The following programs were added to the Wave Utility Menu (80.15.22).

Menu	Program	Description
80.15.22.1	Wave Unprocessed Orders Inquiry	Displays a list of all items that are not set up correctly for wave processing. Displays the order or item, create date and time, the login ID of an user locking an order, and wave setup errors for the item or order in a nonconformity reason (NCR) column.
80.15.22.5	Wave Task Inquiry	Display picking tasks for each wave.
80.15.22.7	Container/Shipper ID Inquiry	Displays all containers corresponding to either a pre-shipper or container ID. You can also find container IDs by order, order line, and ship-to or sold-to code.
80.15.22.13	Wave Priority Boost	Use this utility to change the priority of the order.
80.15.22.20	Wave Close Batch/Report	Displays closed waves but also lets you close a wave or batch of waves with shipped orders or no open orders.
80.15.22.21	DO Shipper Delete/Archive	System administrators or wave planning managers can delete or archive temporary DO shippers and delete or archive DO containers when staff complete a DO shipment.
80.15.22.22	Wave With Blank AbsID Report	Displays waves by wave number, the number of tasks, and the blank ABS IDs as 0 (zero). You can optionally display only failed waves.
80.15.22.23	Wave Planning Orders Initialize	If you have open orders in the system when you install AIM, use this utility to update MFG/PRO customer schedule order line due dates in AIM and mark all orders that are allocated and used by AIM's sort Algorithm 1.

## New Containerization Features

*Containerization* is the process of assembling pallets and orders for a shipment. In MFG/PRO, you can manually create a container and link it to a pre-shipper/shipper in Pre-Shipper/Shipper Workbench (7.9.2); however, this capability did not exist previously for the RF device.

The existing containerization available through the RF device is for containers that warehouse staff build while detail picking or batch picking. This type of containerization is part of the complete picking process and is limited to one level; that is, during picking, staff can only create a container for a box or pallet and put items into it during the picking process.

AIM now provides multi-level containerization through the RF that lets staff assemble pallets for shipment until all shipments for a particular customer ship-to address are complete. A new RF containerization option lets warehouse staff use the RF to place all boxes or pallets they filled during picking onto other containers for shipping.

The RF containerization functionality is available for both sales orders (SO) and distribution orders (DO). For SOs, warehouse staff can create a container and link it to a pre-shipper number. Through the RF device, warehouse staff can create a new or modify an existing pallet and attach boxes to the pallet. When they do, AIM updates the shipper to reflect this.

## Containerization Features

AIM containerization features let warehouse staff:

- Choose to scan boxes first, then select from a list of pallets to put them on; or, to open a pallet first, then scan boxes to add to it.
- Transfer a scanned box to a pallet that is in another location on the same shipper.
- Remove boxes from containers or pallets.
- View pallet contents.
- View order status or shipper data that reflects containerization in AIM.
- View the number of boxes already containerized and the remaining boxes to be containerized on the RF.
- Move a container and its contents to a truck, with the system moving all containerization levels and detail allocations with the container.
- Merge a pallet into another pallet.
- Create a container level for a full pallet.

## New Utility to Delete Shipper Containerization Data

AIM does not contain RF shippers; however, during shipping, the RF Container Bld option creates containerization tables. System administrators can use the new DO Shipper/Delete Archive (80.15.22.21) to delete/archive the containerization tables to avoid an impact on system performance.

## New Container Move Features

After your staff assemble pallets to ship to customers, they can use AIM's new container move functionality to move allocated boxes or pallets from the dock location to a truck location. Container move functionality lets you create a new RF location transfer transaction and define a truck as a location.

AIM provides new container move features that:

- Let warehouse staff move any pallet with detail allocation and containerization to any other location, including another truck.
- Optionally, let you add staging or validation steps when moving containers.
- Facilitate cross-docking functionality.
- Transfer items from one truck to another or use an entirely different carrier.
- Report the position of each pallet in the truck.

## New Truck Ship Features

AIM provides new truck ship functionality that creates a transaction that documents sales orders simultaneously as they ship on the truck and automatically creates a bill of lading (BOL) for the truck shipping.

AIM's new truck ship features:

- Let you indicate truck shipment, resulting in MFG/PRO shipment of all orders on the truck.
- Automatically print a bill of lading (BOL) for the truck shipment.
- View all shippers loaded on the truck for a given truck location.

## Enhanced Lane and Dock Management Capabilities

You can now define a lane or a dock as a location in AIM to use when processing waves. Use Location Maintenance (80.3.13.1) to define a shipping lane or a dock as an AIM location; then use the new Lane/Dock Maintenance (80.15.13) program to further define the shipping lane or dock.

You can also set up the shipping lanes and docks as dedicated areas where you process orders in a specific way; for example, for a specific carrier type.

AIM now includes new shipping lane (LA type) algorithms and new dock (CM type) algorithms that you assign to the shipping lane or dock using Algorithm Assignment Maintenance (80.6.9).

The new shipping lane algorithms find lanes for a given carrier, unassigned lanes, or lanes with the lowest number of tasks assigned to them.

The new dock algorithms find the first location defined as a stage location, empty stage locations, stage locations that already contain stock for the SO shipper or DO ship-to code, stage locations with the least number of containers/pallets, and so on. They also find truck locations, empty dock locations, dock locations with the least number of pallets, and so on.

For both shipping lane and dock algorithms, you can define a combination of algorithms. The system finds a shipping lane using the first algorithm in the list. If it does not find any, it considers the next algorithm to use, and so on.

## Enhanced Replenishment Capability

Using the RF, warehouse staff can now select a multi- or single-item pallet from the reserve area and replenish one or multiple locations from the pallet in the picking area. After staff replenish, they can return the remainder on the pallet to the reserve area.

Staff can select a complete pallet, then replenish in the home (dedicated) location. If you set up AIM to use the RF pallet overpick program, at this point, AIM is using overpick logic. AIM displays the quantity to replenish in the location on the RF, but staff typically put as much as they can into the home location. The remainder of the pallet that is not used for replenishment is returned to stock using AIM put-away logic. For this reason, this functionality is termed *overpick replenishment and put away*. Staff can return items individually from a multi-item pallet or return the complete pallet.

Using the single pallet, the user can optionally:

- Meet the total replenishment requirement for a pick.
- Replenish more than the total replenishment requirement for a pick.
- Replenish less than the total requirement for a pick.

## New Local Exit Routine

AIM provides a new program to use with overpick replenishment and put-away functionality. You specify this program in a new RF Pallet Overpick (whrfmbr1.p) field in Local Exit Routine Control (80.24.23). The whrfmbr1.p program is included with AIM and defaults to the RF Pallet Overpick (whrfmbr1.p) field. If you do not specify a program in this field, AIM uses the standard whrfmbr1.p replenishment program for the RF Next Task/Select Task option.

## Support for Multi-Item/Lot Pallets in PO Receipt Processing

Staff can now receive a multi-item or multi-lot pallet and use a single task to move the pallet to the destination location. The put-away process can now find a single location for the entire pallet and no longer sends different pallet components to different locations.

Warehouse staff can use the new RF PO Receipt menu option to receive multi-item pallets. When a shipper does not exist, the system lets staff manually create pallets and enter different pallet components.

AIM now creates a task for multi-lot/item pallets that is different than those created for single-item pallets. For multi-lot/item pallets, the task item number is the pallet item number.

Since AIM does not display the total amount of units for all items on the pallet, the system now displays the quantity in AIM reports and inquiries as one pallet. You can use Warehouse Transaction Inquiry (80.9.1) to view the single task to move the pallet. Also, when you select a multi-item pallet for a transfer using Transfer by Reference (80.17.1), the item that displays is the pallet item and the quantity is a single pallet. When you select the reference, a warning indicates that the pallet is a multi-item pallet.

## Expanded RF Capabilities

The Radio Frequency (RF) menus now include options for features introduced in this release:

RF Menu Number	Option	Description
1.8	PO Receipt	Lets staff receive POs with multi-lot/item pallets.
3.3	Container Bld	Lets staff create containers and container levels, transfer a scanned box to a pallet, remove boxes from containers/pallets, view pallets to use, view boxes already containerized, and so on.
3.4	Move Container	Lets staff move any pallet with detail allocation and containerization to any other location, add staging or validation steps when moving containers, facilitate cross-docking functionality, report pallet truck positions.
3.5	Ship Truck	Lets staff indicate truck shipment, resulting in MFG/PRO shipment of all orders on the truck; automatically print a bill of lading (BOL) for the truck shipment; and view all shippers loaded on the truck for a given truck location.
3.6	Pallet Explosion	Lets staff pick a single-lot/item pallet from the reserve storage area, display pallet contents, and add MFG/PRO containers to an exploded pallet.

## Expanded RF Function Key Use

The following new RF function keys let you perform more tasks during batch picking and wave processing.

Function Key	Description	Task
F2	Display order comments for sales and distribution orders on the RF screen. Press F2 on any field in the picking screen to view the order line comments.	Picking
F3	Display the order picking status. AIM displays pick information per order, including the item number, the quantity already picked, and the quantity remaining to pick.	Picking
F3	Fails the task. The system creates a recount task.	Overpick replenishment and put-away
F5	Skip a task and move it to the end of the task queue. This is useful, for example, should a warehouse aisle become blocked.	Any task
F6	If all tasks are for the same destination, the system displays the Drop All prompt, letting you drop all or some boxes completed during picking.	Picking
F6	Lets staff repick missing items.	Overpick replenishment and put-away
F7	Move contents from one box to another box during picking. This helps staff balance the content of different boxes based on the volume of the different items. The system prompts for a new container ID.	Picking

**Note** Some UNIX terminals, Linux terminals, and RF devices do not map the F5 key. Typically, terminal users can use the emulation software's key.

## New RF On-the-Fly Transfer Feature

RF users can perform an on-the-fly (OTF) transfer if they need to reorganize the warehouse when it is full or clear aisles of pallets. You can use a new OTF-TR transaction type, then set up and link algorithms and internal routings so that RF users can select RF Transfer (1.3) and perform OTF transfers within a single warehouse.

## New Barcode Prefix Features

A new program, Barcode Prefix Control (80.19.24), lets you define RF barcode prefixes. Warehouse staff print barcode prefixes on barcode labels for a customer or ship-to, then scan barcode shipping labels when building shipments. The system uses the barcode prefixes to validate that the correct barcode data was scanned. You can now define up to a four-digit prefix for any or all of following fields:

- Date
- Location
- Reference
- Quantity
- Item
- Lot/serial
- Tote

Using prefixes when scanning barcode labels lets your company meet some industry-specific standards such as those set by the Automotive Industry Action Group (AIAG).

## Alternate Barcodes

You can also enter two alternate barcodes to use in lieu of barcodes with prefixes in new Barcode 1 and Barcode 2 fields in Item Master Maintenance (80.4.5).

## Enhanced Support for UCC/EAN-128 and SSC Codes

AIM now lets you specify programs that read and interpret:

- Universal commercial code (UCC)/European Article Number (EAN)-128 codes
- Serial Shipping Container Codes (SSCC)

You can specify that AIM use the non-encrypted `whean128.p` program for UCC/EAN-128 codes or the non-encrypted `whsscc.p` program for SSCC in Barcode Prefix Control (80.19.24). AIM runs both programs during batch picking.

The `whean128.p` program reads and interprets UCC/EAN-128 codes and supports a subset of UCC/EAN application identifier (AI) prefixes.

During batch picking, when staff scan an SSCC, the `whsscc.p` program extracts the enterprise code, verifies that it corresponds to the site, verifies that the SSCC check digit is correct, and displays the eight-digit pallet reference for the scanned container or tote.

You can also use the new Barcode Functions Testing (80.19.13) to test barcode results when you use the `whsscc.p` or `whean128` programs. For example, when you use `whsscc.p`, you can run a test to ensure that AIM uses the eight characters before the last check-digit character at the end of the SSCC barcode.

## Enhanced Batch Task Priority Capability

A new Task/Priority Update Report/Batch (80.11.11) lets you change the priority of batch picking tasks. You can enter a range of sites or warehouses, then enter a period in minutes that determines how old tasks must be before the system increases the priority of the task. After taking the delay period you specify into account, the frequency at which the system changes task priority is defined by the frequency at which you run a batch picking program. When you run AIM batch picking, AIM increments the task priority when it creates the tasks.

## Added New Generalized Codes Maintenance Utility for Domains

For AIM SSD, the new Generalized Codes/Domain Utility (80.24.21.4) lets you synchronize a domain's default system data field values with AIM system data field values that you specify in Generalized Codes Maintenance (80.24.21.1).

During installation, many generalized code values are predefined and loaded into the system. When you create a new domain, this default system data is included. Set AIM System Data to Yes in Generalized Codes Maintenance to specify that system data field values you define are for AIM system data fields. When AIM System Data is Yes, and you specify the domain in Generalized Codes/Domain Utility, the system synchronizes the values.

## Removed Detail Picking Functionality

All Detail Picking functionality is removed from AIM 3.0 and considered obsolete. Enhanced batch and wave picking replaces detail picking.

## Fixes

- 1 When RF users perform cycle count and recount tasks, AIM now displays warning messages when RF users attempt to cancel:
  - Tasks when a count/recount is in progress.

When staff cycle count a task to 0, they cancel the task, and confirm the count to 0. This removes the task, the detail allocation, and the shipper line, and puts the detail pick quantity back to a general allocation. A message now displays if staff attempt to cancel tasks when a count/recount is in progress that warns that cancellation can occur only when the stock has been changed to 0 when staff confirm the count or recount to 0.
  - Cycle count/recount of a new item in a bin location if there is only a single pallet in that location using Location Audit (1.6).
- 2 The system no longer creates multiple cycle count tasks for the same inventory during a certain period of time.

If multiple picks exist for the same inventory and the stock quantity is wrong, different pickers may fail the task and create multiple cycle count tasks. To avoid multiple recounts, AIM now considers the opportunity count (OPC) frequency field in Location Maintenance (80.3.13.1). By considering the OPC field, the system knows when the location was last recounted and does not create multiple recounts.
- 3 Stock movements are now correct when staff specify No to the Drop All? RF prompt during batch picking.
- 4 When you specify Reference in the Container/Reference field in Batch Picking Control (80.15.24), batch picking for distribution orders now works correctly.
- 5 Pre-Shipper/Shipper Inquiry (7.9.3) correctly displays the last box reference and content quantities after RF staff batch pick to multi-boxes using references and confirm a drop off.
- 6 AIM now correctly deletes DO picking tasks when you delete the DO in Distribution Order Maintenance (12.17.14).
- 7 The RF PO Receipt (1.8) option now works correctly with the optional PRO/PLUS Supplier Performance module (5.15).

When Supplier Performance is enabled, the RF PO Receipt option now correctly displays the supplier performance Date field, and the RF screen now displays all supplier performance messages related to the date field.
- 8 The cross-docking shortage clearance now works correctly when you set the Shortage Action field to option 1 in Transaction Type Maintenance (80.7.6).

When you set cross-docking shortage action to option 1 for a shortage clearance, the system creates a warehouse transaction and creates general allocations; the general allocations now work correctly.
- 9 The Item Number field in Inventory Detail Inquiry (80.9.13) was expanded to fit 18 characters.
- 10 The system now records order data correctly in abs\_mstr when RF staff move items using the RF Move Item (3.7) option.

## Release Notes for Version 2.3c.1 and SSD 2.3c.1

**Advanced Inventory Management Version:** 2.3c.1 and SSD 2.3c.1

**MFG/PRO Compatibility for 2.3c.1:** eB, initial release through Service Pack 5

eB2, initial release through Service Pack 5,  
Service Pack 7 through Service Pack 10

**MFG/PRO Compatibility for SSD 2.3c.1:** eB2.1, Service Pack 2 and Service Pack 3

**Supported languages:** US English, Castilian Spanish, Dutch, French, German, Italian, Polish, and Portuguese

**Installation Guide:** *Advanced Inventory Management* item 78-0628D

**User Guide:** *Advanced Inventory Management* item 78-0591C

# Release Notes for Version 2.3c and SSD 2.3c

**Advanced Inventory Management Version:** 2.3c and SSD 2.3c

**MFG/PRO Compatibility for 2.3c:** eB, initial release through Service Pack 5

eB2, initial release through Service Pack 5,  
Service Pack 7 through Service Pack 9

**MFG/PRO Compatibility for SSD 2.3c:** eB2.1, Service Pack 2 and Service Pack 3

**Supported languages:** US English, Castilian Spanish, Dutch, French, German, Italian, Polish, and Portuguese

**Installation Guide:** *Advanced Inventory Management* item 78-0628C

**User Guide:** *Advanced Inventory Management* item 78-0591B

## Installation

*Installation Guide: Advanced Inventory Management*, item 78-0628C, describes how to perform a new installation of AIM2.3c or AIM 2.3c SSD or upgrade an existing 2.0, 2.1b, 2.2a, 2.3a, or 2.3b implementation. A database conversion is required by changes introduced in 2.3a.

If you are implementing AIM 2.3c SSD, review the information in “AIM 2.3c SSD Implementation” on page 46.

## New Features Overview

- 1 A new Wave/Batch Picking Utility Menu (80.15.22) provides two new programs:
  - Batch Picking Crash Recovery (80.15.22.15) described on page 40.
  - Batch Picking Tasks Report (80.15.22.10) described on page 42.
- 2 You can now pick repetitive items from negative inventory in dedicated locations during a backflush. See “Backflushing Items From Dedicated Locations” on page 42.
- 3 You can now reassign tasks that are hard assigned to a user. See “Reassigning Hard Assigned Tasks” on page 43.
- 4 You can now specify that warehouse staff pick to a kit when batch picking. See “Batch Picking to a Kit” on page 44.
- 5 You can now move items from one box to another to optimize storage based on volume. See “Moving Items to Another Box” on page 44.
- 6 You can now skip tasks. See “Skipping Tasks” on page 44.
- 7 Sales order header comments now display in the radio frequency (RF) device even when RF users select a pre-shipper. If the pre-shipper has multiple orders, the RF displays comments for the first order on the pre-shipper.

**Note** Sales order header comments display only if Print Packing List Comments is set to Yes in Sales Order Maintenance (7.1.1).
- 8 Warehouse staff can pick for a sales order without creating an MFG/PRO pre-shipper in Sales Order Packing List (7.9.13).

- 9 You can now merge the following order types in the same box when batch picking:
- Distribution orders, work orders, and sales orders
  - Sales orders on different pre-shippers
  - Distribution orders with different destination sites

10 The Detail Picking Menu (80.15) is now the Detail/Batch Picking Menu.

## Batch Picking Crash Recovery

Previously, when the system crashed, all tasks selected by the user in batch picking were either active or open; however, because the tasks were hard assigned to the user, only the person assigned the tasks could view them. Since the tasks were not viewable, you could not assign them to anyone else. Moreover, the system modified tasks performed so that stock already picked was in the user location (cart). The only way to correct this situation was to use a tedious manual process involving Standard Transaction Maintenance (25.13.1), Pre-Shipper/Shipper Workbench (7.9.2), and AIM movement confirmation programs in the AIM Process Menu (80.8).

Two new batch-picking crash recovery features let you recover, confirm, and view picking tasks that took place when the system crashed or connections were lost:

- Crash Recovery Utility (80.15.22.15).
- Crash recovery features built into batch-picking functionality; see “Built-In Recovery” on page 42.

## Crash Recovery Utility

You can use a new Crash Recovery Utility to confirm tasks completed by warehouse staff and information processed by the system when a system failure occurs. The utility:

- Lets you view unprocessed tasks for a specific user, site, and warehouse combination or for all users for a warehouse/site combination.
- Lets you confirm tasks completed before the system failure.
- Lets you drop off all or some completed boxes at shipping lanes or a staging area.
- Makes selected, but not picked, tasks available to the user again; see “Task Availability” on page 42.

To use the utility to confirm tasks and drop off boxes, use the following procedure:

1 Enter the user ID of the warehouse staff whose tasks you want to confirm. Optionally, leave blank to show all unconfirmed tasks for the site and warehouse you specify.

2 Enter a site and warehouse.

The utility displays picked, but unconfirmed tasks that were interrupted because the system went offline. The system displays the task number, user ID, destination location, packing container, and the quantity picked/to pick in a read-only frame. See Figure 1 on page 41.

3 When tasks display, press F1.

If all tasks are for the same destination, the system displays the `Drop All` prompt.

If tasks are for different locations, the system prompts you to enter a location. Go to Step 5.

**Note** The drop-all functionality is the same as that for the RF device. See “Dropping All or Some Boxes” on page 50.

4 At the `Drop All` prompt, specify whether staff drop some boxes to another location or drop all boxes to the same location:

No: Staff drop some boxes one by one to another location. Go to Step 5.

Yes: Staff drop all boxes to the same location. Go to Step 6.

- 5 Enter the new location in the To Loc field.

**Note** The container and order that display are read-only fields. The system prompts once for the container and order that display, even when there are multiple tasks for the same box. See Figure 2 on page 41.

- 6 Confirm the task completion by specifying Yes at the OK to Confirm prompt.

The system displays the number of confirmed tasks.

Fig. 1 Crash Recovery Utility (80.15.22.15)

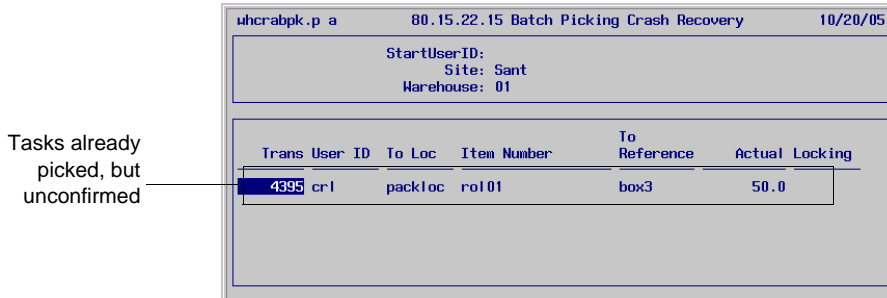

**Start User ID.** Enter the ID for the user whose picking tasks you want to confirm or leave blank to display all unprocessed tasks for users of a site/warehouse combination.

**Site.** Enter the site for the tasks you want to see.

**Warehouse.** Enter the warehouse for the tasks you want to see.

**Drop All.** Specify whether staff drop some boxes to another location or drop all boxes to the same location.

No: Staff drop some boxes one by one to another location.

Yes: Staff drop all boxes to the same location.

**Container.** The container ID for the box you want warehouse staff to drop off. You cannot edit this field.

**Order.** The order number for the box. You cannot edit this field.

**To Loc.** Enter the location where warehouse staff drop off boxes.

**OK to Confirm.** Specify whether to confirm the batch-picking tasks that display.

No: Do not confirm the tasks. The system displays 0 (zero) tasks confirmed.

Yes: Confirm the tasks. The system displays the number of tasks confirmed and a list of confirmed tasks.

Fig. 2 Crash Recovery Utility (80.15.22.15), Location Change Prompt

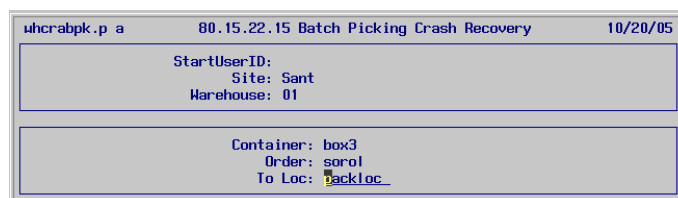

## Task Availability

There may be other picking tasks that warehouse staff selected but failed to process because of a system failure. The recovery utility ensures these tasks have an open status and are unassigned and available to be processed by any user from the RF batch-picking program. Use Warehouse Transaction Inquiry (80.9.1) to view the status of the tasks.

## Built-In Recovery

Warehouse staff who were batch picking from an RF device can automatically resume picking when they are back online. The system skips the order-selection frame on the RF and redisplay the picking screen that displayed when the system went offline. The recovery functionality ensures that tasks previously selected but not picked are available for picking. Warehouse staff can resume picking and dropping off all or some boxes as usual.

## Batch Picking Tasks Report

A new Batch Picking Tasks Report (80.15.22.10) displays all open batch-picking tasks. Use the report to determine which tasks warehouse staff have performed and when. You specify the site and warehouse, then enter a range of item numbers or transaction numbers. See Figure 3.

Fig. 3 Batch Picking Tasks Report (80.15.22.10)

*Site.* Enter the site for the open tasks you want to report.

*Warehouse.* Enter the warehouse for the open tasks you want to report.

*Item Number/To.* Enter a range of item numbers with open tasks.

*Transaction/To.* Enter a range of transaction numbers with open tasks.

The system reports information from transaction history and displays the open tasks for the item or transaction. Figure 4 shows a report with open tasks by transaction.

Fig. 4 Open Tasks Reported

Trans	Original From Loc	From Location	To Loc	From Item Number	Actual	Expected	Closed	Time Closed
3920	blklloc01	nqa	packloc	date	3.0	10.0	09/30/05	07:11:35
3919	blklloc01	nqa	packloc	cul	3.0	10.0	09/30/05	06:51:24
3918	blklloc01	nqa	packloc	fil	10.0	10.0		00:00:00

End of Report

## Backflushing Items From Dedicated Locations

You can now backflush repetitive items from a dedicated location. Dedicated locations, or home locations, are picking area locations that always store the same item. AIM now includes a new PK algorithm (algorithm 70) that finds stock in a dedicated location, so warehouse staff can now pick items in the dedicated location. The PK algorithm works with a new PICK-RBK transaction type that backflushes

repetitive items from a dedicated location. You can modify parameter settings for the new PICK-RBK transaction type in Transaction Type Maintenance (80.7.6).

To use the new PICK-RBK transaction type, you must set up the algorithm for use by performing the following:

- 1 Use Algorithm Master Maintenance (80.6.5) to optionally modify the description of the new pick-by-dedicated location algorithm.
- 2 Use Transaction Type Maintenance (80.7.6) to review the transaction and Whse Master List Maintenance (80.1.5) to ensure that the PICK-RBK transaction is linked to the item you want staff to pick from the dedicated location.
- 3 Use Algorithm Assignment Maintenance (80.6.9) to link the algorithm sequence to the PICK-RBK transaction. This ensures that AIM uses the correct algorithm when it processes inventory from the dedicated location.
- 4 In Location Maintenance (80.3.13.1), specify the physical location for the dedicated location in the header and set the Dedicated field of the AIM Location Data frame to Yes. This ensures the location is for only one item or product. See Figure 5.

Fig. 5 Location Maintenance (80.3.13.1), AIM Location Data Frame

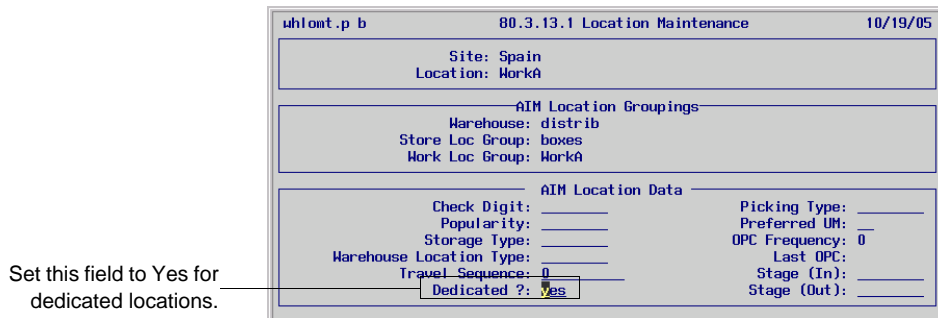

### Picking from Negative Inventory during a Backflush

Warehouse staff do not always have the time to update the system with the last transfer. During a backflush, this can result in a negative inventory from a system point of view. Warehouse staff can now pick components during a repetitive backflush from a dedicated location even when the inventory is negative. AIM lets warehouse staff pick from negative inventory for transaction type PICK-RPS when the inventory status code associated with the location has Overissue set to Yes in Inventory Status Code Maintenance (1.1.1). Warehouse staff can now continue to receive work orders and continue with shipping when inventory is negative. You can check the status of the inventory using Inventory Detail Inquiry (80.9.13).

### Reassigning Hard Assigned Tasks

In AIM, tasks are hard assigned to the user; that is, by default all tasks for the selected order/pre-shipper/customer combination are assigned to the user only and viewable by the user only. You can now restrict the number of tasks assigned to a user and resort tasks by editing the whbpk1x2.p sorting procedure. The sorting procedure is the default procedure in the Batch Picking Task Sort field in the Local Exit Routine Control File (80.24.23).

You can edit whbpk1x2.p to change the following default task-sorting order:

- Travel sequence
- Alphabetical order of location

- Task priority (descending, highest priority first)

Additionally, since the `whbpbk1x2.p` program receives the current user ID parameter, you can use the sorting procedure to retrieve all tasks assigned to a user. Once retrieved, you can resort the tasks and remove task assignments based on any logic. For example, you can resort tasks by weight rather than travel location so that pickers can place heavy items on the bottom of a pallet. You can add a look-up window to the `whbpbk1x2.p` program so that warehouse staff can resort the tasks manually before starting to pick.

## Batch Picking to a Kit

You can now pick to a kit in addition to picking to a box when batch picking. A kit is a set of items that are picked for shipment. No real assembly takes place. The configured item is not itself a physical entity—it only exists as a logical superset of its components. The configuration defines the content of a kit, and a shipment contains the end items that comprise the kit. You set up kits as configured items in MFG/PRO. See Chapter 9 of *User Guide: Volume 2A Distribution*.

To pick to a kit, specify a kit as a reference by setting the Container/Reference field in the Batch Picking Control File (80.15.24) to Reference. When you specify a kit as a reference, the system uses the reference field of the inventory record as the placeholder for a kit number. All items placed in the same kit have the same reference number.

Fig. 6 Batch Picking Control File (80.15.24)

uhbpbkpn.p 80.15.24 Batch Picking Control File 02/15/05

Site: \_\_\_\_\_  
Warehouse: \_\_\_\_\_

Include Sales Order ?:	Scan Location ?:	Required
Include Distribution Order ?:	Scan Item ?:	[ ]
Include Work Order ?:	Scan Lot/Serial ?:	[ ]
SD Batch Selection:	Scan Reference ?:	[ ]
Allow Merge Orders ?:	Scan Quantity ?:	[ ]
Close Option:	Single Packing Location ?:	
AutoSel:	Default Packing Location:	
Maximum Selection:	Label Print Option:	
Maximum Picked Cases:	Post Print Option:	
Container / Reference:	Label Print Program:	
Container Sequence ID:	RF Screen Height:	
Container Item:	Logical Format:	
Container UM:		
Modified:		

Set this field to Reference for a kit.

## Moving Items to Another Box

Warehouse staff can now press F7 on the RF device to move contents from one box to another box during picking. This helps staff balance the content of different boxes based on the volume of the different items. Once staff press F7, the system prompts to enter a new container ID. See Figure 7.

Fig. 7 RF Move Box Prompt

```
*** ITEM MOVE ***
Container: _____
```

## Skipping Tasks

Users can now press F5 on the RF device to skip a task and move it to the end of the task queue. This is useful, for example, should a warehouse aisle become blocked.

**Note** Some UNIX terminals, LINUX terminals, and RF devices do not map the F5 key. Typically, terminal users can use the emulation software's key mapping tool; however, users may require the Progress `protermcap` file to map the F5 key. For RF devices, key mapping may depend on hardware vendors.

## Fixes

- 1 In the RF batch-picking program, the Destination Reference field is now updated with the box number when batch picking for distribution orders.
- 2 If you press F3 in the Order Selection frame of the RF, the batch picking program no longer crashes.
- 3 Batch picking now works when you activate the PRO/PLUS Supplier Performance (5.15) module.
- 4 Warehouse staff can receive a pallet in one location with two identical internal routings (IR) without creating a new task.
- 5 AIM now automatically creates multiple references for pallets when staff receive serialized items on multiple pallets using one of the following receipt programs:
  - Receipts–Unplanned (3.9)
  - Purchase Order Receipts (5.13.1)
  - Work Order Receipt (16.11)
  - Work Order Receipt Backflush (16.12)
  - Work Order Operation Backflush (16.19)

- 6 AIM now works correctly with reserved locations introduced in MFG/PRO eB2. A reserved location is an eB2 feature that lets you reserve stock that is in a location for a particular customer. AIM now:
  - Provides a PK algorithm (algorithm 103) to pick in the reserved locations
  - Provides algorithms that reject reserved locations if staff do not pick for a ship-to code with a reserved location

You can modify parameter settings for the algorithms in Algorithm Master Maintenance (80.6.5).

- 7 With distributed orders, when you transfer items with an expiration date, the receiving site now includes the expiration date for the item.

When an item with an expiration date was transferred with distributed requirements planning (DRP) to another site, the receiving site excluded the expiration date and left the date blank or recalculated it. Expiration dates are important, especially for warehouses that store food, so receiving sites in AIM now have the same expiration date as the sending site.

- 8 AIM triggers in DRP now work correctly.

When a receipt location changes from an AIM location to a non-AIM location, the trigger to generate references is no longer set. Since warehouse staff stock goods during a receipt in either AIM or non-AIM warehouses, the trigger is not set until after the user enters the location.

- 9 Repick and cross-docking tasks are now added to any open pre-shipper.

Shortage clearance algorithms are used when receiving stock that is immediately required to fill short orders. The inventory is moved from receipt to dispatch, being stored in between. This type of movement is also known as cross-docking. A repick is new, typically shortened picking that staff perform, for instance, when inventory is missing and they want to fulfill the order quantity by picking the item in another location.

Previously, when you specified that the system perform a detail allocation during shortage clearance by setting Shortage Action to option 2, Inventory Transfer & Detail Allocation, in Transaction Type Maintenance (80.7.6), the system created a new pre-shipper instead of looking for an open pre-shipper. So, when staff repicked or picked for cross-docking, two or more shipper documents existed. Now the system looks for any open pre-shipper and adds lines to it. This only works if the pre-shipper was not converted to a shipper; if converted, the system adds the lines on a new pre-shipper.

10 Warehouse staff can now use shortage clearance algorithms with distribution orders.

## AIM 2.3c SSD Implementation

This section describes assumptions, limitations, and guidelines when implementing AIM 2.3c SSD.

### Assumptions

The following are assumed when implementing AIM 2.3c SSD:

- Settings in AIM control programs apply to all domains in a database.
- AIM can be used with multiple domains, but no cross-domain features are supported. You can use AIM functions only within a primary site within the current domain.
- Site-independent settings defined in AIM in the functions listed in Table 1 apply to all domains within a database.

**Table 1** Programs with General Settings

Function	Menu	Description
whermnt.p	80.2.13	External Routing Maintenance
whummt.p	80.5.1	Alternate UM Maintenance
whppugmt.p	80.5.5	UM-Group Maintenance
whppugen.p	80.5.9	UM Conversion Generation
whaltymt.p	80.6.1	Algorithm Type Maintenance
whalmt.p	80.6.5	Algorithm Master Maintenance
whtrtmt.p	80.7.6	Transaction Type Maintenance
whlmtkmt.p	80.11.1	Task Maintenance
whlmatmt.p	80.11.3	Alternate Task Maintenance
whlmtmt.p	80.11.5	Task Times Maintenance
whlmtamt.p	80.11.7	Task Assignment Maintenance
whlmusmt.p	80.11.13	User Maintenance
whsyugmt.p	80.11.15	Group Maintenance
whlmcamt.p	80.11.17	Calendar Maintenance
whsyugmt.p	80.19.1	User Group Maintenance
whcodemt.p	80.24.21.1	Generalized Codes Maintenance

### Limitations

AIM 2.3c SSD does not work with Enhanced Controls. Enhanced Controls tracks changes that were made for every record by using a unique key value. Enhanced Controls adds the unique key to all MFG/PRO tables. For AIM 2.3c SSD, the key is not added to AIM tables and the Enhanced Controls functionality does not apply.

### Guidelines

When implementing AIM 2.3c SSD, you should ensure that:

- Order numbers are unique across domains in the database; the same order number does not exist in two domains. You can do this by using a unique order prefix for each domain in the various programs that manage order numbering such as Sales Order Control (7.1.24).

- Item, customer, and supplier codes are either unique across domains or if the same numbers exist in more than one domain, they point to identical information. So, you can have a physical item, customer, or supplier with the same code in more than one domain or a with a different code in more than one domain; however, you cannot have the same code in more than one domain for the item, customer, or supplier if the code represents a different physical item or a different customer or supplier.

# Release Notes for Version 2.3b

**Advanced Inventory Management Version:** 2.3b

**MFG/PRO compatibility for 2.3b:** eB, initial release through Service Pack 5

eB2, initial release through Service Pack 5, Service Pack 7,  
Service Pack 8, and Service Pack 9

**Supported languages:** US English, Castilian Spanish, Dutch, French, German, Italian, Polish, and Portuguese

**Date:** May 20, 2005

**Installation Guide:** *Advanced Inventory Management* item 78-0628B

**User Guide:** *Advanced Inventory Management* item 78-0591B

## New Features Overview

This release adds features to batch picking introduced in the 2.3a release. See “Batch Picking” on page 54 for a description of this enhancement. The following list describes the most significant changes and fixes introduced with this version of AIM.

- 1 The Close Option in Batch Picking Control (80.15.24) no longer presents the choices to release an order and close the pick. It now presents choices to close containers. See “Closing a Container or Box” on page 48.
- 2 A new Release Orders Option was added to Batch Picking Control (80.15.24). The new Release Orders Option offers the choices previously presented by the Close Option field. See “Releasing an Order after Closing a Box” on page 49.
- 3 Staff can now drop off boxes at consolidation areas or shipping lanes before they complete batch picking for an order when all completed pick tasks have the same destination location. This lets them avoid scanning each box and the destination location for confirmation. See “Dropping All or Some Boxes” on page 50.
- 4 AIM now lets you define a user location as a cart location to temporarily store the stock until staff move stock to the shipping location. See “Specifying a User Location as a Cart” on page 52.
- 5 Two new local exit routines were added to Local Exit Routine Control (80.24.23). See “New Local Exit Routines” on page 53.

## Closing a Container or Box

The Close Option in Batch Picking Control (80.15.24) now lets you indicate actions for closing a container or box, not releasing the order. Figure 8 shows the Close Option in Batch Picking Control.

**Fig. 8** Batch Picking Control, Close Option

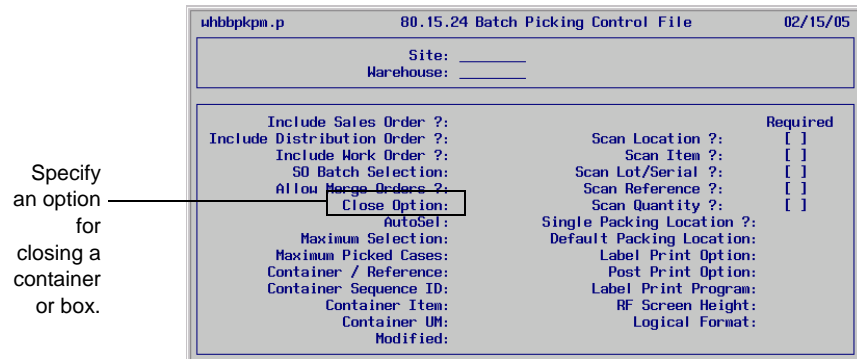

**Close Option.** Indicate the action to be performed when staff scan a container other than the one the system defaults in the batch-picking process.

When staff select a container for a given order, the system defaults that container for additional order lines to pick for the same order. If the container is full, staff can scan another container—new box or tote—and the system prompts to close the previous box.

If staff specify Yes to close the box, the system determines the action required for the remaining order lines through options you set in Release Orders Option. See “Releasing an Order after Closing a Box” on page 49.

0: Never close container. The system confirms the pick and leaves the previous container open. For the next pick on the same order, staff can use either an old or new container.

1: Always close container. The default container is closed. Because carts can hold only a certain number of boxes or totes, specify this option if it is not practical to open more boxes on the cart. The system determines whether it should continue proposing additional lines by options you set in Release Orders Option.

2: Prompt to close container. The system prompts to close the container and order. The system considers the option you set in Release Orders Option depending upon the response to this prompt.

## Releasing an Order after Closing a Box

A new Release Orders Option was added to Batch Picking Control (80.15.24). Figure 9 shows the Release Orders Option in Batch Picking Control.

**Fig. 9** Batch Picking Control, Release Orders Option

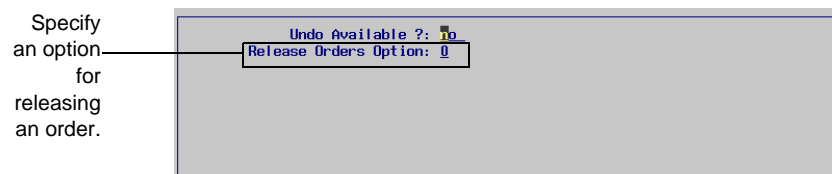

**Release Orders Option.** Indicate whether to release the order after staff close a box. Use this field in conjunction with the Close Option field. See “Closing a Container or Box” on page 48.

0: Never Release Order: When staff close a box, they can continue picking for the next order lines and open additional boxes for the order.

1: Always Release Order: Staff cannot open additional boxes and the picking process for the order is complete. You should unallocate all remaining picking tasks for the same order so that the system does not present remaining tasks to the picker assigned. You can assign remaining tasks to other pickers.

2: Prompt for Releasing Order. The system prompts to release the order and execute the appropriate action.

## Dropping All or Some Boxes

The orders for which staff pick can be very large. Occasionally, staff need to drop off boxes at consolidation areas or shipping lanes before they complete batch picking for an order. This is especially useful if staff are picking at locations that are close to the shipping lanes or consolidation areas.

When all completed pick tasks have the same destination location, warehouse staff can optionally drop off all items they finished picking. This lets them avoid scanning each box and the destination location for confirmation.

If one completed pick task is for a different destination location, staff can still drop off completed boxes, but they must drop off the boxes one by one, scanning the box number, then the location in which they drop off boxes, such as the shipping lane.

If all picked boxes are going to the same destination, for example, the same shipping lane, warehouse staff can press F6 on the RF during picking tasks to display the following prompt:

```
Drop All?
```

Staff should specify Yes to drop off all boxes for which they completed picking tasks if the destination location is the same for all boxes.

If one or more boxes are going to a different destination, then staff must scan each box and destination location each time they drop off a single box.

When the drop-off or drop-all is complete, the user can continue the batch-picking process for the remaining allocated tasks.

## Picking for Multi-Boxes

Batch picking sets the total quantity to pick based on the item, order, or location. However, the actual quantity to pick does not always equate to:

- The total quantity
- The number of items in full boxes

For example, warehouse staff can enter 67 each of an item as the total quantity to pick, but boxes are set to hold 20 each of the item. This means staff can pick three full boxes but cannot complete the pick without the remaining seven items.

Batch picking functionality lets staff pick complete boxes and create additional boxes that have less than the full amount. The system prompts warehouse staff to use another scan method. This lets staff print and paste a preprinted label on both the full boxes and the newly created box with the remainder of the items.

Batch picking functionality works with settings in Warehouse Maintenance (80.1.1) so that staff can complete picking when the quantity at a location is lower than the task quantity.

## Setting Location Maintenance Options

Occasionally, the quantity available in a location is lower than the task quantity; for instance, because of an inventory error.

You can set options in Warehouse Maintenance (80.1.1) so that the RF displays any or all of the following options when the quantity to pick is less than the total quantity:

- Repick option
- Complete option

- Fail option

If the user is picking for multi-boxes, when the user enters a quantity that is less than the total quantity but greater than 0 (zero), the system displays the following prompt:

Other scan?

If the user specifies No because the quantity at the location is less than the quantity needed for the actual pick, any or all of the options display, depending on settings in Warehouse Maintenance. If the user specifies 0 (zero) or if not picking for multi-boxes, the RF does not prompt for another scan and displays options to complete, fail, or repick the picking tasks. Figure 10 illustrates the fields to set in Warehouse Maintenance to display the options. The paragraphs following the figure describe the options.

**Fig. 10** Warehouse Maintenance, Complete/Fail/Repick Options

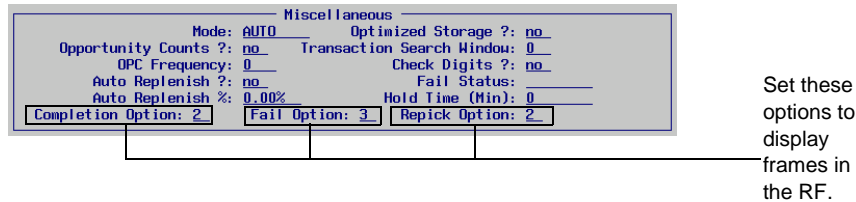

**Complete Option.** Enter one of the following completion options:

0 (the default): Always complete.

1: Default to complete.

2: Default to not complete.

3: Never complete.

**Fail Option.** Enter a fail option for failing a task:

0 (the default): Always fail.

1: Default to fail.

2: Default to not fail.

3: Never fail.

**Note** If you set Count on Fail to Yes in the Cycle Count Defaults frame of Warehouse Maintenance, the system creates a recount task for warehouse staff assigned this task.

**Repick Option.** Enter one of the following repick options:

0 (the default): Always repick.

1: Default to repick.

2: Default to not repick.

3: Never repick.

## RF Multi-Box Procedure

Use the following RF procedure to use multi-box picking to complete your picking tasks:

- 1 Select batch picking tasks as usual and enter the actual quantity you need to pick in the Qty field.

The system displays the following prompt:

Other Scan?

- 2 Specify Yes.

**Note** To use logical format on the RF, set Logical Format in Batch Picking Control.

- 3** Scan full boxes and the box with the remaining items that make up the total you need to pick.  
At each scan, the system displays the remaining quantity to pick and prompts you again to scan others until the quantity required is picked.
- 4** Print labels for full boxes and the box with the remainder of the items.

Use the following procedure if the quantity available in the location is lower than the task quantity:

- 1** When the system prompts to `Other Scan?`, specify No.  
The system prompts you to complete.
- 2** If the system prompts you to complete the picking tasks, choose one of the following:
  - a** Specify Yes.  
The system confirms the task with the actual quantity.
  - b** Specify No.  
The system confirms the task with the actual quantity and writes the task into history records. However, the task remains open with the remaining quantity to pick.
- 3** If the system prompts you to repick, choose one of the following:
  - a** Specify Yes.  
The system starts an on-line repick to locate missing quantities from the same location or another location.  
  
In batch picking, you can only see a new task once the picking process is complete. If the system selected an order because it has the highest priority, when you complete the current batch picking, the system displays the newly created repick task for the order on top of the RF selection list. The repick displays on top of the selection list because the repick is for the same high-priority order.
  - b** Specify No.  
You cannot repick for the order.
- 4** If the system prompts to fail the picking task, choose one of the following:
  - a** Specify Yes.  
The system fails the task and determines which fail option to present at the WLG level.  
The system changes the status of the source inventory to Fail. The Fail status is typically a non-available inventory status; therefore, the system no longer considers this specific inventory for picking.  
If Count on Fail is Yes, the system creates a recount task to recount stock in this location and assigns the task to the appropriate warehouse staff.
  - b** Specify No.  
The system does not fail the task and does not display fail options for the pick.

## Specifying a User Location as a Cart

Use Location Maintenance (80.3.13.1) to define a user location to temporarily store the stock on a cart until staff move stock to the shipping location. The user location represents the cart, which temporarily stores stock that staff have picked from the picking location. Before you can define a user location as a cart location, you must define the user in User Maintenance (80.11.13).

When staff pick an item and place it on a cart, the stock moves from the picking location to the user location. To reflect stock movement, AIM reduces the quantity in the picking location and increases the quantity in the user location. When staff confirm the batch pick, AIM:

- Moves the stock from the user location to the shipping location
- Reduces the quantity in the user location
- Increases the quantity in the shipping location

When a batch pick is not confirmed, the system returns stock from the user location back to the stocking location, thereby reducing user location quantities and increasing location quantities. Figure 11 shows which fields to set in Location Maintenance.

**Fig. 11** Location Maintenance (80.3.13.1)



*Location.* Specify the user ID of the picker you want to use as the cart location.

## New Local Exit Routines

Two new local exit routines were added to Local Exit Routine Control (80.24.23):

- Batch-picking order selection
- Batch-picking task sort

The batch-picking-order-selection exit routine lets users manipulate selected orders; for example, they can remove orders. The batch-picking-task-sort routine provides additional sort capabilities; for example, they can sort by weight.

## Fixes

- 1 The system now updates the container weight when items are added to the container. Previously, during batch picking, the system did not update the container weight.
- 2 If the system crashes or an RF user ends a session by pressing Ctrl+c, when the user logs in, the RF correctly displays the user's assigned tasks. This is applicable when the RF user works on a task in any of the following RF options:
  - Batch Pick-SO
  - Batch Pick-All
  - Work/Next Task
  - Work/Select Task
- 3 The system no longer displays a Progress error in the RF screen during batch picking when RF users choose the Select Task option with 0 (zero) priority tasks.
- 4 The system now validates reference data the RF user enters in the Reference field when batch picking. Previously, the system did not validate user entries in this field.

# Release Notes for Version 2.3a

**Advanced Inventory Management Version:** 2.3a

**MFG/PRO compatibility for 2.3a:** eB, initial release through Service Pack 5

eB2, initial release through Service Pack 5

**Supported languages:** US English, German, Castilian Spanish, Polish, Portuguese, Dutch, French

**Date:** October 15, 2004

**Installation Guide:** *Advanced Inventory Management* item 78-0628B

**User Guide:** *Advanced Inventory Management* item 78-0591B

## New Features

The following sections describe the most significant changes and fixes introduced with this version of AIM.

- 1 Batch-picking functionality was added to enhance picking tasks for radio data terminal (RDT) users. RDTs are also known as radio frequency (RF) devices. See “Batch Picking” on page 54.
- 2 A new Batch Picking Control File (80.15.24) was added to the Detail Picking Menu (80.15). See “Batch Picking Control Program” on page 58.
- 3 A new Program X-Reference (80.24.21.3) was added to cross reference standard MFG/PRO programs with programs you modify to work with AIM, for example, for localization purposes. The system places any records you enter into a new table named rund. See “Cross-Referencing Program Names” on page 62.
- 4 All hard-coded program names were removed from AIM. For a list of hard-coded programs, see “Hard-Coded Program Names” on page 63.
- 5 A default work location group (WLG) was added to the RF warehouse maintenance system. Previously, if you left the work location group (zone) that you are picking in blank, the system combined all work location groups associated with you as one work location group. A new user Work Loc Group (WLG) field was added to User-Work Location Group Maintenance (80.19.5). This field defines the WLG to which RF users belong and that they enter in the WLocGP field in the RF login screen. When RF users specify the default work location group in User-Work Location Group Maintenance, AIM only selects tasks corresponding to the WLG and for the task types assigned to the RF user.
- 6 Check digit functionality exists for warehouse staff when batch picking items from storage locations, if Check Digit is set to Yes in Storage Location Group Maintenance (80.3.1) and a check digit value is specified in Location Maintenance (80.3.13.1). Check digit functionality does not exist when moving items to containers during picking.

## Batch Picking

Batch picking lets warehouse staff pick items in a more efficient method. The time it takes to travel through the warehouse completing tasks at various locations, or the *travel sequence*, constitutes the largest amount of time involved when picking items from a warehouse. Batch-picking functionality reorders the order-picking sequence and tasks so that warehouse staff can pick multiple items from multiple orders at various locations throughout the warehouse with a shortened travel sequence.

Batch-picking functionality is applicable when picking the following:

- Small items with small values from multiple order lines
- Multi-bin items for a single order

Batch-picking functionality calculates the smallest difference in location from the warehouse staff's current location, letting them pick several small items from the same storage location for several different orders, then move to the next storage location nearest their current location to pick items from that location. For multi-bin orders, warehouse staff can build a pallet with large boxes of large items for one order with a shortened time sequence through the warehouse. You can also specify the maximum number of orders to pick.

Figure 12 depicts a warehouse with three work location groups (WLGs) and the dock where items are shipped. There are six locations (Loc 1 through Loc 6) in various areas of each WLG. Each location stores a finished good (FG 1 through FG 6).

**Fig. 12** Warehouse with WLGs

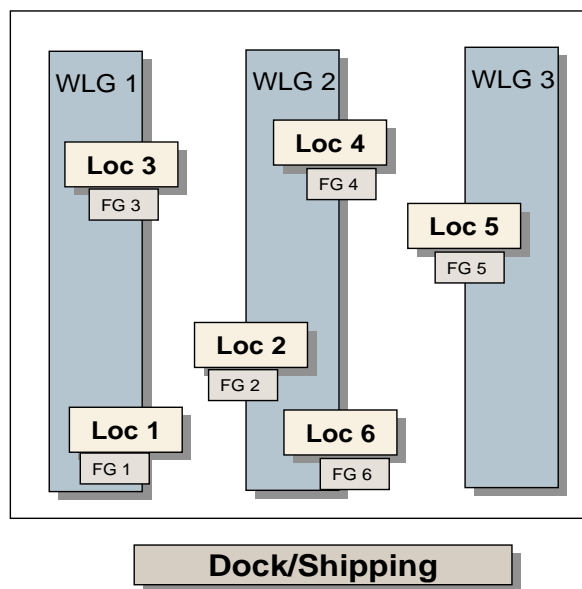

Without batch picking, warehouse staff pick the items for orders for their assigned tasks, making several trips to and from each location to the dock or shipping area. Figure 13 depicts nine tasks to pick items from six different locations.

Fig. 13 Picking Tasks

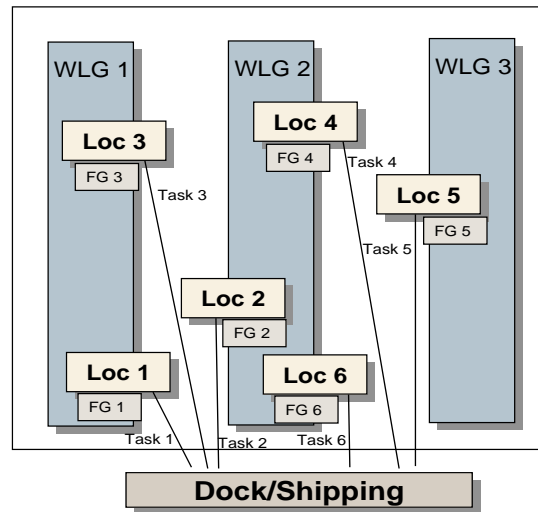

Batch-picking functionality reorders the order-picking sequence and tasks so that warehouse staff can pick the items for different orders with a shortened travel sequence, as shown in Figure 14.

Fig. 14 Reordered Travel Sequence

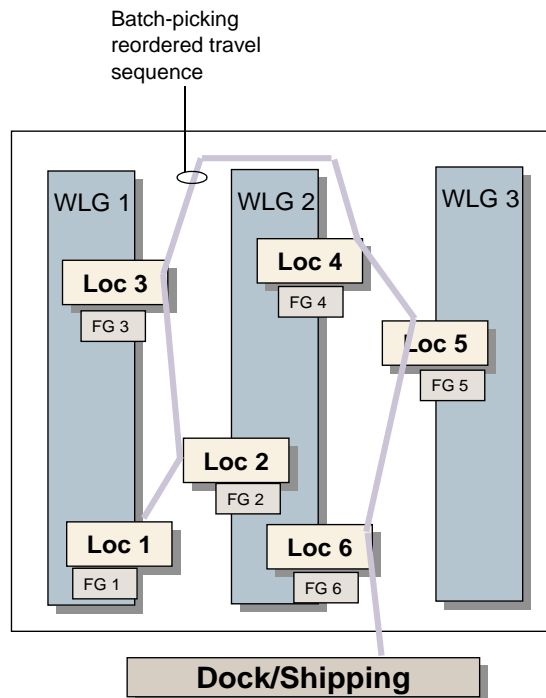

Unlike bulk picking, batch picking uses a *sort-by-pick* methodology. Warehouse staff can pick items from the same location for multiple orders while keeping the orders separated in different containers (boxes or totes) on their cart. Optionally, they can merge items for orders into a container, as long as orders use the same pre-shipper and you set control options to merge orders.

Figure 15 depicts a typical warehouse cart that staff use to pick orders. The cart contains six boxes for six separate orders. The RF device displays the pick tasks for the orders. Staff can scan either the location, item, lot/serial number, reference, or quantity picked from the location or scan the container—such as a box, tote, or pallet—that they pick to, depending on control settings.

**Fig. 15** Separated Orders During Pick

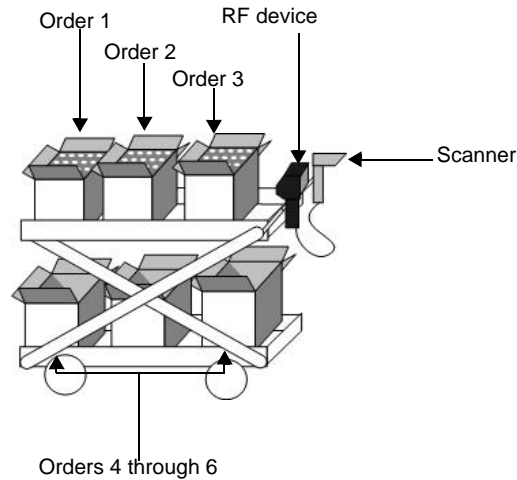

Batch picking lets RF users select and pick items from a mixed group of the following order types:

- Sales orders
- Work orders
- Distribution orders

When staff log onto the RF and specify their WLG, the RF lets them select orders from the following:

- Only sales orders
- All orders (work or distribution orders, or combinations of sales, work, and distribution orders)

Batch-picking functionality searches and reorganizes the tasks for the orders by:

- 1 Travel sequence, if defined
- 2 Location name in alphabetical order if no travel sequence is specified

**Note** Specify location names and define the travel sequence in Location Maintenance (80.3.13.1).

You can set control options so that the RF device displays picking tasks by order, customer, or pre-shipper.

At any time during the picking process, warehouse staff can press F3 in the RF to display the order picking status. AIM displays pick information per order, including the item number, the quantity already picked, and the quantity remaining to pick.

Order comments are visible for sales and distribution orders on the RF screen. If order header comments exist, warehouse staff can display the header comments by pressing F2. Once staff select a sales or distribution order, an asterisk displays beside the order number on the picking screen if order comments exist. Staff can press F2 on any field in the picking screen to view the order line comments.

**Note** For work orders, comments only exist at the header level, not at the line level.

Once warehouse staff complete all picks from the selection, the system directs them to the location where they transfer the reference.

Batch picking supports configured items.

#### Batch Picking Example

You have three sales orders with various quantities of six finished goods, located at six different locations. When you print the pre-shipper for the sales orders from within MFG/PRO, the system initiates AIM

batch-picking functionality. The picklist and tasks state that you have nine tasks to pick six different items FG1 through FG6 for the three orders as depicted in Figure 13. Table 2 lists the pick tasks for the three orders.

**Table 2** Tasks for Three Orders

Order	Qty	Item	Tasks
Order 1	3	FG1	1
	4	FG2	4
	2	FG3	2
Order 2	5	FG2	5
	2	FG3	3
	4	FG5	8
Order 3	1	FG5	9
	2	FG6	6
	2	FG4	7

There is a box needed per order. You set the reference as a box and the first box ID to start at ID 1285622. Table 3 shows how AIM reorders the tasks by location. The locations are now restructured to shorten the travel sequence, but actual picking of quantities and the orders themselves have not changed.

**Table 3** AIM Reordered Tasks

Location	Item	Qty	Order No	Box No.
Loc 1	FG1	3	Order 1	1285622
Loc 2	FG2	4	Order 1	1285622
	FG2	5	Order 2	1285623
Loc 3	FG3	2	Order 1	1285622
	FG3	2	Order 2	1285623
Loc 4	FG4	2	Order 3	1285624
Loc 5	FG5	4	Order 2	1285623
	FG5	1	Order 3	1285624
Loc 6	FG6	2	Order 3	1285624

### Batch Picking Control Program

For batch picking, you complete all setup tasks using a new Batch Picking Control File (80.15.24). Specify options in the program for determining settings such as order types, RF device, printing labels, displaying tasks, scanning during the pick tasks, and containers.

Figure 16 shows the Batch Picking Control program. Fields that relate to containers set options for the container into which staff place picked items, while fields that relate to scanning set options for the warehouse location and containers from which items are picked. Field explanations follow the figure.

Fig. 16 Batch Picking Control File (80.15.24)

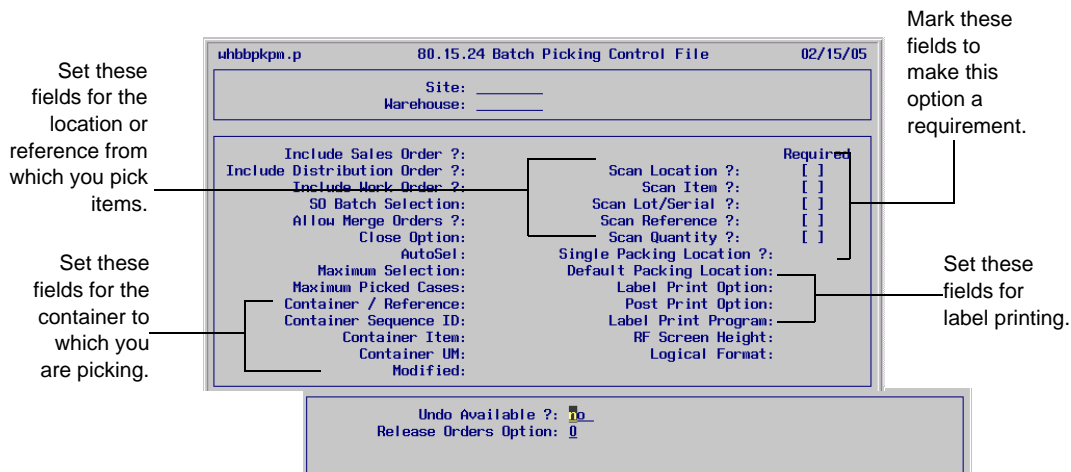

**Site.** Enter the site to use for batch picking.

**Warehouse.** Enter the warehouse to use for batch picking.

**Include Sales Order?** Indicate whether AIM includes sales orders for batch picking.

No: The system does not include sales orders for batch picking.

Yes: The system includes sales orders for batch picking. If you set this field to Yes, but set Include Distribution Order and Include Work Order to No, warehouse staff specify Batch Pick-SO from the RF selection screen to select only sales orders for picking. If distribution and work orders are included along with sales orders, staff specify Batch Pick-ALL from the RF selection screen. Sales orders display with an S preceding the order number.

**Include Distribution Order?** Indicate whether AIM includes distribution orders for batch picking.

No: The system does not include distribution orders for batch picking.

Yes: The system includes distribution orders for batch picking. Warehouse staff specify Batch Pick-ALL from the RF selection screen to select distribution orders. Distribution orders display with the letter D preceding the order number.

**Include Work Order?** Indicate whether AIM includes work orders for batch picking.

No: The system does not include work orders for batch picking.

Yes: The system includes work orders for batch picking. Warehouse staff specify Batch Pick-ALL from the RF selection screen to select work orders. Work orders display with the letter W preceding the order number.

**SO Batch Selection.** Indicate whether AIM displays customers, orders, or pre-shippers when selecting from the RF screen. The system displays the following options for this field at the bottom of the screen:

C=Customer O=Order P=Preshipper

The system validates your specification here against Generalized Codes Maintenance (36.2.13).

**Customer:** AIM displays customer IDs to select from in the RF screen. You define customers in Address Detail Maintenance (80.14.17).

**Order (the default):** AIM displays sales order numbers to select from in the RF screen. The system displays sales orders by priority, then due date. The system checks order priority in Sales Order Maintenance (80.14.3). The priority defaults from Address Detail Maintenance (80.14.17) when you create a new order. You can also manually update priority in Address Detail Maintenance by entering a date in the Priority field.

**Preshipper:** AIM displays pre-shipper numbers to select from in the RF screen. The priority defaults from the Priority field in Address Detail Maintenance (80.14.17).

**Allow Merge Orders.** Indicate whether warehouse staff can combine items from different orders into containers. The items can be from separate orders but must have the same pre-shipper.

No: Do not combine items from different orders into the same container.

Yes: Combine items from different orders and the same pre-shipper into the same container.

**AutoSel.** Indicate whether or not AIM automatically selects orders with the highest priority.

No (the default): Warehouse staff can select orders for batch picking.

Yes: AIM selects orders with the highest priority for picking. The orders are marked with an asterisk (\*) on the RF screen. Staff must pick for orders in the order that they display on the RF; they cannot scroll to the bottom of the list or skip orders.

**Maximum Selection.** Enter the maximum number of sales orders, pre-shippers, or customers that can be grouped for one picking session. The system displays the orders with the highest priority.

**Maximum Picked Cases.** Enter the maximum number of cartons/totes/boxes that warehouse staff can pick at the same time. You cannot leave this field blank. This number typically depends on the capacity of the cart. When selecting orders from the RF, staff cannot select more orders, customers, or pre-shippers than the maximum number of picked cases.

**Container/Reference.** Specify whether to pick to a container or enter the container reference number. When batch picking for multiple orders, the containers are typically boxes or totes. When batch picking for multi-bin orders, the containers are typically pallets. Containers apply to sales orders, while reference applies to distribution and work orders.

Container: Pick items to a container. This option is only applicable to sales orders. Typically, warehouse staff scan the containers to register the container with the system. For sales orders that are picked for the first time, the default is blank. Once the container is scanned, that container ID is the default for each subsequent task.

Reference: Enter the reference ID at the RF device, such as the box, tote, or pallet ID. This option is always for distribution and work orders because containerization is not available for these order types.

**Container Sequence ID.** Enter the starting sequence ID for box/tote/container numbers. You specify the sequence IDs in Sequence Definition Maintenance (80.24.1).

**Container Item.** Enter the item number of the container.

**Container UM.** Enter the unit of measure for the container. For example, if batch picking multi-bin items to a pallet, enter the pallet ID as the UM.

**Modified.** This field is display only and depicts the date that control values were last modified and the user who modified them.

**Scan Location?** Indicate whether to scan the location from which items are picked.

No: Do not scan the location label or barcode from which items are picked.

Yes: Warehouse staff can access the Location field on the RF and scan. To make scanning mandatory, mark the Required field next to the scan option field.

**Note** Pressing Enter while in the Required field selects or deselects the requirement.

**Scan Item?** Indicate whether to scan the item being picked.

No: Do not scan the item when picking.

Yes: Warehouse staff can access the Item field on the RF and scan. To make scanning mandatory, mark the Required field next to the scan option field.

*Scan Lot/Serial?* Indicate whether to scan the lot/serial number for the picking location.

No: Do not scan the lot/serial number when picking.

Yes: Warehouse staff can access the Lot/Serial field on the RF and scan. To make scanning mandatory, mark the Required field next to the scan option field.

*Scan Reference?* Indicate whether to scan the destination reference when picking.

No: Do not scan the reference ID when picking.

Yes: Warehouse staff can access the Reference field on the RF and scan. To make scanning mandatory, mark the Required field next to the scan option field.

*Scan Quantity?* Indicate whether to scan the quantity picked.

No: Do not scan the quantity picked.

Yes: Warehouse staff can access the Quantity field and scan. To make scanning mandatory, mark the Required field next to the scan option field.

*Single Packing Location.* Indicate whether batch-picked items are for a single-packing location. For example, if you use a single-shipping location as the packing location, set this option to Yes. Locations are defined in AIM Location Maintenance (80.3.13.1). Specify a default packing location in Default Packing Location.

No: There are multiple packing locations.

Yes: There is a single packing location. The system eliminates an RF screen since all picks from all references go to the same destination. Once picking tasks are complete and confirmed as completed, the RF screen displays the selection screen with the default location in the To Location field.

*Default Packing Location.* Specify a default packing location. Locations are defined in AIM Location Maintenance (80.3.13.1)

*Label Print Option.* Indicate whether labels print automatically, not at all, or if the system prompts to print labels after the order selection is complete but before picking begins. You must specify the print program in Label Print Program. The system prints UCC128/EAN128-format labels for cases, empty boxes, or totes that do not already have a label. Use the look-up browse to select an option.

0: Never print labels at the end of picking.

1: Always print labels at the end of picking.

2: Prompt RF user to print labels at the end of picking.

**Note** To specify printing after picking, set Postprint Option to Yes.

Printing before picking is useful when staff perform multiple order picking. Warehouse staff can print labels for containers, scan the labels, then use the scanned data to ensure that each order is put into the right container. Use the look-up browse to select an option.

*Postprint Option.* Indicate whether labels print automatically after picking, not at all, or if the system prompts to postprint labels.

0: Never postprint labels.

1: Always postprint labels.

2: Prompt to postprint labels.

Printing after picking—postprinting—is useful when warehouse staff know the exact contents of the box, tote, or pallet to which they picked items. If you use batch picking for multi-bin pickup with only one pallet, staff typically use post-printed labels, not preprinted labels.

**Label Print Program.** Specify the print program to use when printing labels. AIM ships with the `whpripkz.p` print program, which is Loftware-format compatible. You can edit `whpripkz.p`, using a standard text editor; rename the program; then, enter it here.

**Close Option.** Indicate whether to close containers when they are full and release the order. Use the look-up/browse to select a close option.

0: Never Release Order. The system closes the pick. All other tasks associated with the order, customer, or pre-shipper are not dependent upon completing the pick task. Warehouse staff cannot open a new tote or box during the current pick, but can continue picking for the order later.

1: Always Release Order. New boxes or totes can be created to replace a box or tote that is full. The system prints a new label for the new box or tote, depending upon Label Print Option and Postprint Option settings.

2: Prompt for Releasing Order. The system prompts to release the order.

**RF Screen Height.** Specify the number of lines that display on the RF screen. The default is 0 (zero); however, for RF screen readability, enter a number between 6 and 20.

**Logical Format.** Indicate whether RF users enter logical values 1/0 or Yes/No. Yes/No is applicable to RF devices that have a keyboard.

This field is mandatory. Enter the forward slash (/) with either the 1/0 or Yes/No. The system treats the value preceding the slash as positive, and the value following the slash as negative.

**Note** Entering characters without the slash can cause errors in interpretation. For example, if RF users specify 10, the system interprets the number 10 as negative.

1/0: RF users can enter the number 1 for positive and 0 (zero) for negative responses.

Yes/No: RF users can type Yes or No on the keypad.

**Undo Available.** Indicate whether the system prompts to undo picking tasks and leave the batch picking process on the RF when the RF user presses cancel (F4) during picking.

No: RF users are not prompted to undo tasks and leave picking functions after they press cancel.

Yes: If RF users press cancel on the RF screen during picking, the system first displays a prompt to exit the process. If the user specifies Yes, the system displays a prompt to undo and leave picking tasks. If Yes, the system rolls back all completed picks and sets pick tasks to unassigned. Upon exiting the picking process, the system sets confirmed to No or 0 (zero).

**Note** RF use of Yes/No or 1/0 depends upon control settings.

## Cross-Referencing Program Names

If you customize program names, for example, for localization purposes, use Program X-Reference Maintenance (80.24.21.3) to cross-reference MFG/PRO program names with your customized program names. Figure 17 depicts the Program X-Reference Maintenance screen.

Fig. 17 Program X-Reference Maintenance (80.24.21.3)

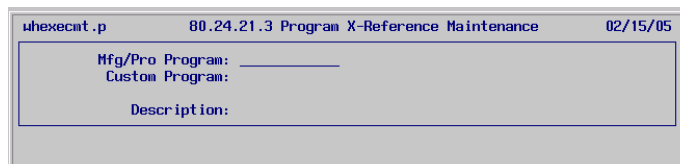

The screenshot shows a terminal window with the following content:

```
whexecut.p      80.24.21.3 Program X-Reference Maintenance      02/15/05
Mfg/Pro Program: _____
Custom Program:  _____
Description:     _____
```

**MFG/PRO Program.** Enter the name of the MFG/PRO program that you customized.

**Custom Program.** Enter the new name of the customized program.

*Description.* Enter a short description of the cross-referenced programs.

## Hard-Coded Program Names

Some AIM triggers were based on program names that were hard coded within some AIM programs. With AIM 2.3, program names are no longer hard-coded. Table 4 lists eB (91) programs with hard-coded names:

**Table 4** eB Programs with Hard-Coded Names

chr/aimsrc/cpdtrig.p	chr/aimsrc/whenckpk.p
chr/aimsrc/whexecmt.p	chr/aimsrc/whextask.i
chr/aimsrc/whgptric.i	chr/aimsrc/whgptrrf.i
chr/aimsrc/whiccccl.p	chr/aimsrc/whicedai.i
chr/aimsrc/whicladd.i	chr/aimsrc/whicldd.i
chr/aimsrc/whicldw.i	chr/aimsrc/whlidd.p
chr/aimsrc/whldw.p	chr/aimsrc/whlmupd1.i
chr/aimsrc/whmfgexe.i	chr/aimsrc/whmupd1.i
chr/aimsrc/whomcred.i	chr/aimsrc/whomsobw.i
chr/aimsrc/whomsodw.i	chr/aimsrc/whomwow.i
chr/aimsrc/whpklad.p	chr/aimsrc/whpklev.i
chr/aimsrc/whprida.i	chr/aimsrc/whprparm.p
chr/aimsrc/whprtfa.i	chr/aimsrc/whrpauto.i
chr/aimsrc/whrundd.t	chr/aimsrc/whtrclip.i
chr/aimsrc/whtrclm3.p	chr/aimsrc/whtrw.p
chr/aimsrc/whumrfip.i	chr/aimsrc/whwindob.i
chr/qadsrceB/ir/icsrup2.p	chr/qadsrceB/ir/icsrup.p
chr/qadsrceB/ir/whsisl01.p	chr/qadsrceB/ir/sosob1.p
chr/qadsrceB/sp1/icsrup2.p	chr/qadsrceB/sp1/icsrup.p
chr/qadsrceB/sp1/whsisl01.p	chr/qadsrceB/sp1/sosob1.p
chr/qadsrceB/sp2/icsrup2.p	chr/qadsrceB/sp2/icsrup.p
chr/qadsrceB/sp2/whsisl01.p	chr/qadsrceB/sp2/sosob1.p
chr/qadsrceB/sp3/icsrup2.p	chr/qadsrceB/sp3/icsrup.p
chr/qadsrceB/sp3/whsisl01.p	chr/qadsrceB/sp3/sosob1.p
chr/qadsrceB/sp4/icsrup2.p	chr/qadsrceB/sp4/icsrup.p
chr/qadsrceB/sp4/whsisl01.p	chr/qadsrceB/sp4/sosob1.p
chr/qadsrceB/sp5/icsrup2.p	chr/qadsrceB/sp5/icsrup.p
chr/qadsrceB/sp5/whsisl01.p	chr/qadsrceB/sp5/sosob1.p
install/compile/aim.wrk	install/data/aim/rund.d

Table 5 lists eB2 programs with hard-coded names.

**Table 5** eB2 Programs with Hard-Coded Names

chr/qadsrceB2/ir/icsrup.p	chr/qadsrceB2/ir/icsrup2.p
chr/qadsrceB2/ir/sosob1.p	chr/qadsrceB2/ir/whsisl01.p
chr/qadsrceB2/sp1/icsrup.p	chr/qadsrceB2/sp1/icsrup2.p
chr/qadsrceB2/sp1/sosob1.p	chr/qadsrceB2/sp1/whsisl01.p
chr/qadsrceB2/sp2/icsrup.p	chr/qadsrceB2/sp2/icsrup2.p
chr/qadsrceB2/sp2/sosob1.p	chr/qadsrceB2/sp2/whsisl01.p
chr/qadsrceB2/sp3/icsrup.p	chr/qadsrceB2/sp3/icsrup2.p

chr/qadsrc/eB2/sp3/sosob1.p	chr/qadsrc/eB2/sp3/whsisl01.p
chr/qadsrc/eB2/sp4/icsrup.	chr/qadsrc/eB2/sp4/icsrup2.p
chr/qadsrc/eB2/sp4/sosob1.p	chr/qadsrc/eB2/sp4/whsisl01.p
chr/qadsrc/eB2/sp5/icsrup.p	chr/qadsrc/eB2/sp5/icsrup2.p
chr/qadsrc/eB2/sp5/sosob1.p	chr/qadsrc/eB2/sp5/whsisl01.p

## Fixes

- 1 Tasks are filtered correctly now. You no longer see tasks:
  - In the Next Task frame if you are not assigned to the task type or assigned to the work location group (WLG)
  - If the task has a 0 (zero) priority.

**Note** The higher the number, the higher the priority.
- 2 The cancel function (F4) is disabled now while RF users confirm picking tasks. Previously, the cancel function was not disabled and RF users could inadvertently cancel picked items while attempting to cancel an RF screen.

## Release Notes for Version 2.2a and SSD 2.2.a

**Advanced Inventory Management Versions:** 2.2a and SSD 2.2a

**MFG/PRO Compatibility for 2.2a:** 9.0, initial release through Service Pack 5  
eB, initial release through Service Pack 5  
eB2, initial release through Service Pack 5

**MFG/PRO Compatibility for SSD 2.2a:** eB2.1 initial release

**Supported Languages:** US English, German, Castilian Spanish, Polish, Portuguese, Dutch, French

**Date:** May 15, 2004

**Installation Guide:** *Advanced Inventory Management* item 78-0628A

**User Guide:** *Advanced Inventory Management* item 78-0591B

### New Features for MFG/PRO eB2

#### Support for Supplier Consignment

AIM 2.2a now provides support for the Supplier Consignment module released with MFG/PRO eB2.

Implementing AIM with Supplier Consignment requires a few additional setup tasks.

#### Consignment Receipt

You must set up new transaction types for consignment in Internal Routing Assignment Maintenance (80.2.9) and Algorithm Assignment Maintenance (80.6.9).

See Chapter 3 and Chapter 8 of *User Guide: Advanced Inventory Management* for additional details.

The transaction types are:

CN-RCT. This transaction records a purchase order receipt of consigned inventory.

INSP-CN. Use this transaction to route consigned inventory (received with the CN-RCT transaction) to inspection.

BACK-CN. Use this transaction to move consigned inventory to the main storage area after inspection.

FAIL-CN. Use this transaction to move consigned inventory to the reject area when the inspection fails.

#### Transfer Ownership

Supplier Consignment added a new Transfer Ownership field to Site Maintenance (1.1.13) and Location Maintenance (1.1.18) in MFG/PRO. At the location level, this field determines whether inventory received into the location retains its consigned status or receipt initiates a transfer of ownership.

This same field has been added to AIM Location Maintenance (80.3.13.1) and Mass Location Maintenance (80.3.13.21) where it has the same effect. See *User Guide Volume 2B: Distribution* for details on Supplier Consignment.

## Customer Consignment

AIM now supports the Customer Consignment module introduced in MFG/PRO eB2. No special setup is required to manage customer consigned inventory in AIM.

## New Picking Algorithms

Eight new picking algorithms have been added to AIM to give you increased control over how consignment stock is picked:

Algorithm	Description
61	Pick by Location Consignment Stock Only
62	Pick by Lot/Serial Consignment Stock Only
63	Pick by Date Consignment Stock Only
64	Pick by Expiration Date Consignment Stock Only
65	Pick by Location Nonconsignment Stock Only
66	Pick by Lot/Serial Nonconsignment Stock Only
67	Pick by Date Nonconsignment Stock Only
68	Pick by Expiration Date Nonconsignment Stock Only

See Chapter 8 of *User Guide: Advanced Inventory Management* for additional details on setting up algorithms.

**Note** The setting of Use Consignment First in Supplier Consignment Control (5.18.24) determines if consignment transactions are created when a stock record includes both consigned and nonconsigned inventory.

## New Features for All Versions

### Distribution Orders

Previous releases of AIM supported distribution order receipt and picking. AIM 2.2a extends the support for distribution order receipts.

### Receiving Location

When a new intersite request is created, the default receipt location is the location associated with the item at the receiving site in Item Master Maintenance (1.4.1). AIM now verifies if the default value is a master list, warehouse, or a location that belongs to the receiving site. If this is not true, AIM uses the value specified for Site Location in AIM Item-Site Maintenance (80.4.9). This lets you set up AIM-specific default receipt locations for each site.

### References Created During Receipt

When you receive orders with Distribution Order Receipt (12.15.20), the system now automatically creates references for items set up as being received in a different unit of measure. See Chapter 12 of *User Guide: Advanced Inventory Management* for details about this kind of receipt.

**Note** This only occurs when the inventory in transit from the supplying site does not contain reference numbers.

## Check Digit Generation

A new Check Digit Generation (80.3.13.13) program lets users create check digits for all locations of a given warehouse. The check digit can be from 1 to 8 alphanumeric characters. The system generates the check digits randomly. This function is useful for warehouses that are not managed with radio- frequency devices to ensure that the correct locations are being referenced during picking.

## Transactions by WLG Report (80.9.11)

For companies that manage tasks with paper-based systems rather than radio-frequency (RF) devices, the new Transactions by WLG Report (80.9.11) lists all open transactions sorted by work location group (WLG). Previously, users had to print each task on its own page.

## Fixes

- 1 AIM transactions are now deleted when distribution orders are unpicked. Previously, they were left in the system.
- 2 The picking simulation programs (80.6.21.4 and 80.6.21.5) no longer ignore lot and reference numbers.
- 3 RF On-the-Fly Transfer previously would not allow you to transfer the unallocated quantity of a partially allocated inventory record. This has been changed to allow the unallocated quantity to be available for transfer.
- 4 A compilation error for 63k code size has been fixed.
- 5 Users can now increase and decrease quantities in RF Transfer through Internal Routing Maintenance (80.2.5).
- 6 Multiple item/lot pallet putaway no longer splits tasks for different items.
- 7 Users can now run a kanban scan using an RF device.
- 8 During Shipper Confirm (7.9.5), AIM now checks for open tasks for finished items and configured items. Previously, configured items were being ignored.
- 9 Users can now manually create references based on the UM conversion even when an item is not set up as a reference item in AIM.
- 10 A Progress error that occurred during Transfer Single Item (80.17.4) has been corrected.
- 11 AIM now correctly deletes open tasks when the status of a work order is changed from Release in Work Order Maintenance (16.1).
- 12 The Multi-Entry field now works correctly for non-US English versions of AIM.
- 13 The default location defined for call reports created in Call Activity Recording (11.1.1.13) in Service/Support Management is no longer overwritten by AIM. If the location on the call report is an AIM master list, it is processed correctly by AIM.
- 14 AIM has a setting to ensure that a customer is never shipped an item with an expiration date that is earlier than a previous shipment. A problem with this setting has been fixed so that it now works correctly.
- 15 A mismatched parameter error was fixed for the MFG/PRO eB2 release in SO Picking Statistics and Management (80.15.1).

- 16 The error “No SLGM Record is available” was being displayed when using algorithm 151 during simulations and detail picking. This error was incorrect and has now been corrected.