



QAD Enterprise Applications
Enterprise Edition

Technical Reference **Life Sciences Process Maps**

78-0777A
QAD 2009 Enterprise Edition
Life Sciences Process Maps
April 2009

This document contains proprietary information that is protected by copyright and other intellectual property laws. No part of this document may be reproduced, translated, or modified without the prior written consent of QAD Inc. The information contained in this document is subject to change without notice.

QAD Inc. provides this material as is and makes no warranty of any kind, expressed or implied, including, but not limited to, the implied warranties of merchantability and fitness for a particular purpose. QAD Inc. shall not be liable for errors contained herein or for incidental or consequential damages (including lost profits) in connection with the furnishing, performance, or use of this material whether based on warranty, contract, or other legal theory.

QAD and MFG/PRO are registered trademarks of QAD Inc. The QAD logo is a trademark of QAD Inc.

Designations used by other companies to distinguish their products are often claimed as trademarks. In this document, the product names appear in initial capital or all capital letters. Contact the appropriate companies for more information regarding trademarks and registration.

Copyright ©2008 by QAD Inc.

QAD Inc.

100 Innovation Place
Santa Barbara, California 93108
Phone (805) 684-6614
Fax (805) 684-1890
<http://www.qad.com>

Contents

- About This Guide 1**
 - Other QAD Documentation 2
 - Online Help 2
 - QAD Web Site 3
 - Conventions 3
 - Screen Illustrations 3
 - Typographic 4

- Chapter 1 Process Map Guidelines 5**
 - Overview 6
 - Process Map Views 6
 - Editing Process Maps 8
 - Map Filenames 8
 - Map Titles 10
 - Level 1 10
 - Level 2 11
 - Lowest Level 13
 - Nodes 14
 - Linking Nodes to Maps and UI Objects 15
 - Layout 17
 - Arrows and Connectors 17
 - Arrows 18
 - Connectors 18
 - Creating or Modifying Process Maps 19

Chapter 2 Top-Level Process Maps	21
Supply Chain Process Model	22
Collaborate Using QAD SV	23
Vertical Industry Process Model	24
Chapter 3 Set Up to Run Process Maps	25
Life Sciences Top Level	26
Set Up to Run Top Level	28
Set Up Manager Functions (EF)	30
Create Databases (EF)	32
Configure Databases (EF)	34
Set Up Currencies and Countries (EF)	36
Set Up Other Geographical Data (EF)	38
Set Up Other General Data (EF)	40
Create Address for Internal Entities (EF)	42
Set Up Corporate Structure (EF)	44
Set Up Security (EF)	46
Set Up Accounts and Controls (EF)	48
Set Up General Ledger (EF)	50
Set Up Daybooks (EF)	52
Set Up Charts of Account Structure	54
Set Up SAFS	56
Set Up GL Mask	58
Set Up Structured Reports	60
Define GL Calendar	62
Set Up Layers	64
Set Up Operational Accounting Controls	66

Set Up Allocations (EF)	68
Set Up Financial Allocations	70
Set Up Audit Trails	72
Set Up Multiple Currency	74
Set Up Consolidation	76
Set Up Fixed Assets	78
Set Up Items and Sites	80
Set Up Sites	82
Set Up Site Security	84
Layout Warehouse	86
Create Warehouse	88
Create Warehouse Definitions	90
Define Items	92
Set Up Terms and Taxes	94
Enter Terms and Taxes	96
Set Up Freight Lists	98
Define Business Partners (EF)	100
Define Customers	102
Define Suppliers (EF)	104
Define Salespersons (EF)	106
Define Employees (EF)	108
Set Up Business Relationships	110
Set Up Distribution Networks	112
Set Up Enterprise Material Transfer	114
Set Up EDI Trade Maps	116
Set Up Transportation Management	118
Set Up Supplier Schedules	120

Set Up Customer Consigned Inventory	122
Set Up Supplier Consigned Inventory	124
Set Up Shipping Groups	126

Chapter 4 Design To Release Process Maps 127

Life Sciences Top Level	128
Design To Release Top Level	130
Initiate New Product Development	132
Define Work Centers	134
Define Products and Processes	136
Create Bills of Material	138
Define Features and Options	140
Set Up QAD Configurator	142
Define Routings	144
Define Formulas and Processes	146
Define Production Lines	148
Operator Balancing	150
Define Manufacturing Systems	152
Define Specifications and Procedures	154
Set Up WIP Lot Trace	156
Establish Product Costs	158
Update Product Costs	160
Implement Extended Costing	162
Simulate Cost Changes	164
Set Up Purchase Order Price Lists	166

Chapter 5 Opportunity to Quote Process Maps 169

Life Sciences Top Level 170
Opportunity To Quote Top Level 172
Establish Product Prices 174
Set Up Purchase Order Price Lists 176
Setup Sales Order Price Lists 178
Manage Marketing Campaigns 180
Process Sales Quotes 182

Chapter 6 Order to Cash Process Maps 185

Life Sciences Top Level 186
Order to Cash Top Level 188
Plan 190
Enter Shipments and Orders 192
Enter Production, Inventory, and Backlog 194
Reconcile Plans with Company Goals 196
Set Up Operations Planning 198
Load Data 200
Plan Families 202
Plan End Items 204
Reconcile Detailed Forecasts with S&OP Demand 206
Create Master Production Schedule 208
Forecast Demand 210
Forecast Sales 212
Schedule 214
Schedule Purchase Orders 216
Schedule Discrete Orders 218

Create Capacity Plan	220
Schedule Lean Manufacturing	222
Schedule Intersite Requests	224
Process Distribution Orders	226
Order	228
Process Sales Quotes	230
Process Sales Orders	232
Produce Product	234
Repetitive	236
Issue Repetitive Picklist	236
Make On Repetitive Line	238
Manage Subcontract Purchasing	240
Inspect Product In-Line	242
Discrete	244
Issue Discrete Order	244
Pick Items	246
Use Batch Picking	248
Use Wave Picking	250
Make to Discrete Order	252
Inspect Product (End-of-Line)	254
Monitor Production	256
Ship Product	258
Pack and Ship Items	260
Process Distribution Orders	262
Process Sales Order Shipments	264
Process Shippers	266
Collect From Customer (EF)	268

Receive Return From Customer	270
Invoice Customers (EF)	272
Process Receivables (EF)	274
Collect Receivables (EF)	276

Chapter 7 Procure to Pay Process Maps..... 277

Life Sciences Top Level	278
Procure to Pay Top Level	280
Place Supply Order	282
Set Up Purchase Requisitioning	284
Place Purchase Requisition	286
Place Discrete Purchase Order	288
Receive Materials	290
Standard Inventory Management	292
Receive Purchase Orders	292
Inspect Receipts from Supplier	294
Return to Supplier	296
Receive Distribution Orders	298
Advanced Inventory Management	300
Receive Items	300
Put Items Away	302
Monitor Warehouse Labor	304
Pay Supplier	306
Process Vouchers (EF)	308
ERS Processing	310
Manage Fixed Assets	312

Chapter 8 Measure Results Process Maps	313
Life Sciences Top Level	314
Measure Results Top Level	316
Manage Cycle Counts	318
Manage Physical Inventory	320
Manage Fixed Assets	322
Use Enterprise Financials	324
Manage Budgets	326
Allocate Costs	328
Use Banking	330
Use Petty Cash	332
Process Transactions	334
Post Journal Entries	336
Post Recurring Entries	338
Intercompany Transactions	340
Revaluation	342
Set Up Revaluation	344
Reverse Journal Entries	346
Cross-Company Transactions	348
Open Item Adjustment	350
Run Allocations	352
Mirror Accounting	354
Set Up Mirror Accounting	356
Create Templates	358
Layer Transfer	360
Year-End Closing	362
Set Up Year-End Closing	364

Perform Year-End Closing Checks	366
Close Period End	368
Consolidate General Ledgers	370



About This Guide

Other QAD Documentation 2

Online Help 2

QAD Web Site 3

Conventions 3

This guide lists the Automotive process maps included with QAD Enterprise Applications – Enterprise Edition.

Other QAD Documentation

- For an overview of new features and software updates, see the *Release Bulletin*.
- For software installation instructions, refer to the appropriate installation guide for your system.
- For conversion information, refer to the *Conversion Guide*.
- For an overview of system features and instructions on navigating the user interface, see *User Guide: QAD User Interfaces*.
- For detailed information on using system features, refer to the relevant user guide.
- For technical details, refer to *Entity Diagrams* and *Database Definitions*.

For a complete list of QAD Documentation, visit the QAD Online Support Center at:

<http://support.qad.com/>

Online Help

There is an extensive online help system. Help is available for most fields found on a screen. Procedure help is available for most programs that update the database. Most inquiries, reports, and browses do not have procedure help.

For information on using the help system in the different environments, refer to *User Guide: QAD User Interfaces*.

QAD Web Site

The QAD Web site provides a wide variety of information about the company and its products. You can access the Web site at:

<http://www.qad.com>

For users with a QAD Web account, product documentation is available for viewing or downloading from the QAD Online Support Center at:

<http://support.qad.com/>

You can register for a QAD Web account by accessing the Web site. Your customer ID number is required. Access to certain areas is dependent on the type of agreement you have with QAD.

Most user documentation is available in two formats:

- Portable document format (PDF) files can be downloaded from the QAD Web site to your computer. You can view and print them with the free Adobe Acrobat Reader.
- HTML files let you view user documentation through your Web browser and use search tools for easily locating topics of interest.

Conventions

Screen Illustrations

System functions are available in a feature-rich .NET-based graphical user interface (UI); a subset of functions can be used in a simplified character interface. All screenshots in the documentation show the .NET UI.

Navigation in the two UIs is not the same. The user guide text follows the navigation model of the .NET UI for moving from one screen to the next. In the character interface, the Progress status line at the bottom of a program window lists the main UI-specific keyboard commands used in that program. In the .NET UI, alternate commands are listed in the Actions menu.

For complete keyboard command summaries for UI navigation, refer to the appropriate chapters of *User Guide: QAD User Interfaces*.

Typographic

This document uses the text or typographic conventions listed in the following table.

If you see:	It means:
monospaced text	A command or file name.
<i>italicized</i> monospaced text	A variable name for a value you enter as part of an operating system command; for example, <i>YourCDROMDir</i> .
indented command line	A long command that you enter as one line, although it appears in the text as two lines.
Note	Alerts the reader to exceptions or special conditions.
Important	Alerts the reader to critical information.
Warning	Used in situations where you can overwrite or corrupt data, unless you follow the instructions.

Process Map Guidelines

The following topics provide guidelines on working with QAD process maps.

Overview **6**

Process Map Views **6**

Map Filenames **8**

Map Titles **10**

Nodes **14**

Layout **17**

Arrows and Connectors **17**

Creating or Modifying Process Maps **19**

Overview

Process maps are graphical models of workflows that link to programs, browses, and other process maps. You can view, edit, and create process maps in the QAD .NET User Interface using the Process Viewer and Process Editor. The QAD .NET User Interface stores process maps in XML files. This technical reference lists the process maps for QAD Enterprise Applications – Enterprise Edition.

This chapter provides some guidelines for using, creating, and editing process maps in QAD applications.

Note For detailed information on editing process maps, refer to *User Guide: QAD 2008 User Interfaces*.

Process maps illustrate the principal business and operational processes within a QAD application, and consequently, provide graphical navigation. A process is a structured set of activities designed to accomplish a specific objective.

Process Map Views

There are two separate views for process maps in QAD applications: the Vertical Industry View and the Supply Chain View. Both views lead to the same detailed maps.

When you create a new process map, you must link it to the appropriate hierarchy in both views to make it accessible to users.

Fig. 1.1
Vertical Industry View

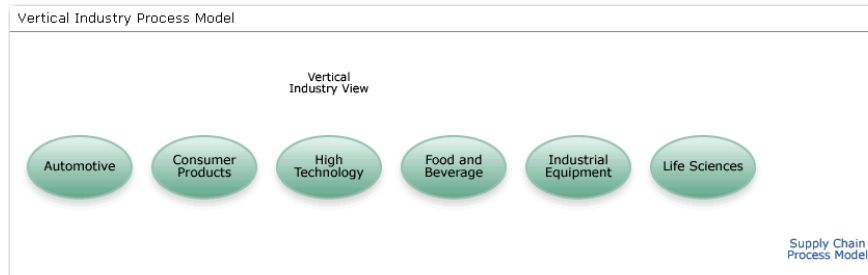

Fig. 1.2
Supply Chain View



Editing Process Maps

You can edit the process maps published by QAD using the Process Map Editor. You can access the Process Map Editor using the Edit Process button in the toolbar.

Fig. 1.3
Edit Process Button

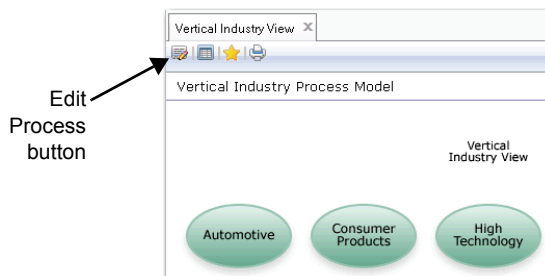

Note The process map files you draw in the Process Map Editor are generated as .xml files

Map Filenames

The process maps published by QAD are identified by two pieces of information: an alphanumeric name, which is also the process map filename, and a title, which is displayed on the process map breadcrumb.

Fig. 1.4
Process Editor with Names
and Titles

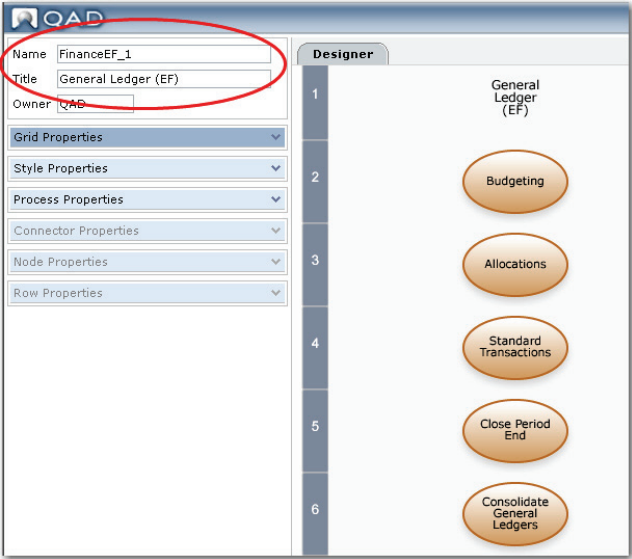

Note The title will not appear on the actual process map. You must enter the title as a Text node for it to appear on the process map.

Fig. 1.5
Process Map Editor Browse

	Name ^	Title	Owner	Last Modified
149	<input type="checkbox"/> Deliver_3_4	Process Shippers	QAD	Thu Jun 12 2008 00:37:11 BST
150	<input type="checkbox"/> Deliver_3_5	Ship Sequenced Orders	QAD	Fri Jun 20 2008 20:46:09 BST
151	<input type="checkbox"/> Deliver_3_6	Monitor Shipment Performance	QAD	Mon Jun 16 2008 21:48:25 BST
152	<input type="checkbox"/> Deliver_4_1	Process Sequenced Orders	QAD	Tue Jan 29 2008 05:35:10 GMT
153	<input type="checkbox"/> Deliver_4_1Template	Ship Sequenced Orders	QAD	Tue Jun 10 2008 21:26:38 BST
154	<input type="checkbox"/> Deliver_5_1	Ship Product	QAD	Thu Nov 15 2007 20:51:40 GMT
155	<input type="checkbox"/> Deliver_6	Customer Consigned Inventory	pma	Wed Jun 11 2008 05:17:47 BST

All QAD process maps begin with a code that identifies the functional area to which the map belongs, followed by a number that indicates the map's place within the map hierarchy for that area. For example, the first map in the Automotive area is named Auto_1.

If Auto_1 opens four sub-maps, they would be named Auto_1_1, Auto_1_2, Auto_1_3, and Auto_1_4. If two maps open from Auto_1_2, they are named Auto_1_2_1 and Auto_1_2_2. If two maps open from Auto_1_2_1, they are named Auto_1_2_1_1 and Auto_1_2_1_2.

Fig. 1.6
Map Naming Hierarchy

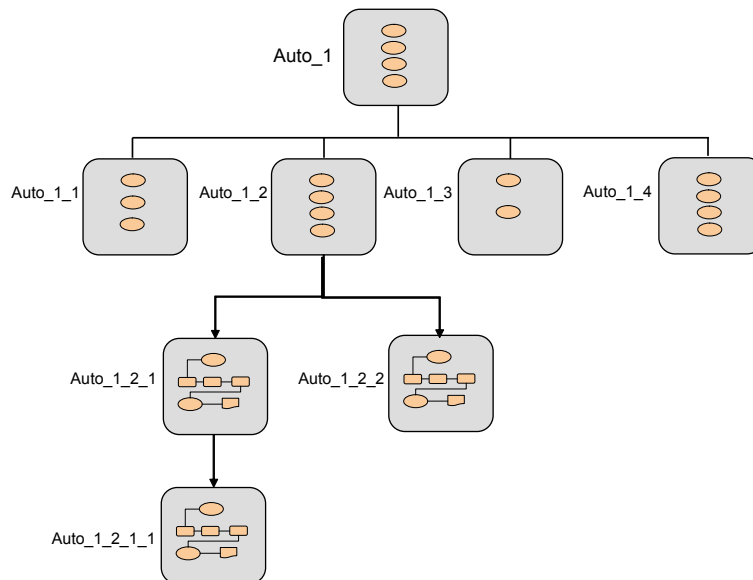

Map Titles

Level 1

When you click on a high-level node, you open a high-level vertical map for that functional area.

Fig. 1.7
Level 1 Title

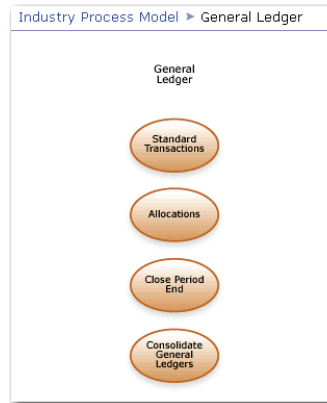

The titles of level 1 maps are located above the maps, and are printed in black text.

Level 2

When you click on a node in the level 1 map, you open a subsequent process map vertical for that area, or a more detailed process flow.

If Level 2 of the map hierarchy consists of another vertical menu, the title of the menu is located above the map in black text, like a level 1 title.

Fig. 1.8
Level 2 Title

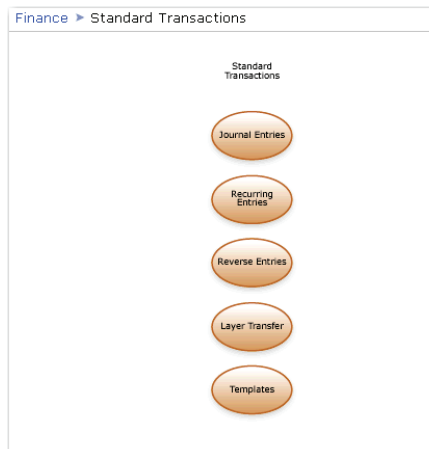

If Level 2 of the map hierarchy opens a detailed process map, the title is represented in a collection node.

Fig. 1.9
Title in Collection Node

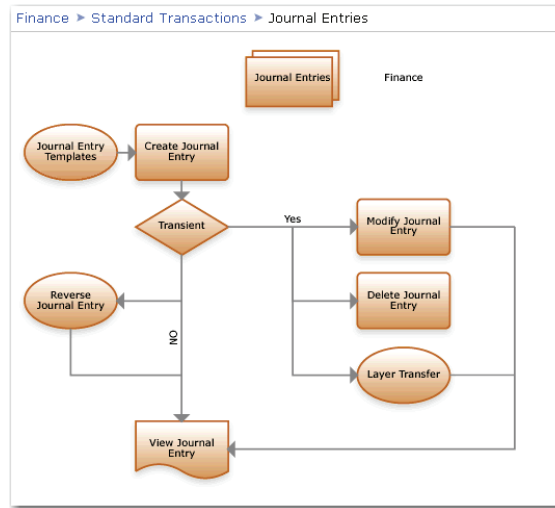

Lowest Level

At the lowest level of a process map where the map does not open any subsequent maps, the title is not placed above the map. Instead, the title is indicated by a breadcrumb trail.

Fig. 1.10
Breadcrumb Trail

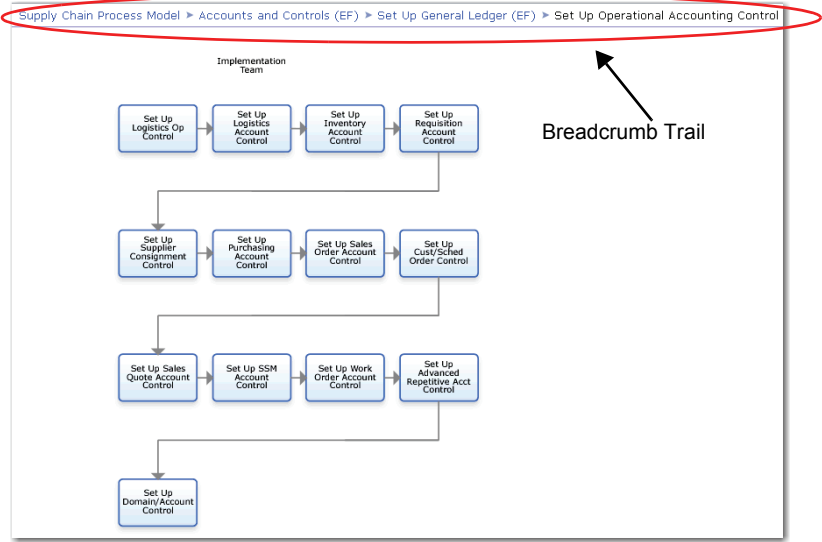

Nodes

When creating process maps for QAD applications, you can use seven types of nodes.

Fig. 1.11
Node Types



- The Menu Item symbols indicates a link to a program on the menu.
- The Other Process Map symbol connects activities on one process map to another process map.
- The Menu Item Collection symbol links to collections.
- The Manual Step symbol indicates tasks performed outside of the QAD application, for example, external planning tasks.
- The Decision symbol directs the flow of a map when it can branch in two directions.
- The Document symbol represents reports or files, such as Word documents or Excel spreadsheets, that are relevant to a task.
- The Manual Input symbol indicates inputs to the process from external systems or outputs from the process to external systems, for example, Electronic Document Interchange (EDI).

In QAD applications, nodes also indicate a user's permissions with regard to functionality. If the user does not have access to a linked program, the node grays out.

Linking Nodes to Maps and UI Objects

Use the Link field in the Process Editor to specify what the current node will open, for example, another map, a URL, or a window in the UI.

To link to another map, use the process property {QAD_PV}, for example, *{QAD_PV}mapname*.

To link to a QAD window, use the process property {QAD_SH}, for example, *{QAD_SH}componentprogramname* for .Net UI component windows, reports, and processes, and *{QAD_SH}progress programname* for Progress windows.

To link to a URL, enter the URL.

The following are usage examples for the Link field in the Process Editor:

- {QAD_PV}SetupEF_2_4
This node will open a process map named SetupEF_2_4.
- {QAD_SH}BLanguage.Create
This node will open the Language Create .NET UI component window.
- {QAD_SH}adctrymt.p
This node will open the Country Data Maintenance window.

Fig. 1.12
Link Field

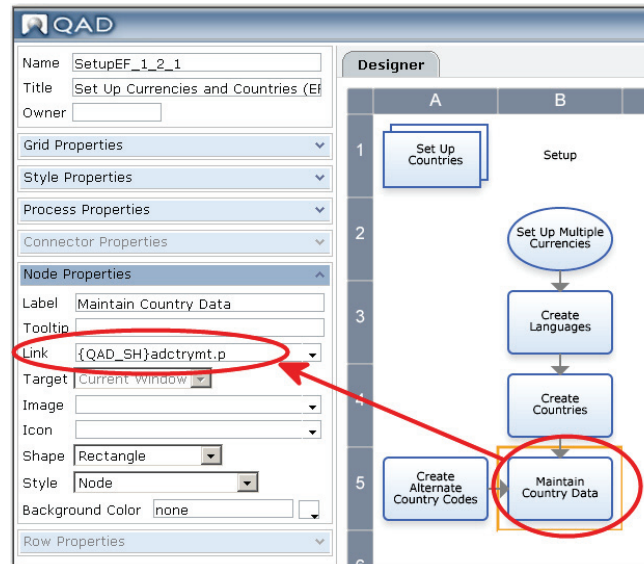

Note You can also use *{QAD_SH}menunumber* to link to and open .NET UI component windows. However, because menu numbers can change from release to release, it is recommended to use the component program name when linking.

The Link field is case sensitive.

Layout

In QAD applications, process map nodes are arranged in a grid. Use the grid to lay out process nodes in a way that is easy to follow.

The following are some guidelines on layout:

- Organize nodes in such a way that the length of the connectors is minimized.
- Move the nodes as close to each other as possible.
- Make the space between boxes as uniform as possible. It is better to have a simpler layout with fewer tasks than a more complicated one showing all steps.

The default grid size is 6 x 6. You may not need to use all the rows or columns, but the finished map must appear within a 6 x 6 grid. Reducing the size of the grid may increase the size of the nodes and create consistency problems when the process maps are printed.

The maximum grid size is 7 columns x 9 rows. Exceeding this limit will cause the size of each node to decrease and become too small to read when incorporated in printed documentation

If the size of a map exceeds the 7 x 9 row limit:

- Remove extraneous rows or columns.
- Simplify the map by removing tasks.
- Move some tasks to a separate process.

Arrows and Connectors

Figure 1.13 shows the arrow and connector types available in the Process Editor.

Fig. 1.13
Arrows and Connectors

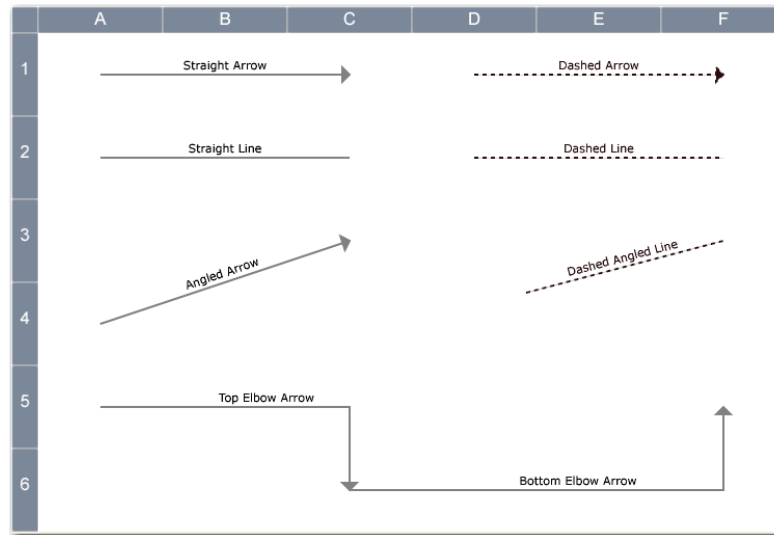

Arrows

Flow arrows indicate the order in which activities are performed, and depict the process flow. The usual direction of the flow of a procedure or system is from left to right or top to bottom.

If your design includes two or more arrows leading from a single process node, this can be represented using a decision node.

Connectors

It is recommended not to cross connectors because they make the process map less readable. Split the process map into two pages, if necessary. Interchange the direction of Y and N on decision boxes to avoid crossing connectors or to reduce the length of the connectors.

In QAD process maps, dotted lines are used to denote optional steps.

Creating or Modifying Process Maps

The following are guides for creating or modifying process maps:

- 1** Decide the boundaries of the process, such as what step initiates and ends the process.
- 2** Name the process. A good process name clearly indicates the result or end state of the process.
- 3** Create a paper design of the process map.
In the earliest design stages, it can help to write steps down on cards or paper to allow easy rearrangement.
- 4** Prototype the map by sequencing the steps and decision points.
Consider the next task in the process, whether a decision point is required, and whether the map reflects the actual process.
- 5** Review the prototype with colleagues who are familiar with the process. Rectify any issues discovered during review.
- 6** Review the process map design with colleagues unfamiliar with the process to determine if the map flow is clear. Rectify any issues discovered during review.

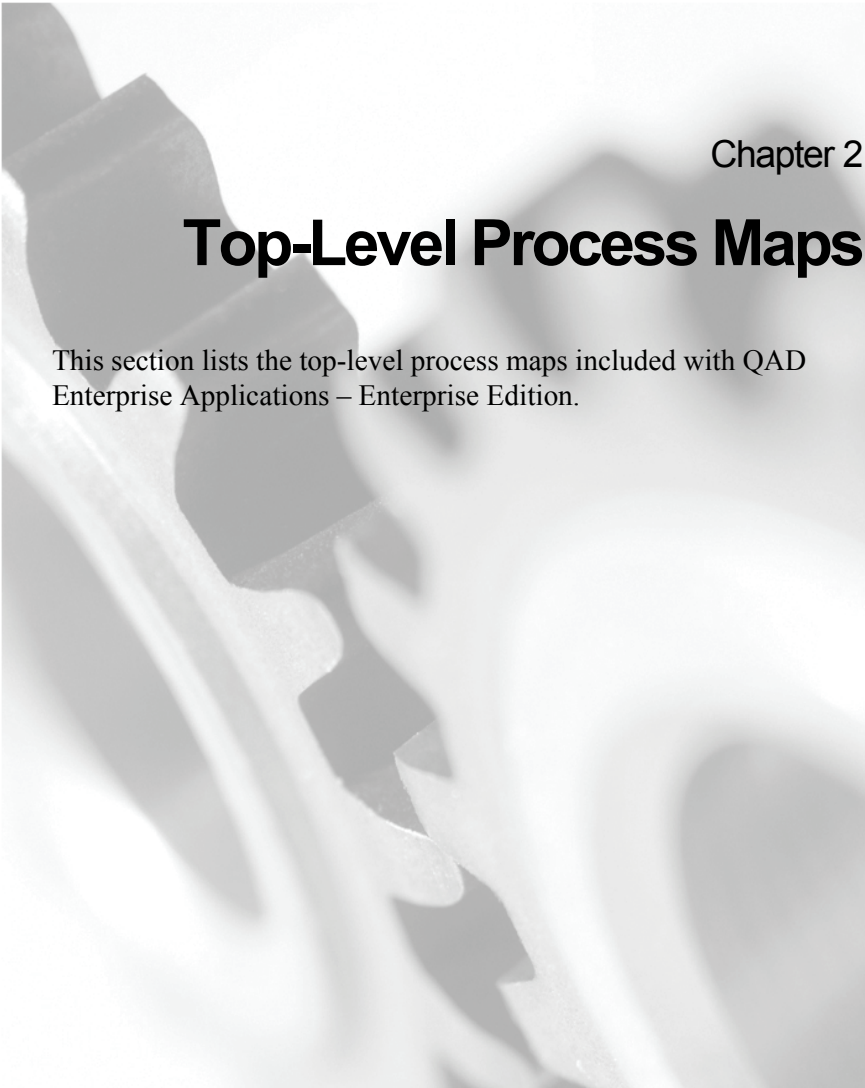

Chapter 2

Top-Level Process Maps

This section lists the top-level process maps included with QAD Enterprise Applications – Enterprise Edition.

Supply Chain Process Model



Vertical Industry Process Model

Collaborate Using QAD SV

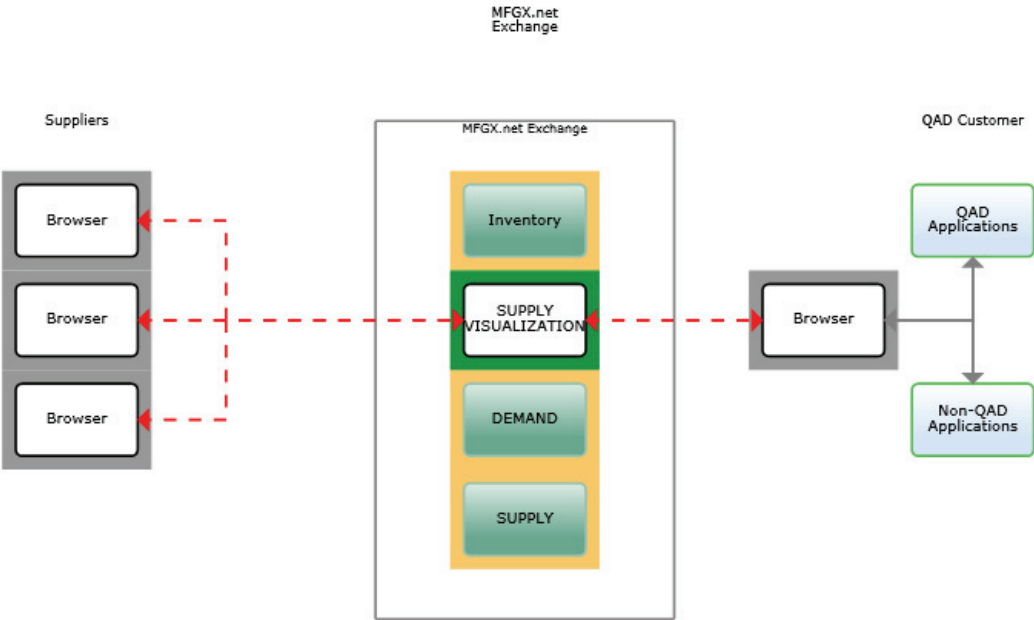

[QAD_SV.xml]

Vertical Industry Process Model

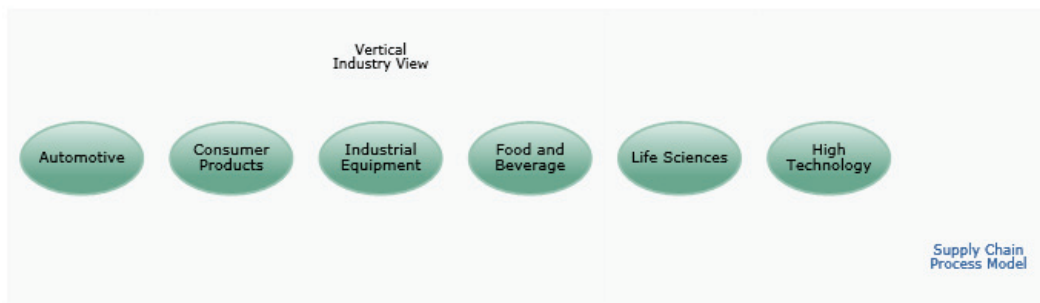

[1_VIP_EF.xml]



Chapter 3

Set Up to Run Process Maps

This chapter lists the Set Up to Run Life Sciences process maps included with QAD Enterprise Applications – Enterprise Edition.

Life Sciences Top Level

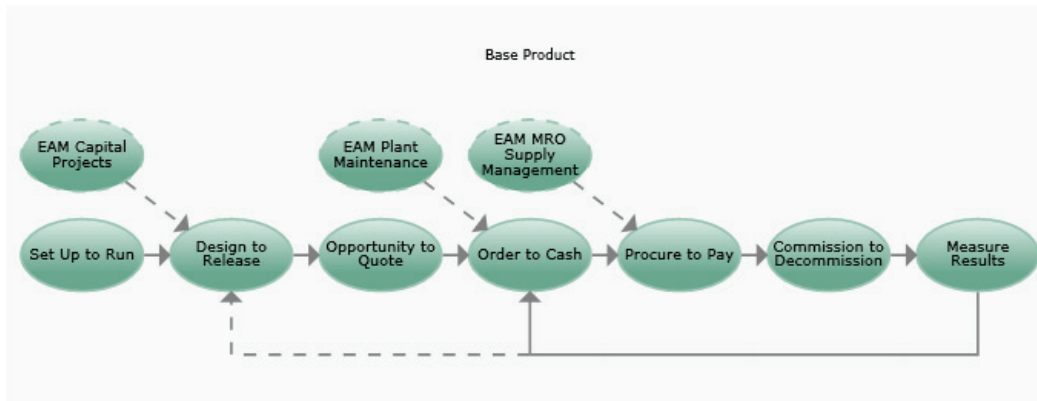

	A	B	C	D	E	F
1						
2						
3						
4						
5						
6						



Set Up to Run Top Level

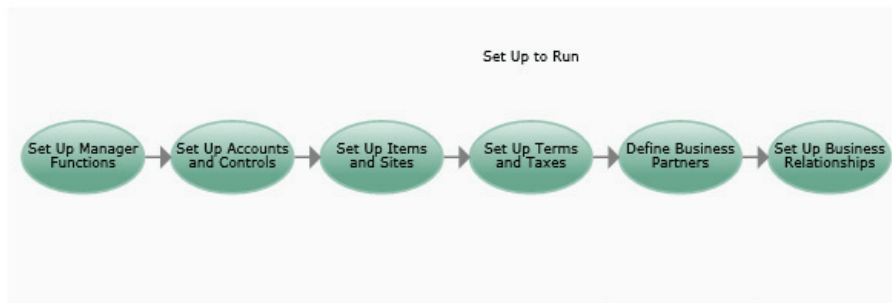

	A	B	C	D	E	F
1						
2						
3						
4						
5						
6						



Set Up Manager Functions (EF)

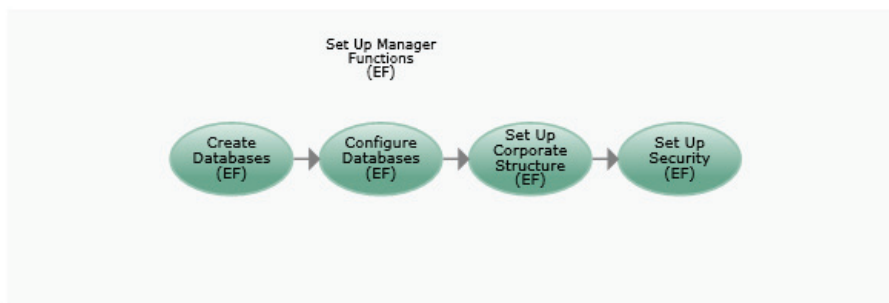

	A	B	C	D	E	F
1						
2						
3						
4						
5						
6						



Create Databases (EF)

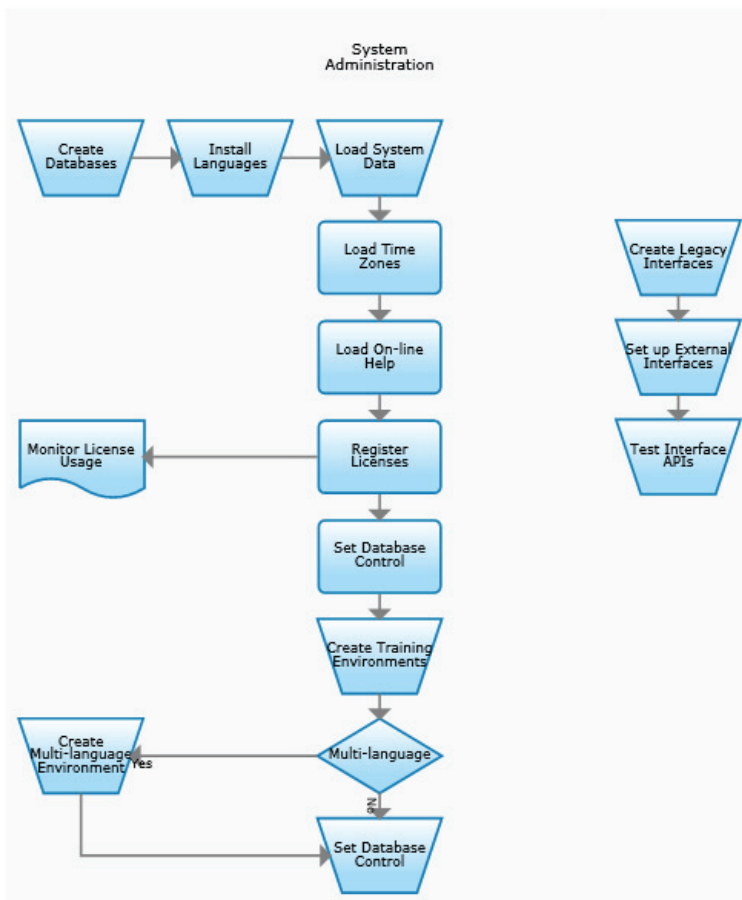

[SetupEF_1_1.xml]

	A	B	C	D	E	F
1						
2						
3						
4						
5						
6						



Configure Databases (EF)

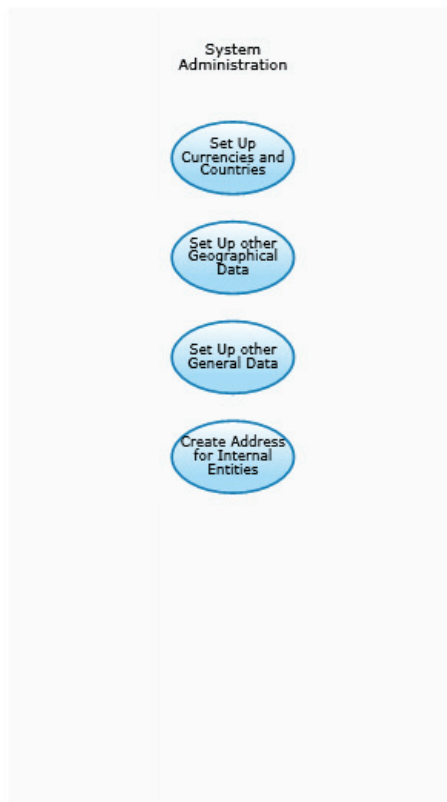

[SetupEF_1_2.xml]

	A	B	C	D	E	F
1						
2						
3						
4						
5						
6						



Set Up Currencies and Countries (EF)

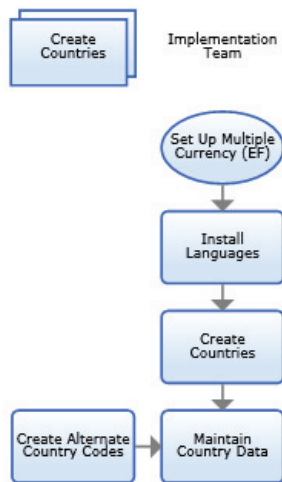

[SetupEF_1_2_1.xml]

	A	B	C	D	E	F
1						
2						
3						
4						
5						
6						



Set Up Other Geographical Data (EF)

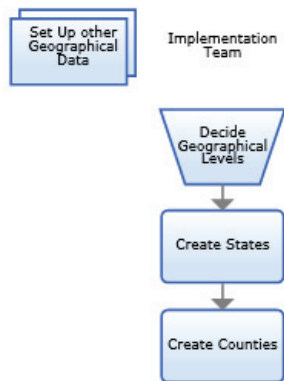

[SetupEF_1_2_2.xml]

	A	B	C	D	E	F
1						
2						
3						
4						
5						
6						



Set Up Other General Data (EF)

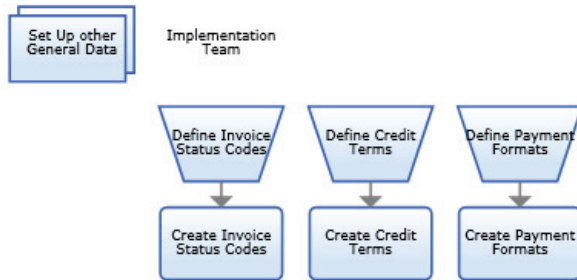

[SetupEF_1_2_3.xml]

	A	B	C	D	E	F
1						
2						
3						
4						
5						
6						



Create Address for Internal Entities (EF)

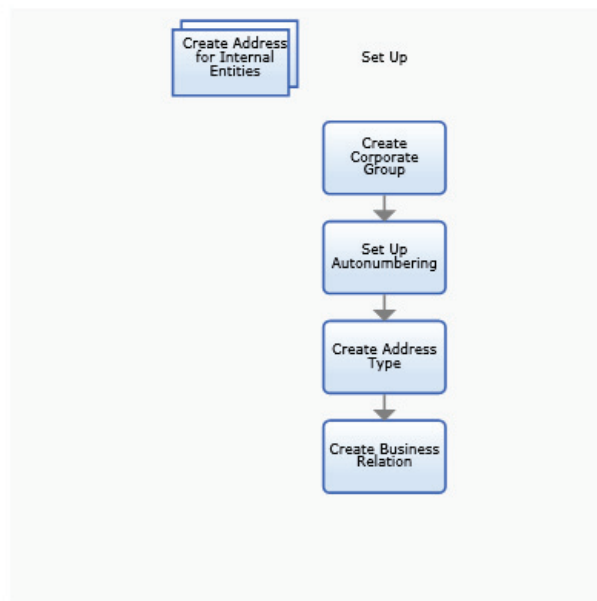

[SetupEF_1_2_5.xml]

	A	B	C	D	E	F
1						
2						
3						
4						
5						
6						



Set Up Corporate Structure (EF)

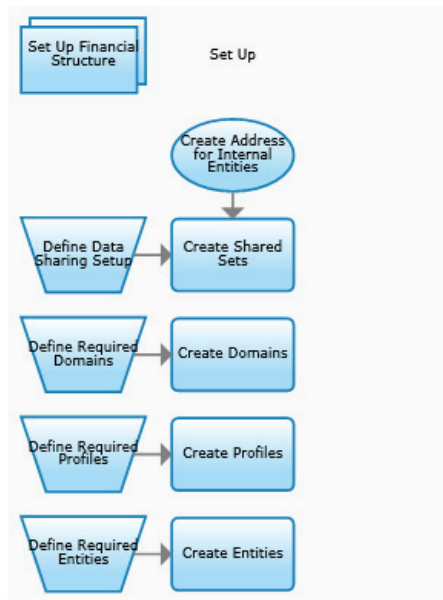

[SetupEF_1_3.xml]

	A	B	C	D	E	F
1						
2						
3						
4						
5						
6						



Set Up Security (EF)

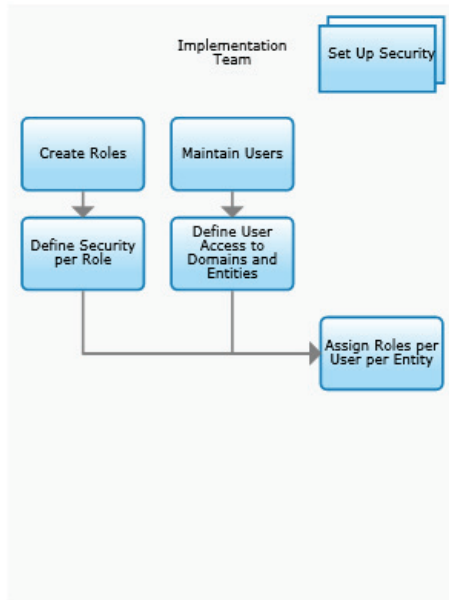

[SetupEF_1_4.xml]

	A	B	C	D	E	F
1						
2						
3						
4						
5						
6						



Set Up Accounts and Controls (EF)

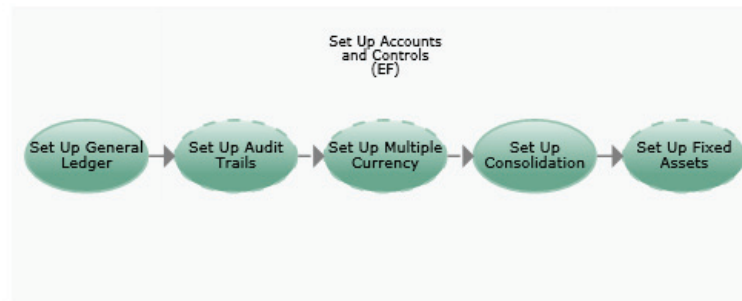

	A	B	C	D	E	F
1						
2						
3						
4						
5						
6						



Set Up General Ledger (EF)

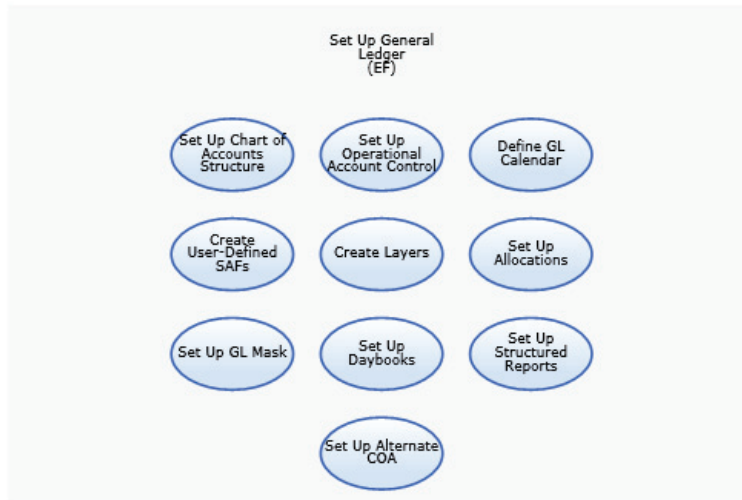

[SetupEF_2_1.xml]

	A	B	C	D	E	F
1						
2						
3						
4						
5						
6						



Set Up Daybooks (EF)

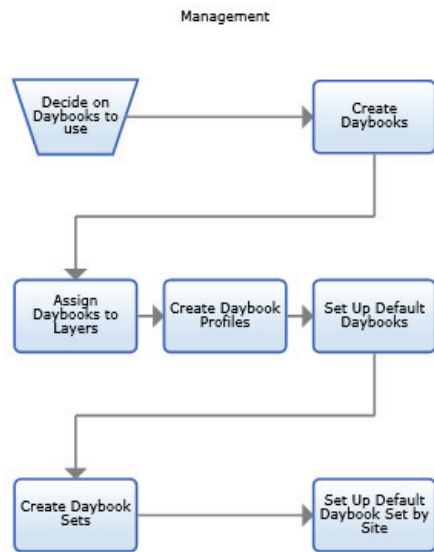

[SetupEF_2_1_1.xml]

	A	B	C	D	E	F
1						
2						
3						
4						
5						
6						



Set Up Charts of Account Structure

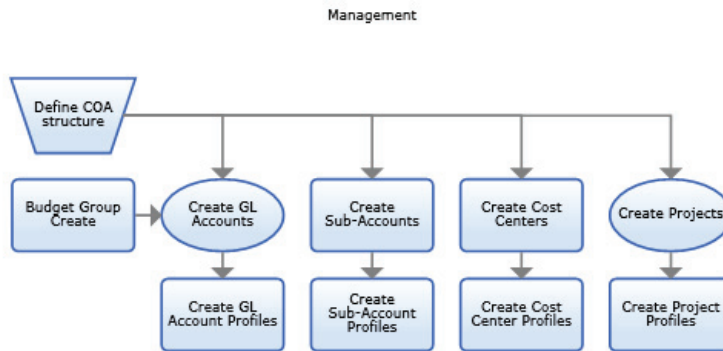

[SetupEF_2_1_2.xml]

	A	B	C	D	E	F
1						
2						
3						
4						
5						
6						



Set Up SAFS

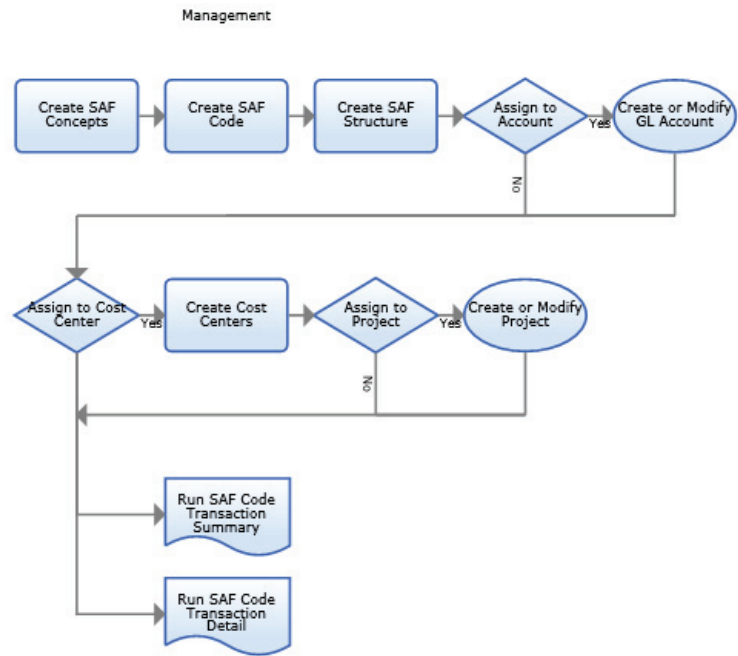

[SetupEF_2_1_2_5.xml]

	A	B	C	D	E	F
1						
2						
3						
4						
5						
6						



Set Up GL Mask

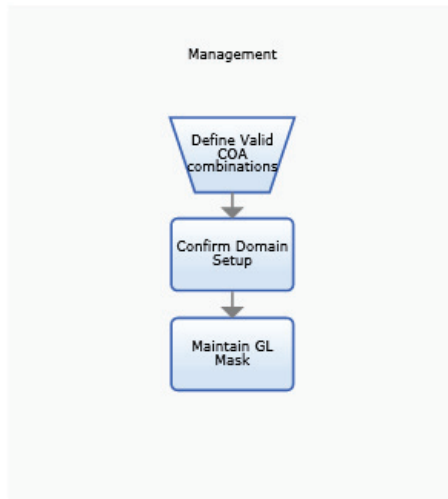

[SetupEF_2_1_3.xml]

	A	B	C	D	E	F
1						
2						
3						
4						
5						
6						



Set Up Structured Reports

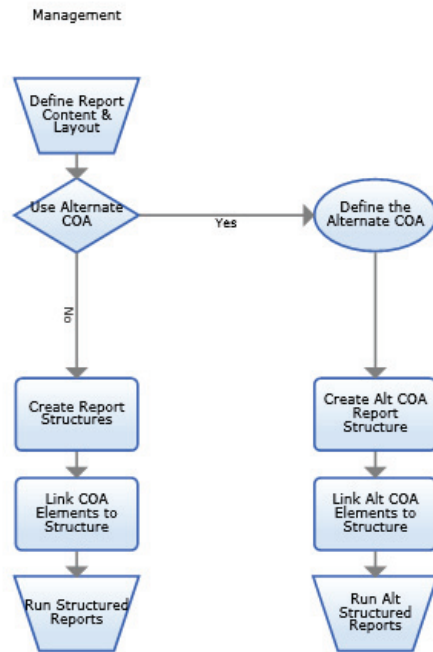

[SetupEF_2_1_4.xml]

	A	B	C	D	E	F
1						
2						
3						
4						
5						
6						



Define GL Calendar

Management

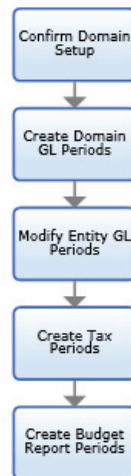

[SetupEF_2_1_5.xml]

	A	B	C	D	E	F
1						
2						
3						
4						
5						
6						



Set Up Layers

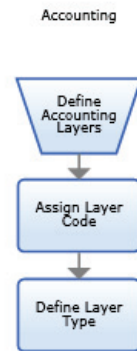

[SetupEF_2_1_7.xml]

	A	B	C	D	E	F
1						
2						
3						
4						
5						
6						



Set Up Operational Accounting Controls

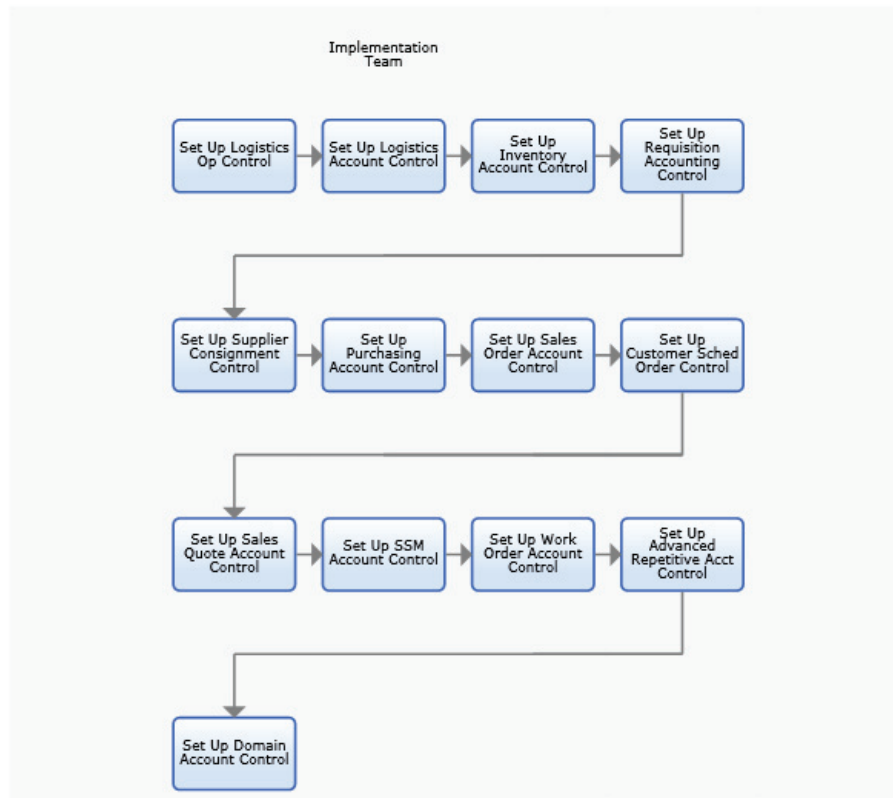

[SetupEF_2_1_8.xml]

	A	B	C	D	E	F
1						
2						
3						
4						
5						
6						



Set Up Allocations (EF)

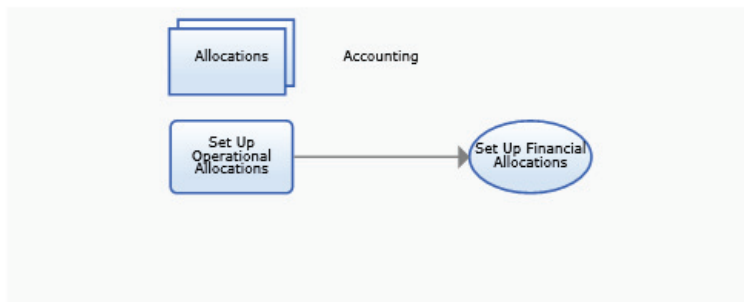

[SetupEF_2_5.xml]

	A	B	C	D	E	F
1						
2						
3						
4						
5						
6						



Set Up Financial Allocations

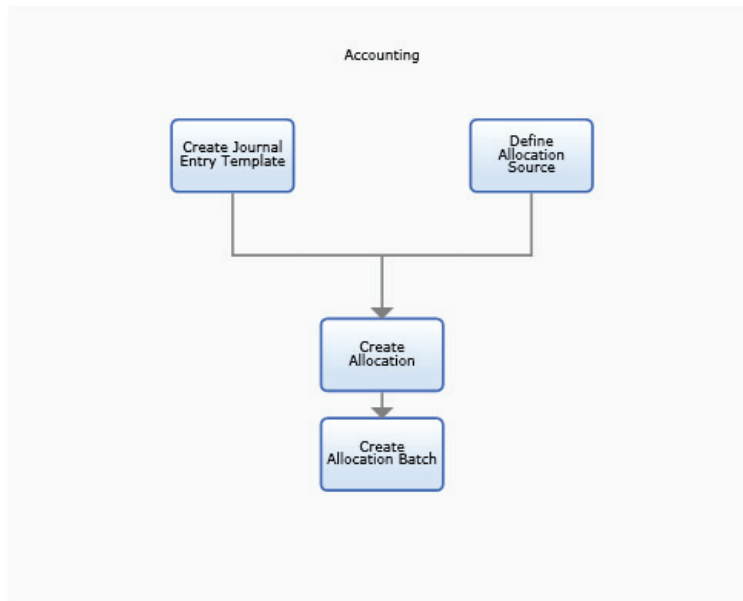

[SetupEF_2_5_1.xml]

	A	B	C	D	E	F
1						
2						
3						
4						
5						
6						



Set Up Audit Trails

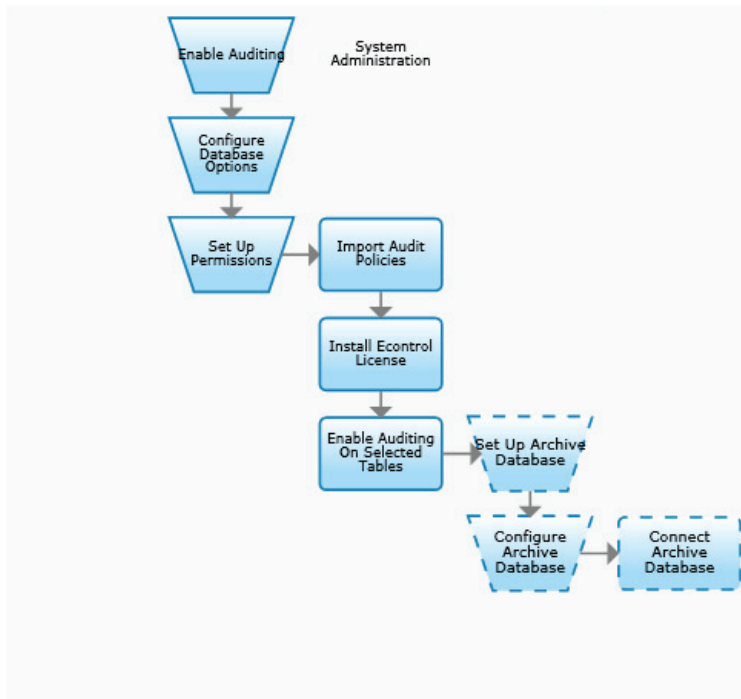

[SetupEF_1_5.xml]

	A	B	C	D	E	F
1						
2						
3						
4						
5						
6						



Set Up Multiple Currency

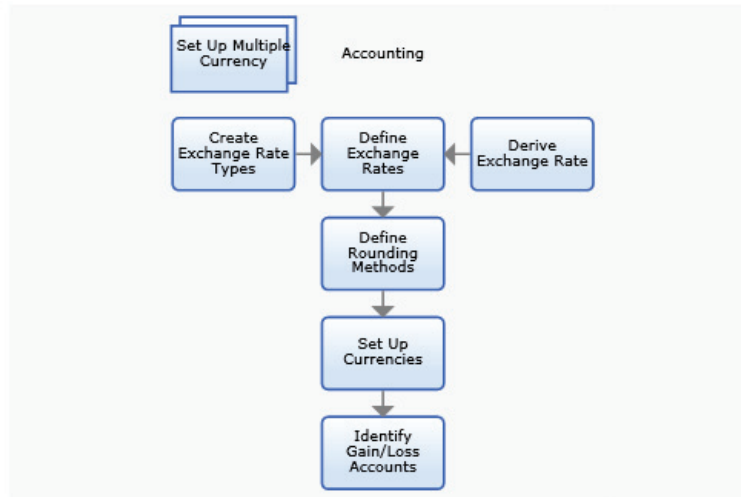

[SetupEF_2_4.xml]

	A	B	C	D	E	F
1						
2						
3						
4						
5						
6						



Set Up Consolidation

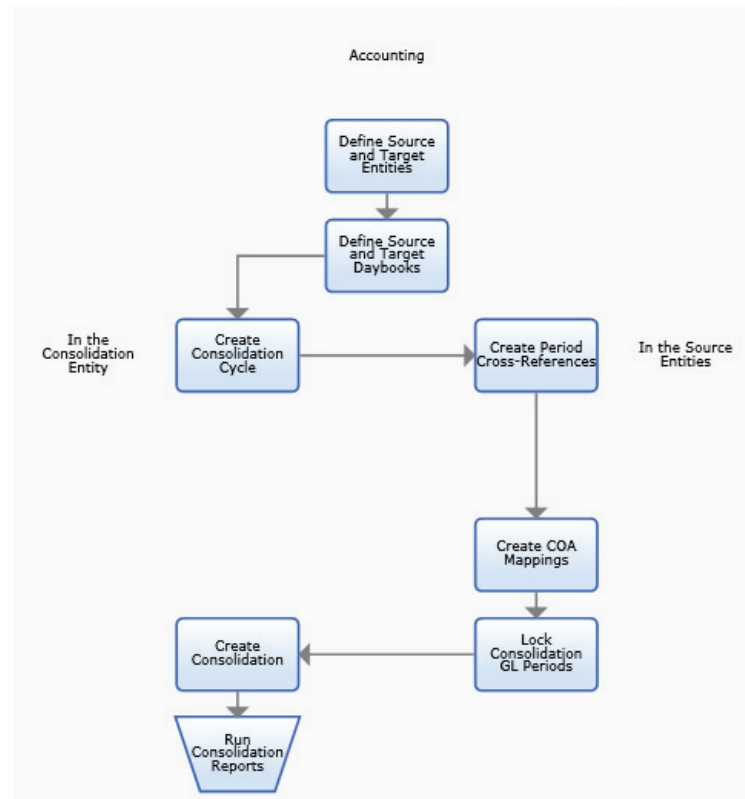

[SetupEF_2_6.xml]

	A	B	C	D	E	F
1						
2						
3						
4						
5						
6						



Set Up Fixed Assets

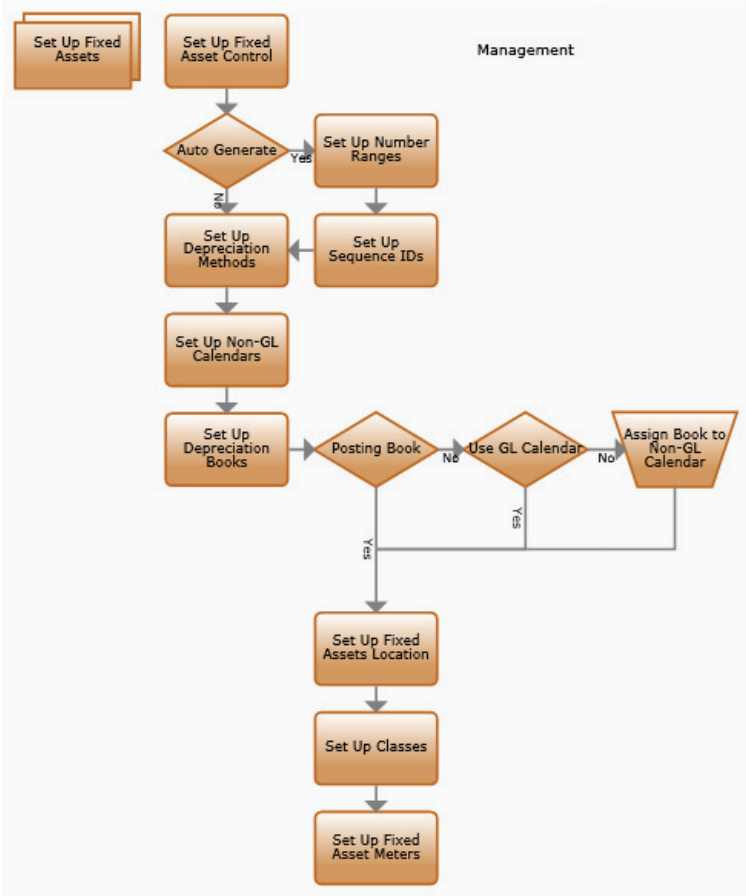

[Finance_7_1.xml]

	A	B	C	D	E	F
1						
2						
3						
4						
5						
6						



Set Up Items and Sites



	A	B	C	D	E	F
1						
2						
3						
4						
5						
6						



Set Up Sites

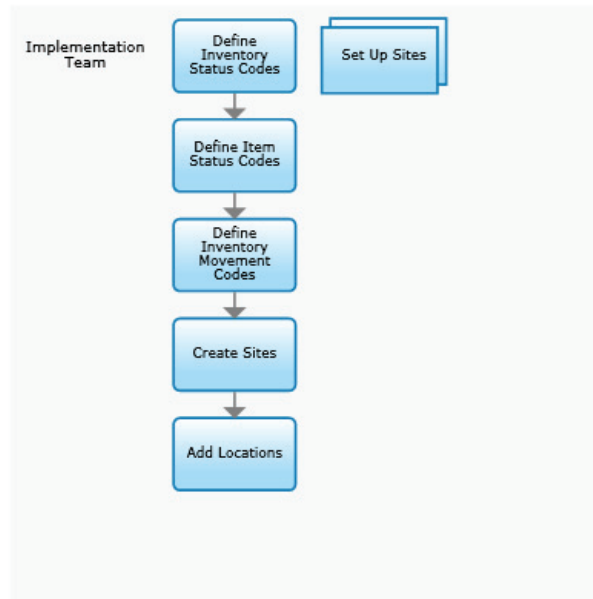

[Setup_3_1.xml]

	A	B	C	D	E	F
1						
2						
3						
4						
5						
6						



Set Up Site Security

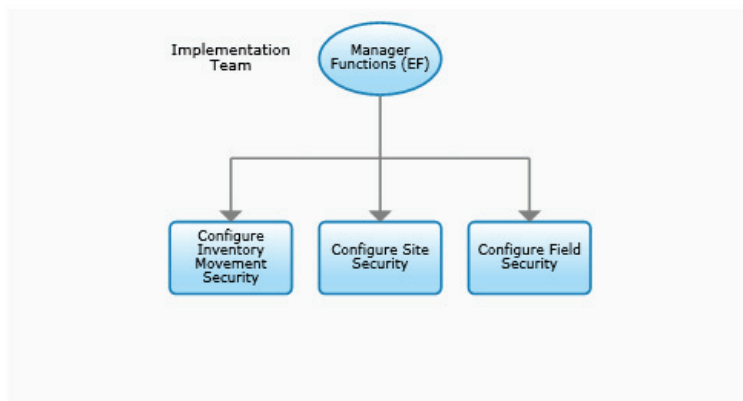

[Setup_3_2.xml]

	A	B	C	D	E	F
1						
2						
3						
4						
5						
6						



Layout Warehouse

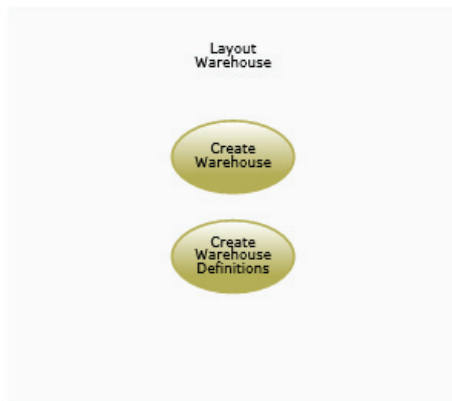

[Warehouse_6_1.xml]

	A	B	C	D	E	F
1						
2						
3						
4						
5						
6						



Create Warehouse

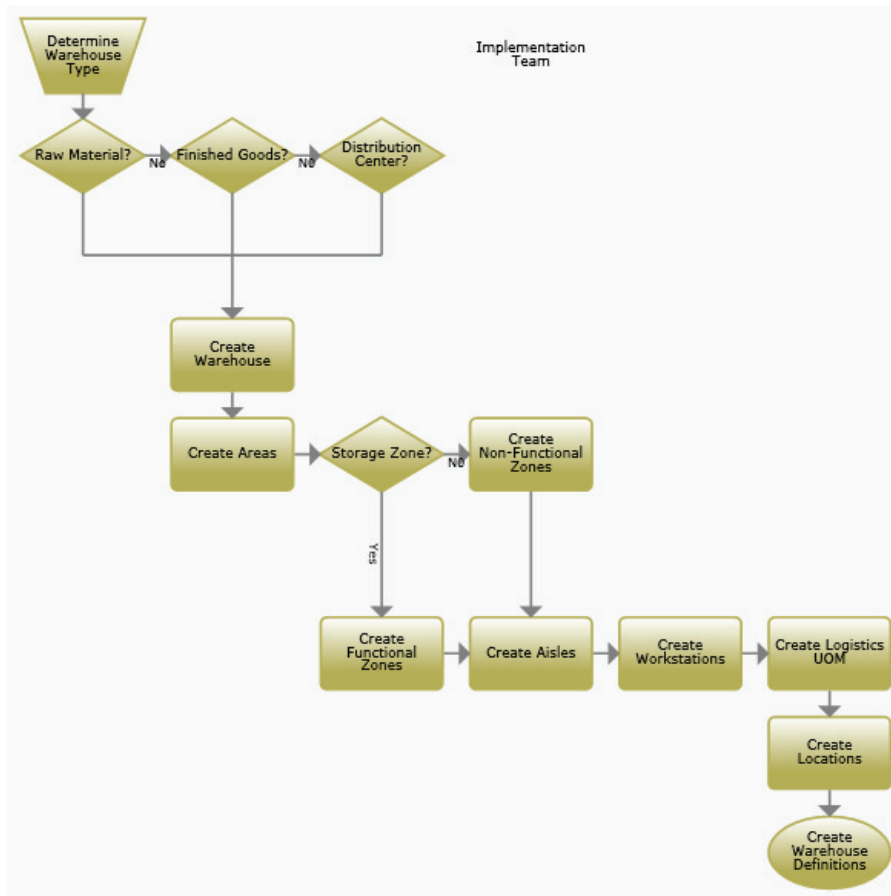

[Warehouse_6_1_1.xml]

	A	B	C	D	E	F
1						
2						
3						
4						
5						
6						



Create Warehouse Definitions

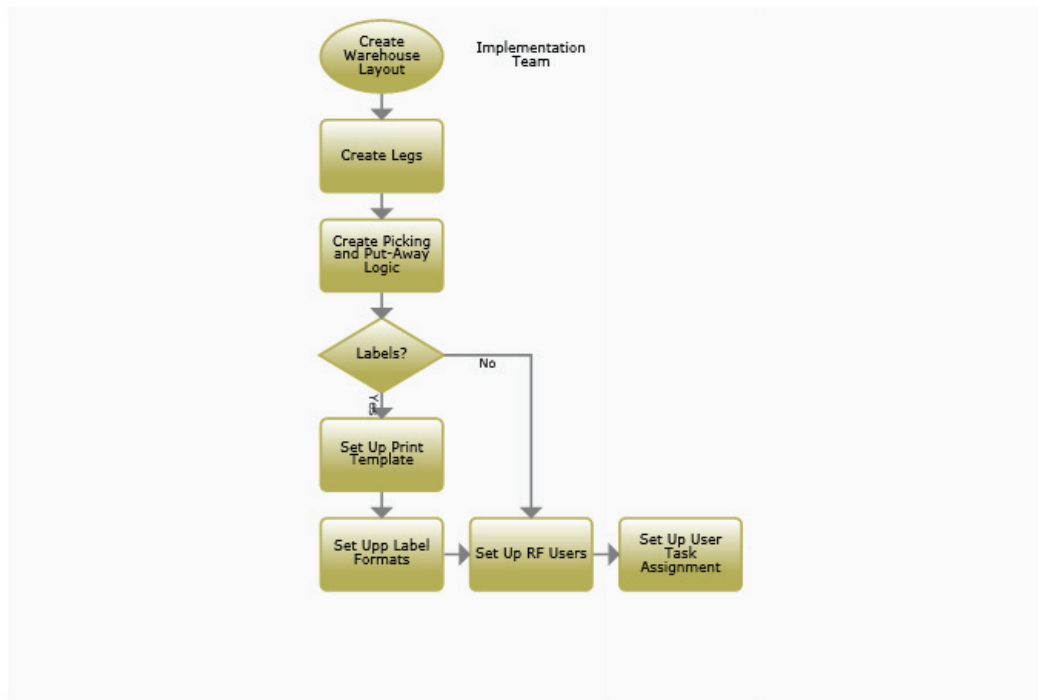

[Warehouse_6_1_2.xml]

	A	B	C	D	E	F
1						
2						
3						
4						
5						
6						



Define Items

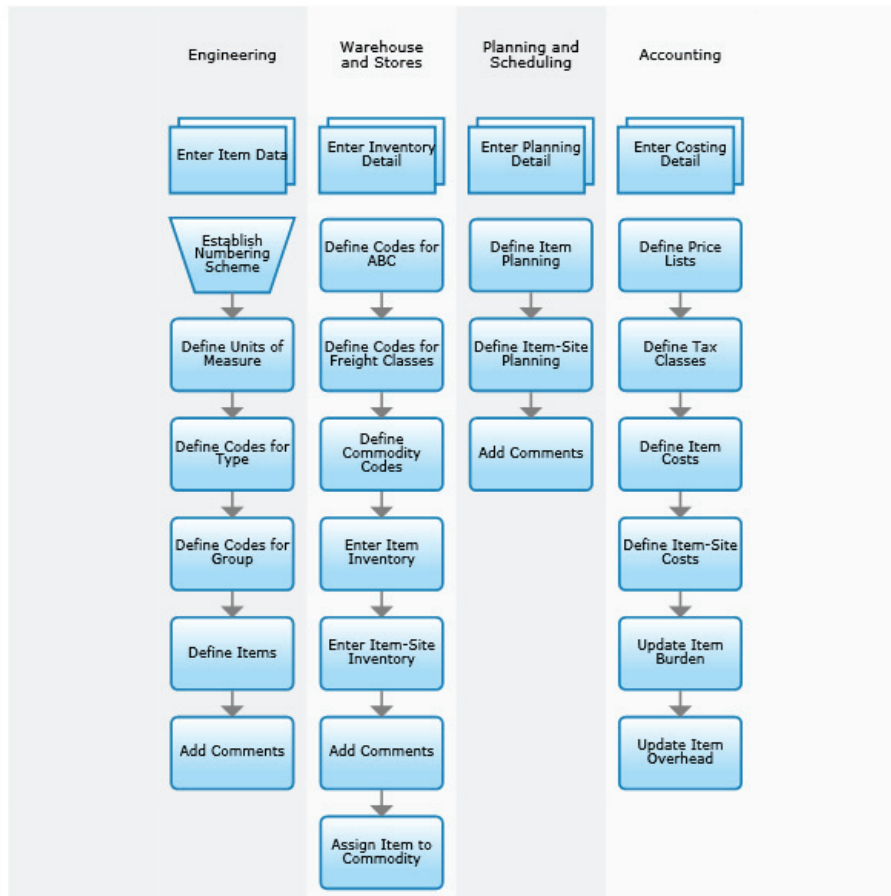

[Setup_3_3.xml]

	A	B	C	D	E	F
1						
2						
3						
4						
5						
6						



Set Up Terms and Taxes

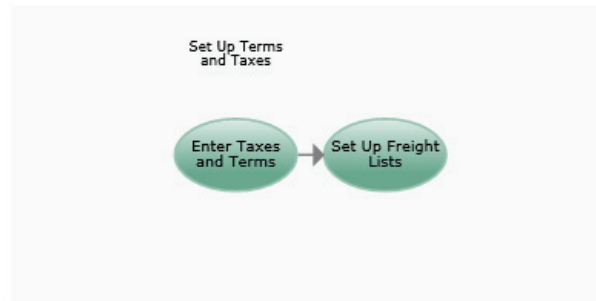

	A	B	C	D	E	F
1						
2						
3						
4						
5						
6						



Enter Terms and Taxes

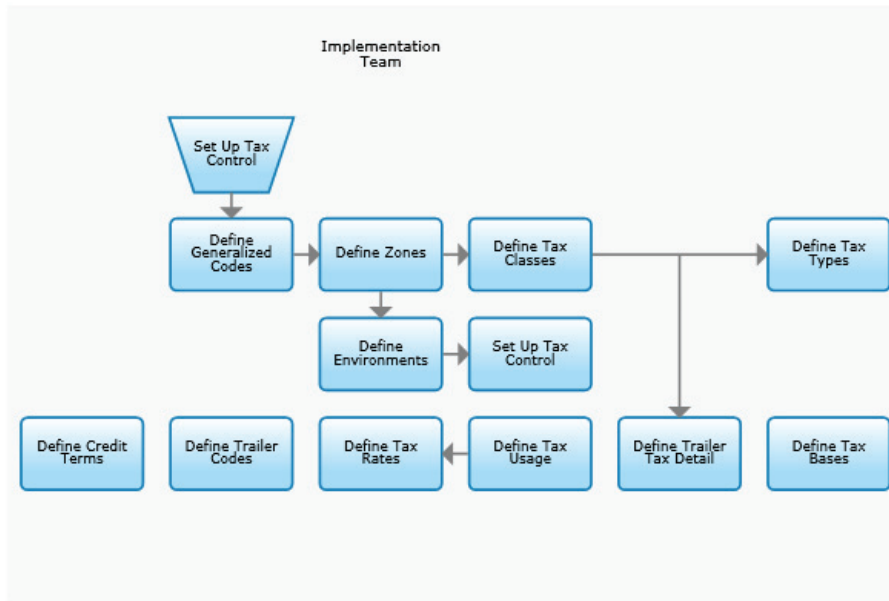

[Setup_4_1.xml]

	A	B	C	D	E	F
1						
2						
3						
4						
5						
6						



Set Up Freight Lists

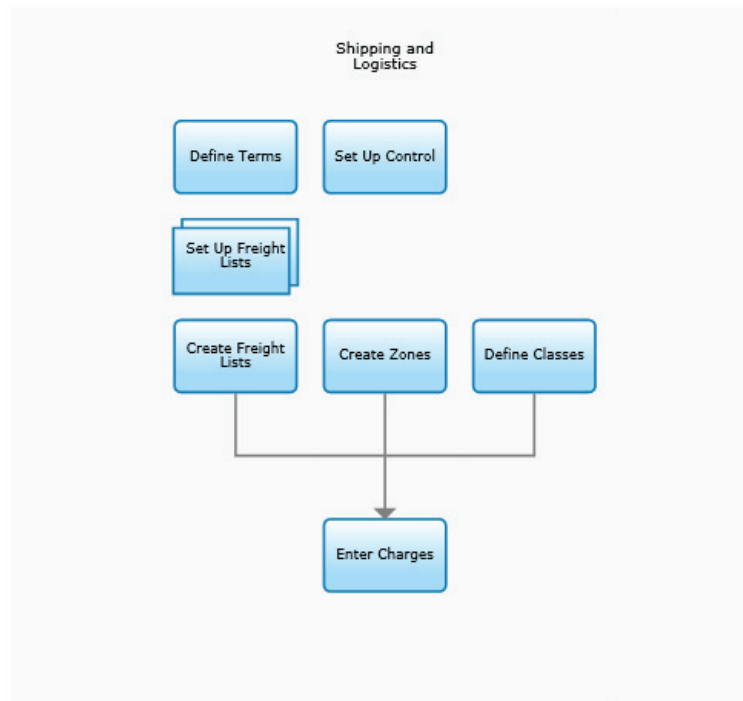

[Setup_4_2.xml]

	A	B	C	D	E	F
1						
2						
3						
4						
5						
6						



Define Business Partners (EF)

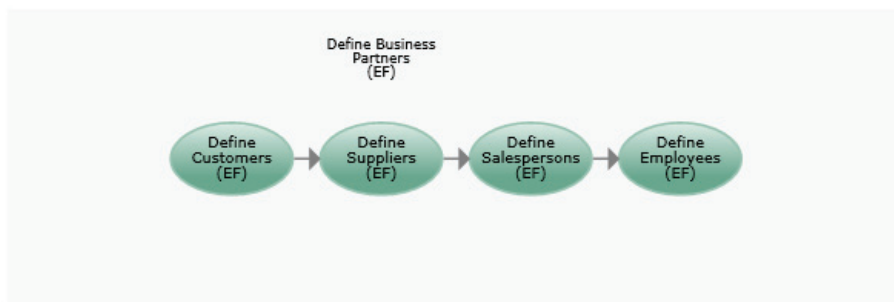

	A	B	C	D	E	F
1						
2						
3						
4						
5						
6						



Define Customers

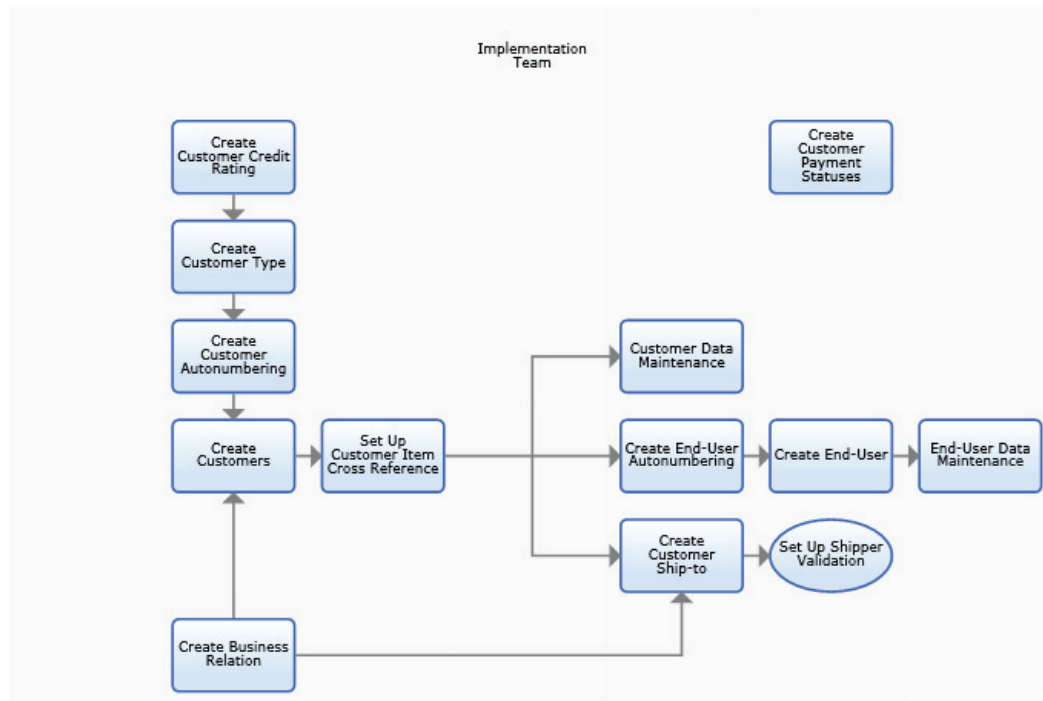

[SetupEF_5_1.xml]

	A	B	C	D	E	F
1						
2						
3						
4						
5						
6						



Define Suppliers (EF)

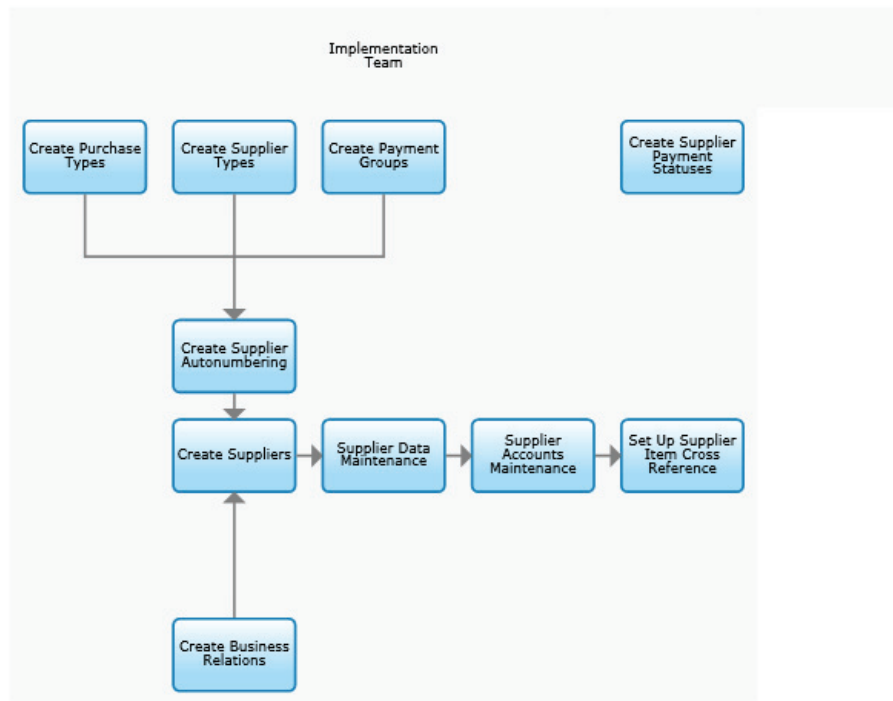

[SetupEF_5_2.xml]

	A	B	C	D	E	F
1						
2						
3						
4						
5						
6						



Define Salespersons (EF)

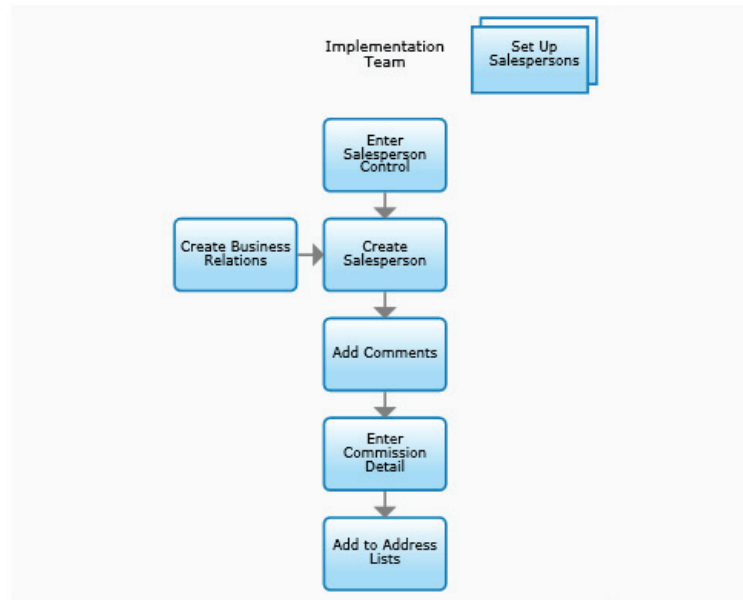

[SetupEF_5_3.xml]

	A	B	C	D	E	F
1						
2						
3						
4						
5						
6						



Define Employees (EF)

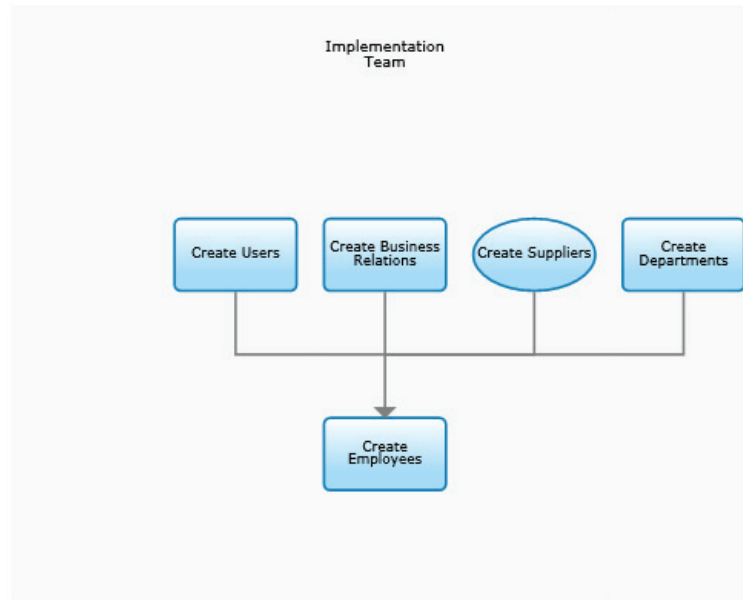

[SetupEF_5_4.xml]

	A	B	C	D	E	F
1						
2						
3						
4						
5						
6						



Set Up Business Relationships

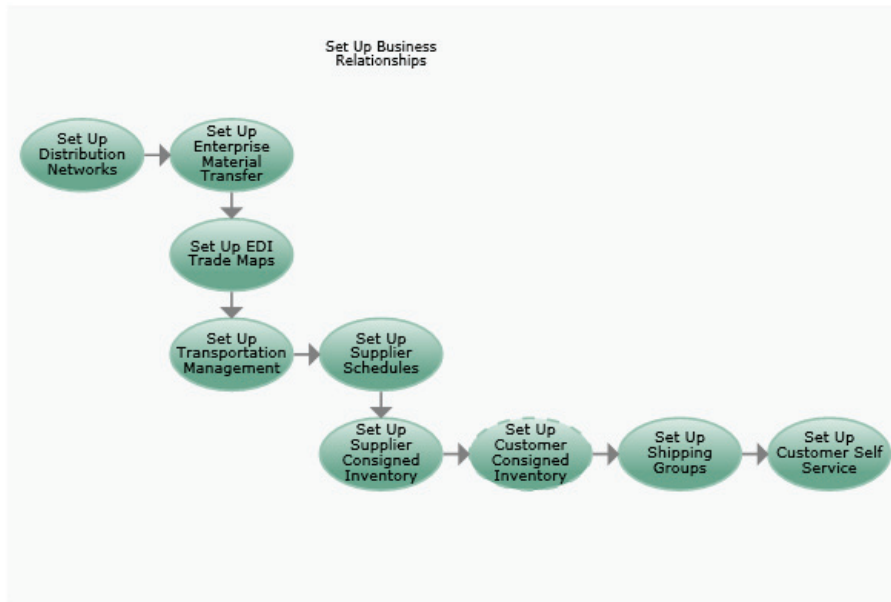

	A	B	C	D	E	F
1						
2						
3						
4						
5						
6						



Set Up Distribution Networks

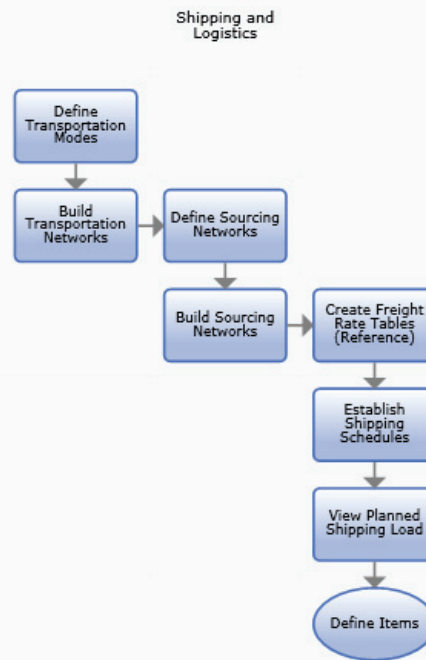

	A	B	C	D	E	F
1						
2						
3						
4						
5						
6						



Set Up Enterprise Material Transfer

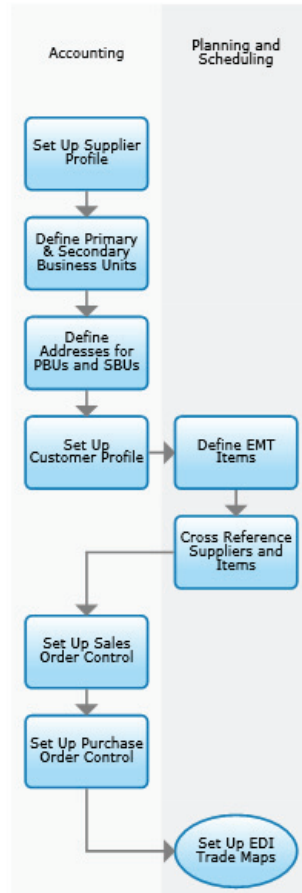

[Setup_6_1.xml]

	A	B	C	D	E	F
1						
2						
3						
4						
5						
6						



Set Up EDI Trade Maps

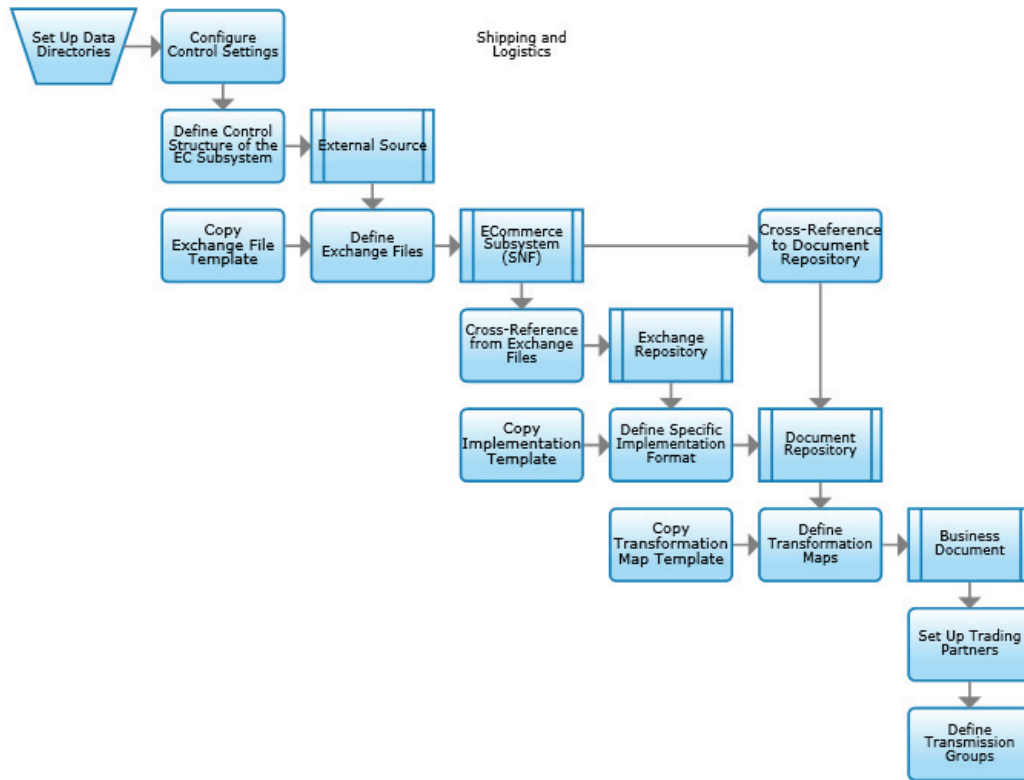

[Setup_6_2.xml]

	A	B	C	D	E	F
1						
2						
3						
4						
5						
6						



Set Up Transportation Management

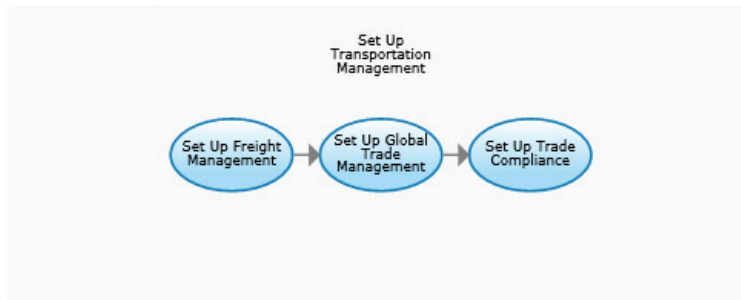

[Setup_6_4.xml]

	A	B	C	D	E	F
1						
2						
3						
4						
5						
6						



Set Up Supplier Schedules

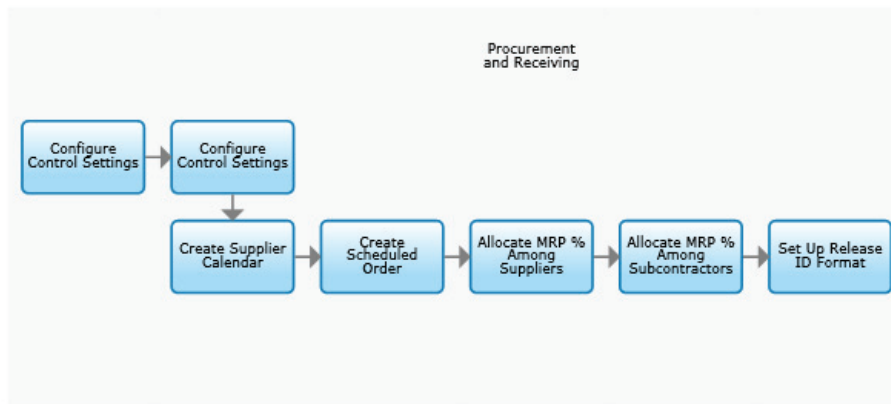

[Setup_6_7_2.xml]

	A	B	C	D	E	F
1						
2						
3						
4						
5						
6						



Set Up Customer Consigned Inventory

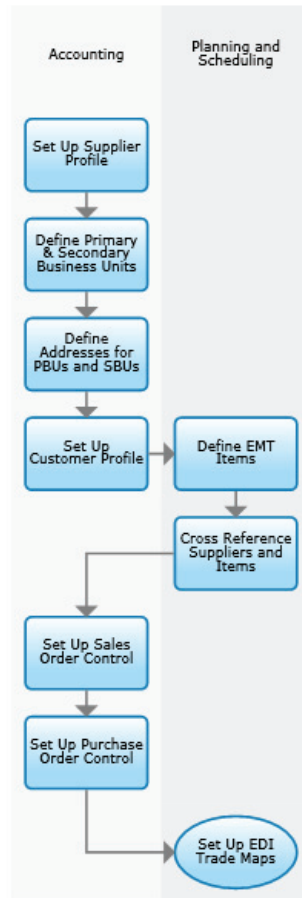

[Deliver_6_1.xml]

	A	B	C	D	E	F
1						
2						
3						
4						
5						
6						



Set Up Supplier Consigned Inventory

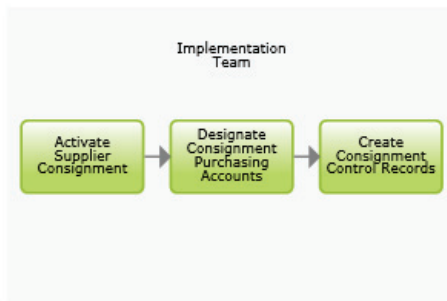

[Warehouse_1_5.xml]

	A	B	C	D	E	F
1						
2						
3						
4						
5						
6						



Set Up Shipping Groups

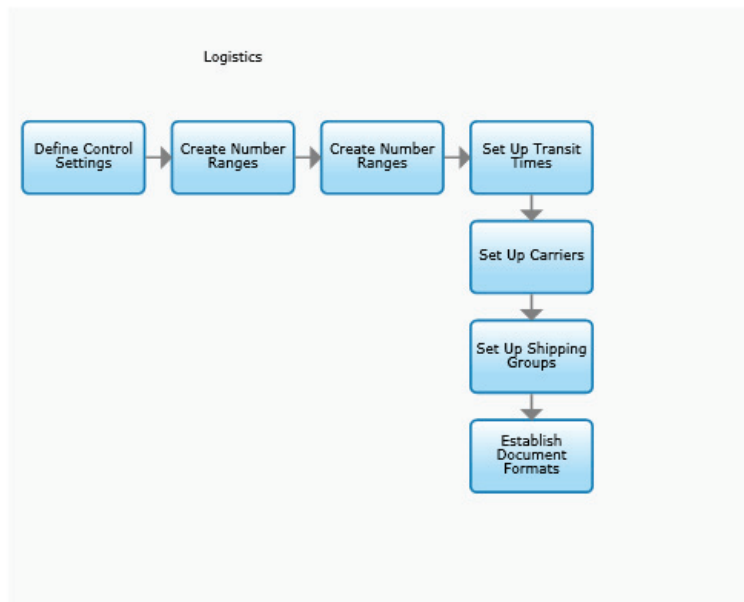

[Setup_6_3.xml]



Chapter 4

Design To Release Process Maps

This chapter lists the Design To Release Life Sciences process maps included with QAD Enterprise Applications – Enterprise Edition.

Life Sciences Top Level

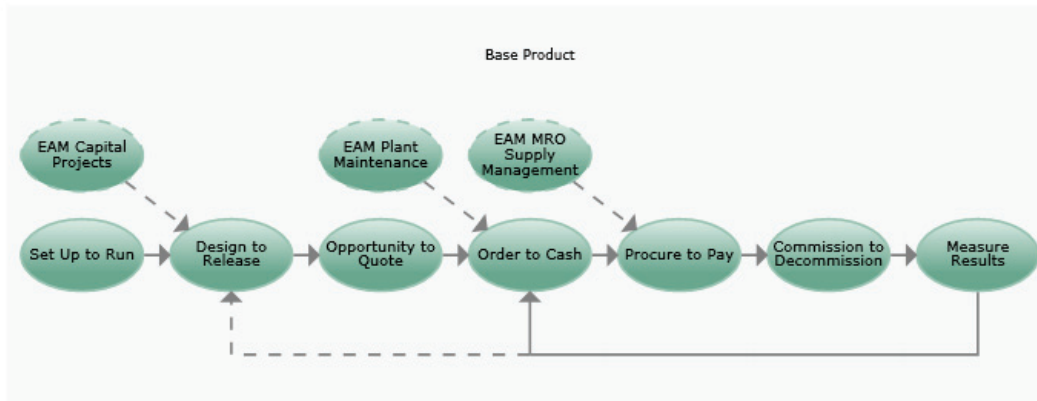

	A	B	C	D	E	F
1						
2						
3						
4						
5						
6						



Design To Release Top Level

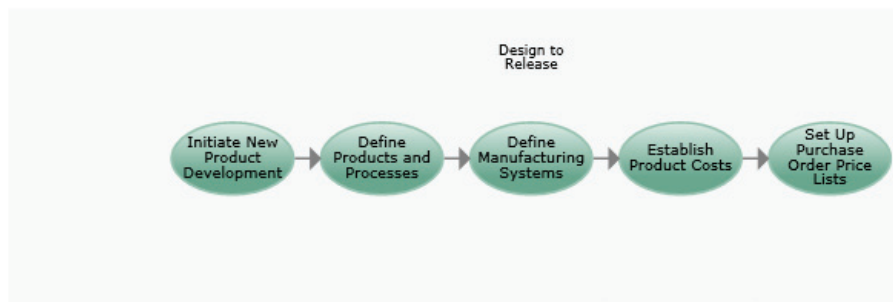

	A	B	C	D	E	F
1						
2						
3						
4						
5						
6						



Initiate New Product Development

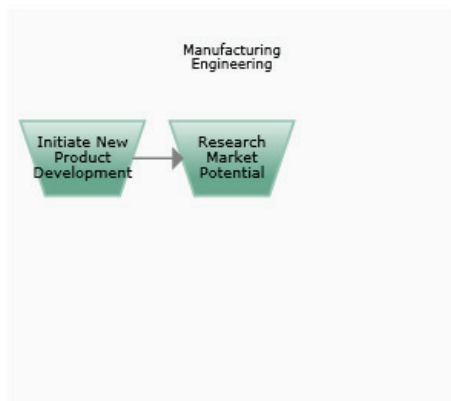

	A	B	C	D	E	F
1						
2						
3						
4						
5						
6						



Define Work Centers

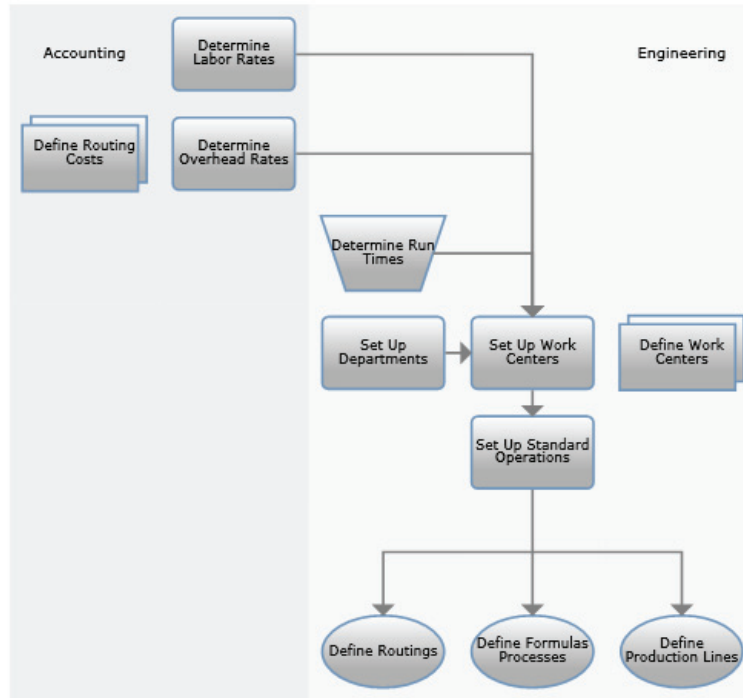

[Make_1_2.xml]

	A	B	C	D	E	F
1						
2						
3						
4						
5						
6						



Define Products and Processes

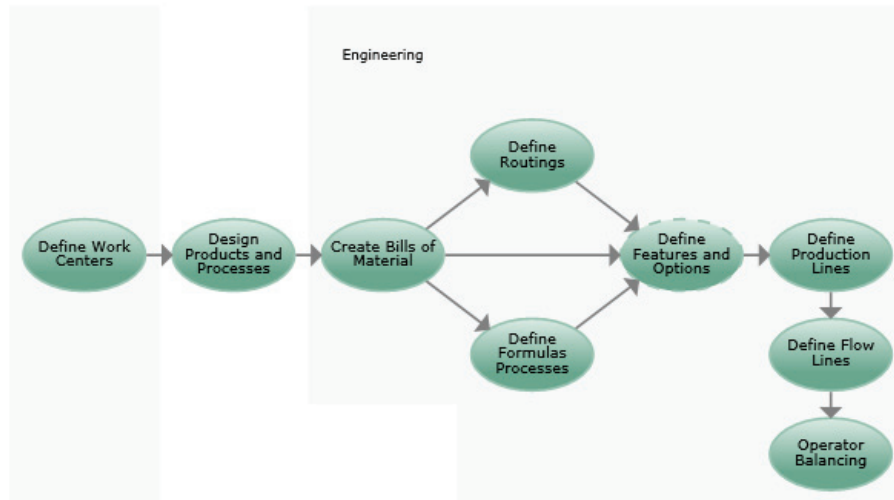

	A	B	C	D	E	F
1						
2						
3						
4						
5						
6						



Create Bills of Material

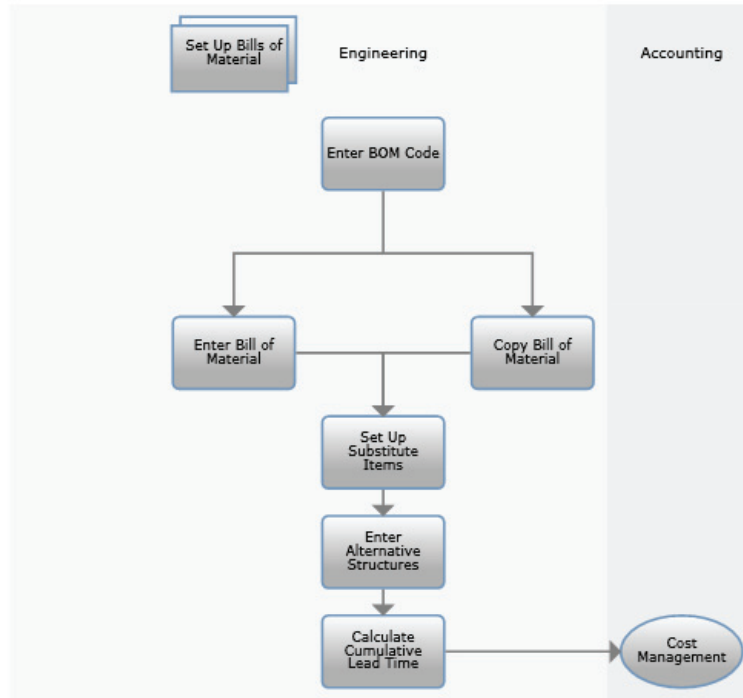

[Make1_1.xml]

	A	B	C	D	E	F
1						
2						
3						
4						
5						
6						



Define Features and Options

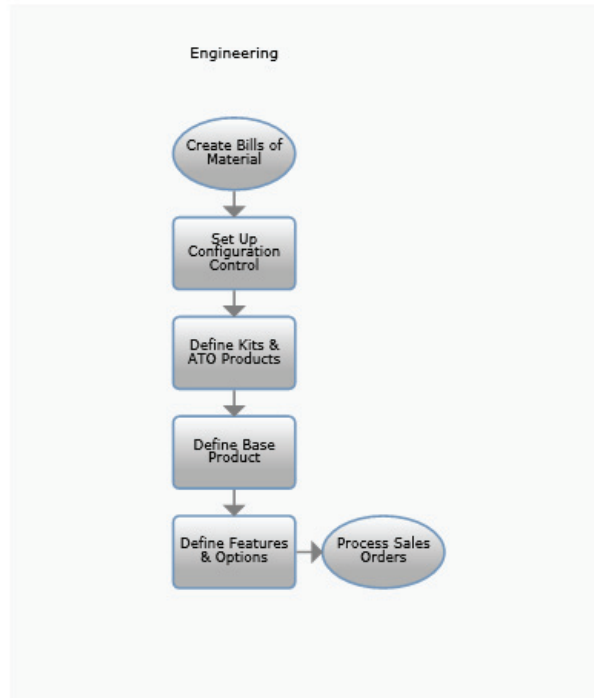

[Make_1_4.xml]

	A	B	C	D	E	F
1						
2						
3						
4						
5						
6						



Set Up QAD Configurator

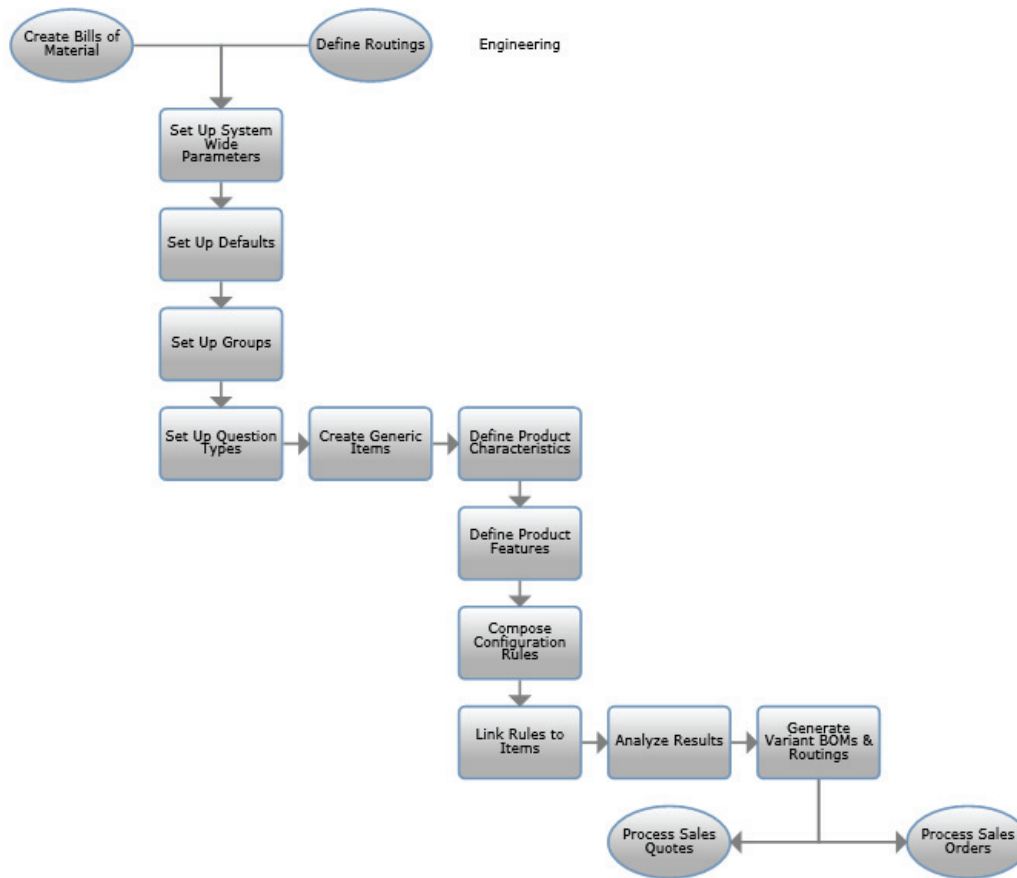

[Make_1_8.xml]

	A	B	C	D	E	F
1						
2						
3						
4						
5						
6						



Define Routings

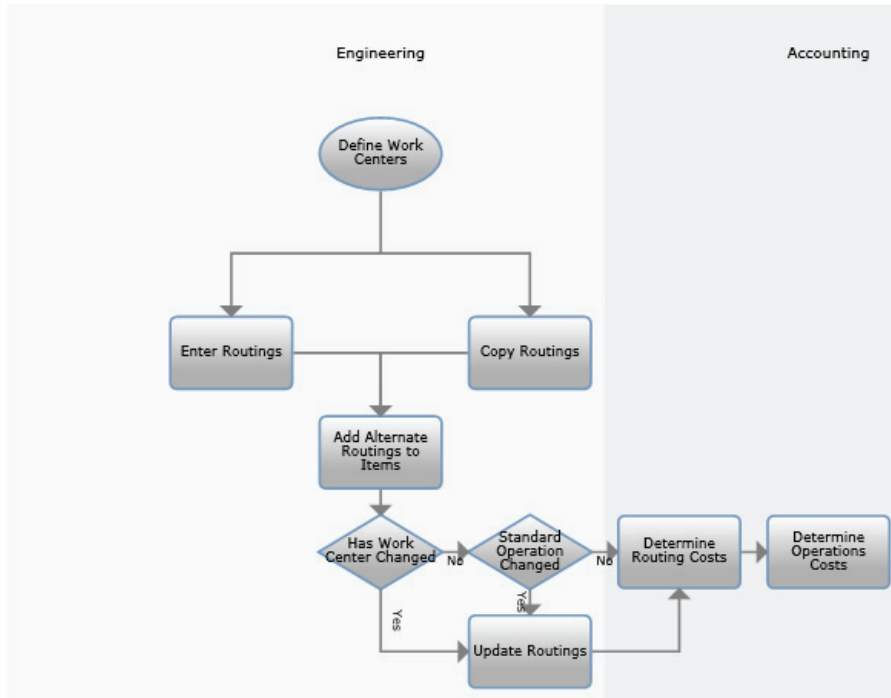

[Make_1_3.xml]

	A	B	C	D	E	F
1						
2						
3						
4						
5						
6						



Define Formulas and Processes

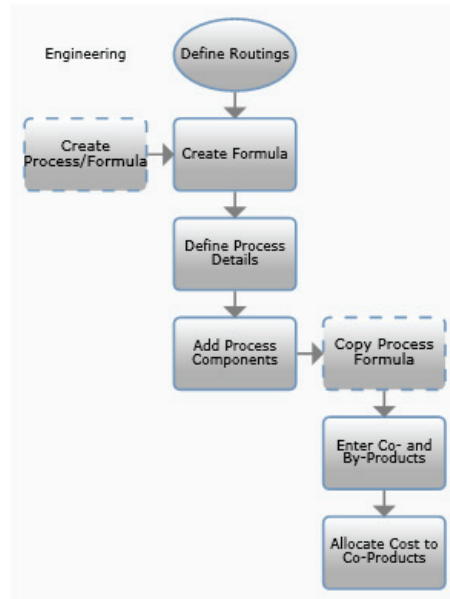

	A	B	C	D	E	F
1						
2						
3						
4						
5						
6						



Define Production Lines

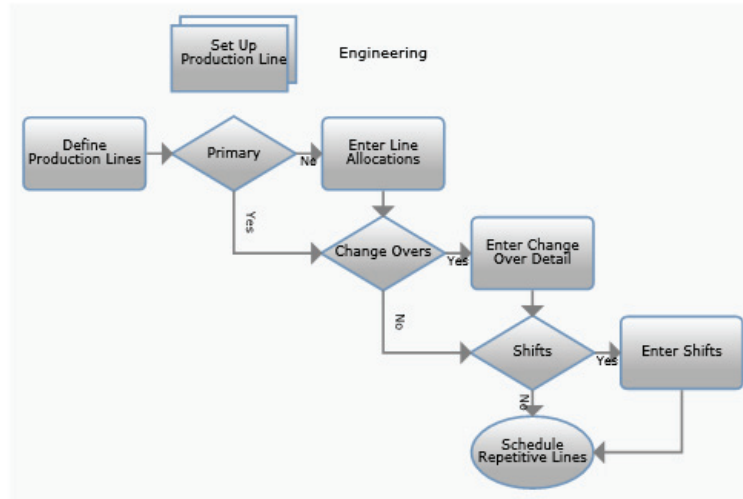

[Make_1_6.xml]

	A	B	C	D	E	F
1						
2						
3						
4						
5						
6						



Operator Balancing

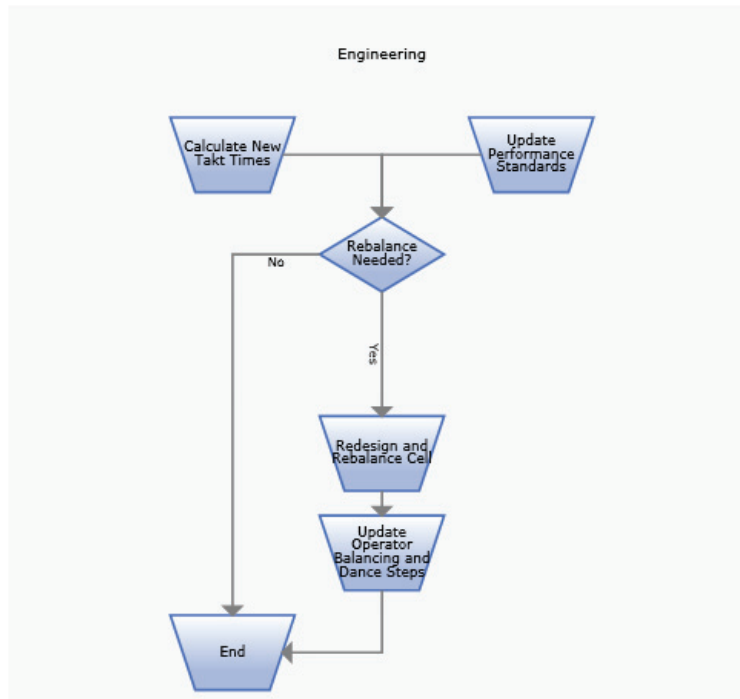

[Plan_8_4.xml]

	A	B	C	D	E	F
1						
2						
3						
4						
5						
6						



Define Manufacturing Systems

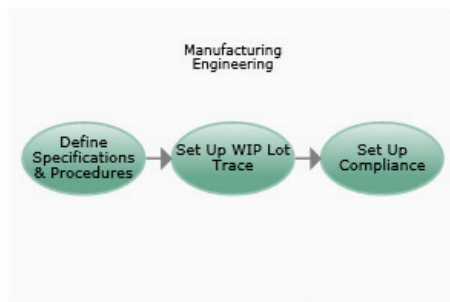

	A	B	C	D	E	F
1						
2						
3						
4						
5						
6						



Define Specifications and Procedures

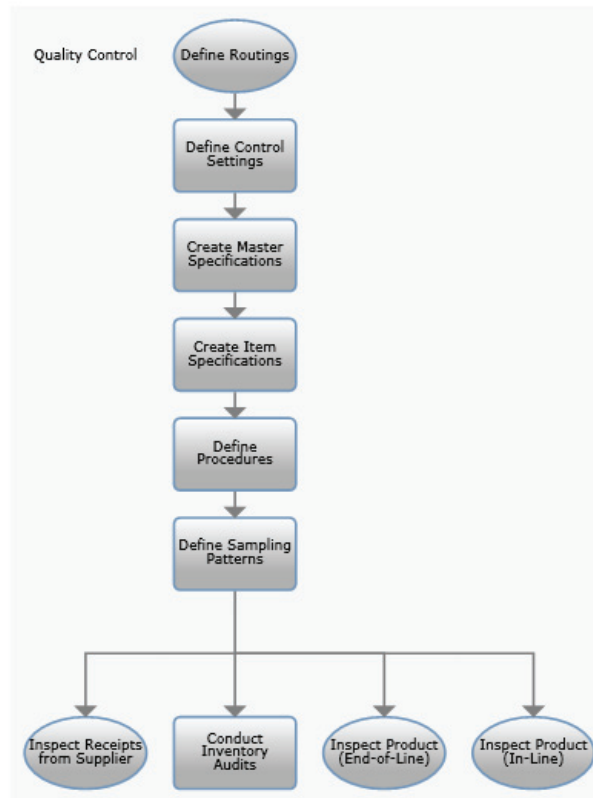

[Warehouse_4_4.xml]

	A	B	C	D	E	F
1						
2						
3						
4						
5						
6						



Set Up WIP Lot Trace

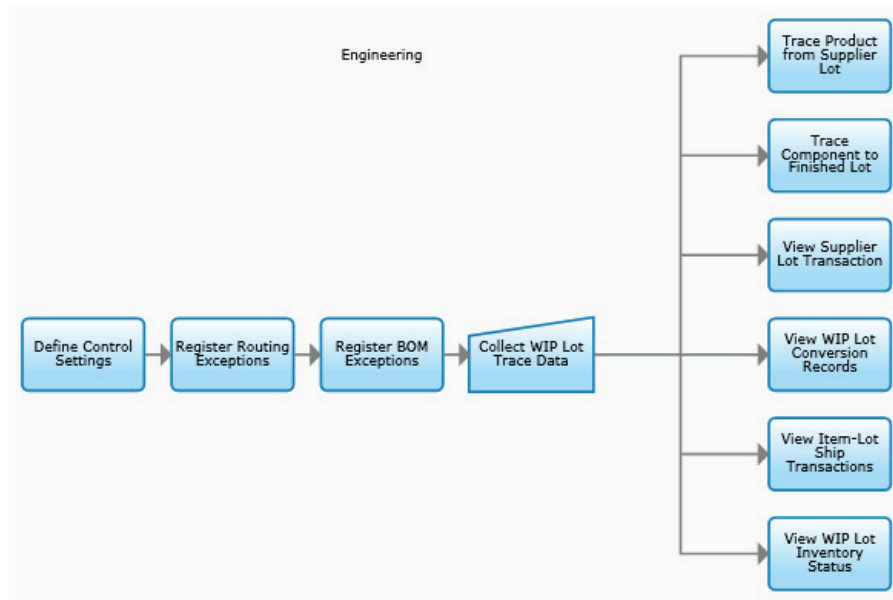

[Setup_3_4.xml]

	A	B	C	D	E	F
1						
2						
3						
4						
5						
6						



Establish Product Costs

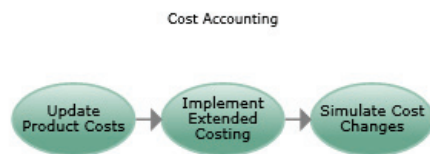

	A	B	C	D	E	F
1						
2						
3						
4						
5						
6						



Update Product Costs

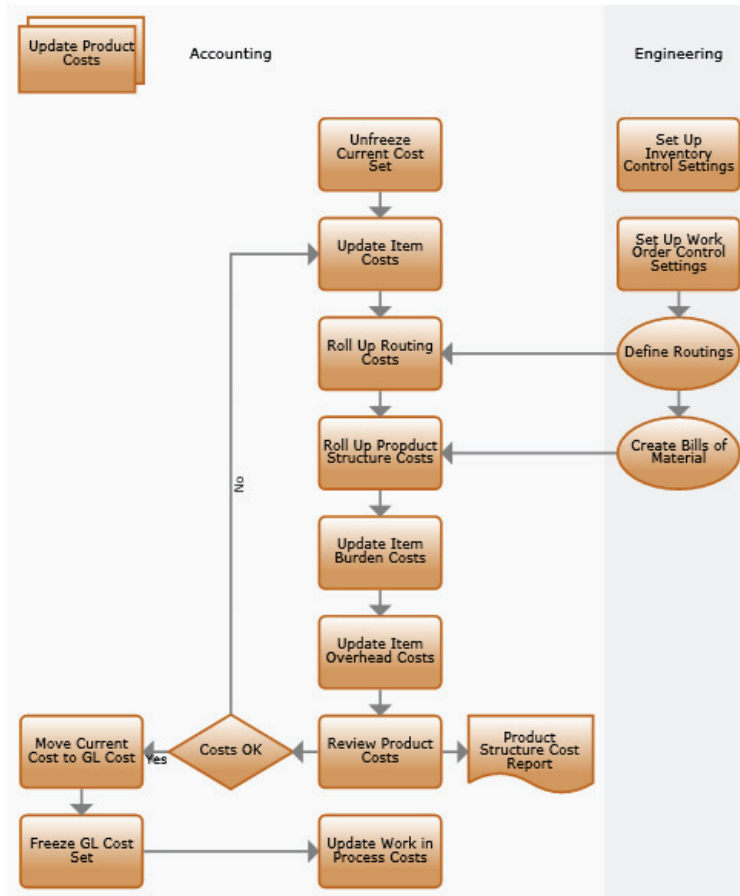

[Finance_5_1.xml]

	A	B	C	D	E	F
1						
2						
3						
4						
5						
6						



Implement Extended Costing

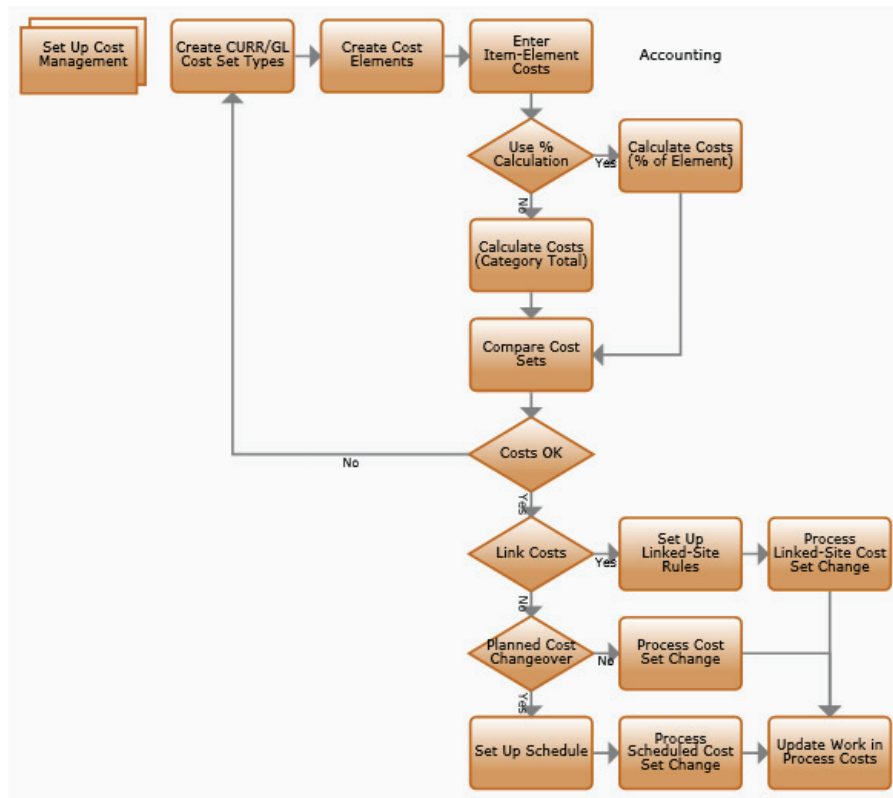

[Finance_5_2.xml]

	A	B	C	D	E	F
1						
2						
3						
4						
5						
6						



Simulate Cost Changes

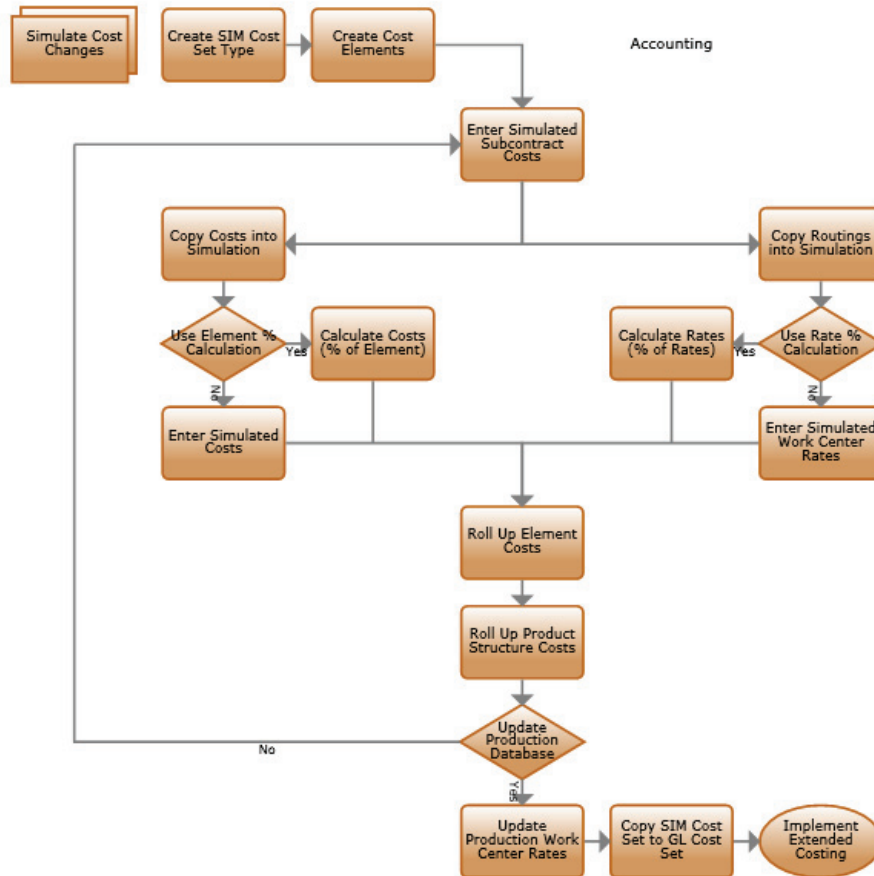

[Finance_5_3.xml]

	A	B	C	D	E	F
1						
2						
3						
4						
5						
6						



Set Up Purchase Order Price Lists

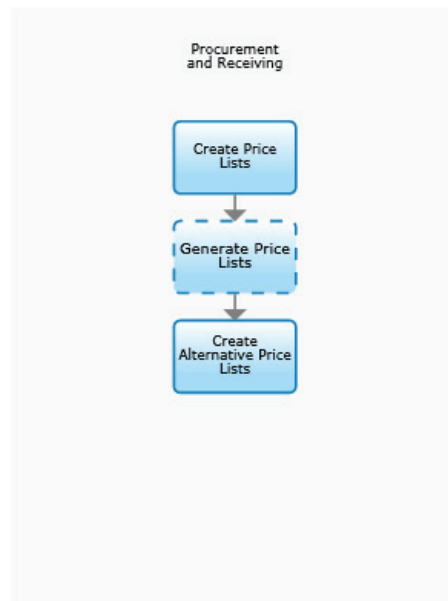

[Setup_7_1.xml]

	A	B	C	D	E	F
1						
2						
3						
4						
5						
6						



The background of the page is a grayscale image of several interlocking gears. The gears are of different sizes and are arranged in a way that they appear to be meshing together. The lighting is soft, creating a sense of depth and texture. The gears are slightly out of focus, giving the image a professional and technical feel.

Chapter 5

Opportunity to Quote Process Maps

This chapter lists the Opportunity to Quote Life Sciences process maps included with QAD Enterprise Applications – Enterprise Edition.

Life Sciences Top Level

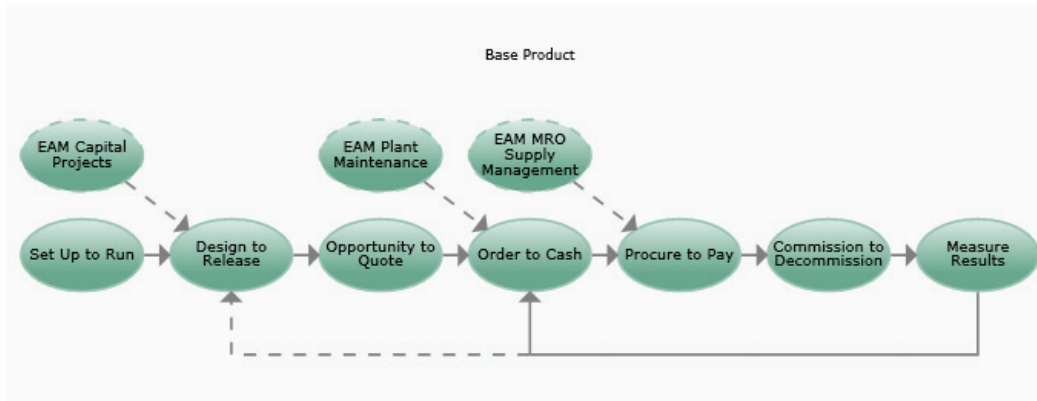

	A	B	C	D	E	F
1						
2						
3						
4						
5						
6						



Opportunity To Quote Top Level

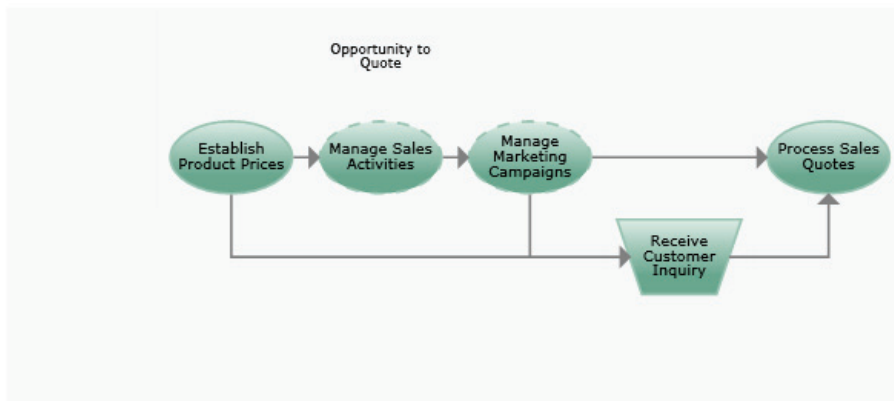

	A	B	C	D	E	F
1						
2						
3						
4						
5						
6						



Establish Product Prices

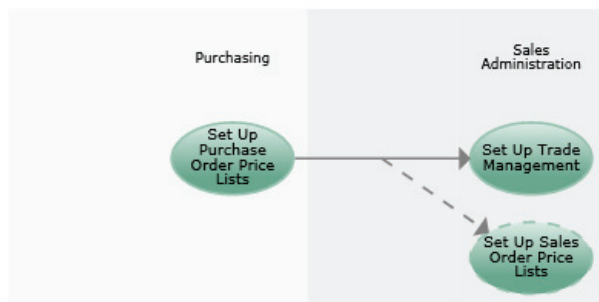

	A	B	C	D	E	F
1						
2						
3						
4						
5						
6						



Set Up Purchase Order Price Lists



[Setup_7_1.xml]

	A	B	C	D	E	F
1						
2						
3						
4						
5						
6						



Setup Sales Order Price Lists

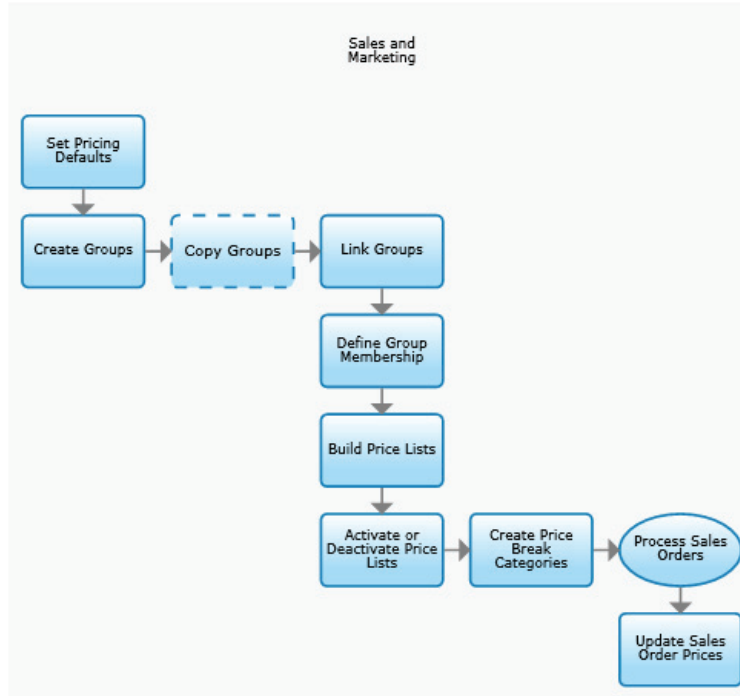

[Setup_7_2.xml]

	A	B	C	D	E	F
1						
2						
3						
4						
5						
6						



Manage Marketing Campaigns

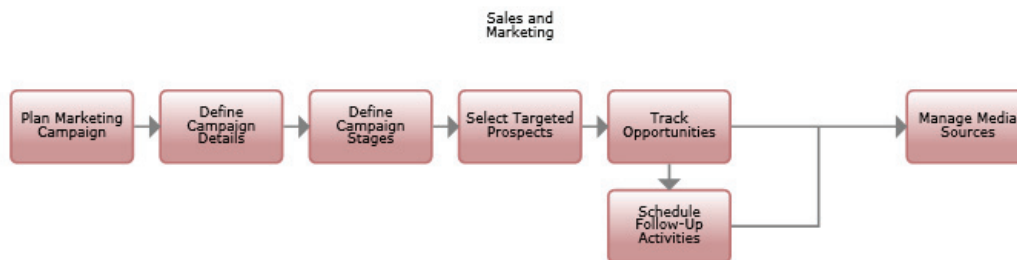

	A	B	C	D	E	F
1						
2						
3						
4						
5						
6						



Process Sales Quotes

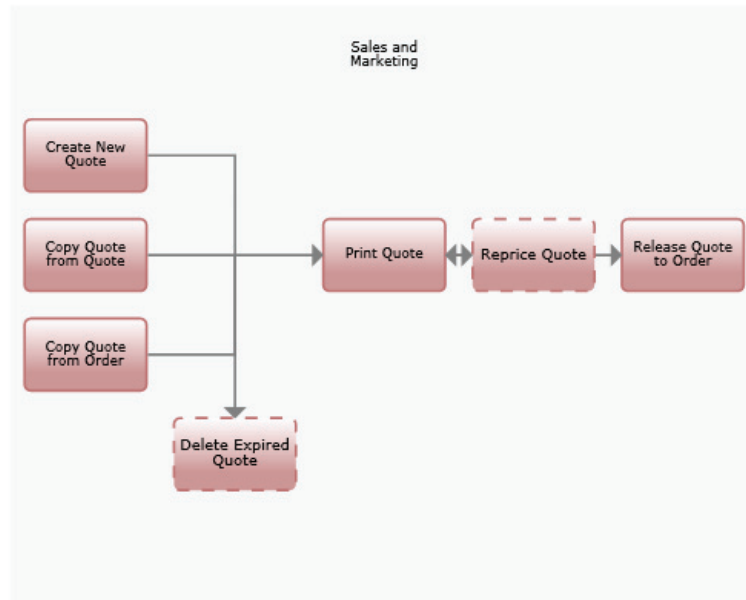

[Deliver_0_4.xml]

	A	B	C	D	E	F
1						
2						
3						
4						
5						
6						



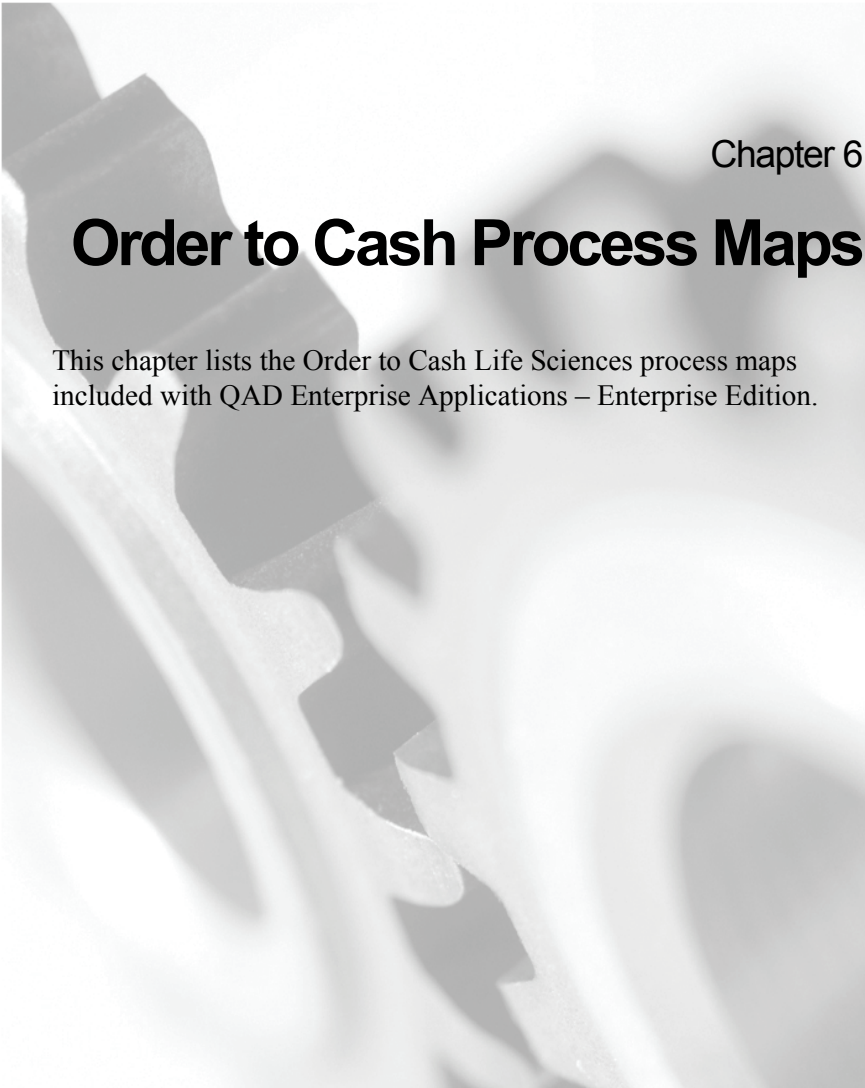

Chapter 6

Order to Cash Process Maps

This chapter lists the Order to Cash Life Sciences process maps included with QAD Enterprise Applications – Enterprise Edition.

Life Sciences Top Level

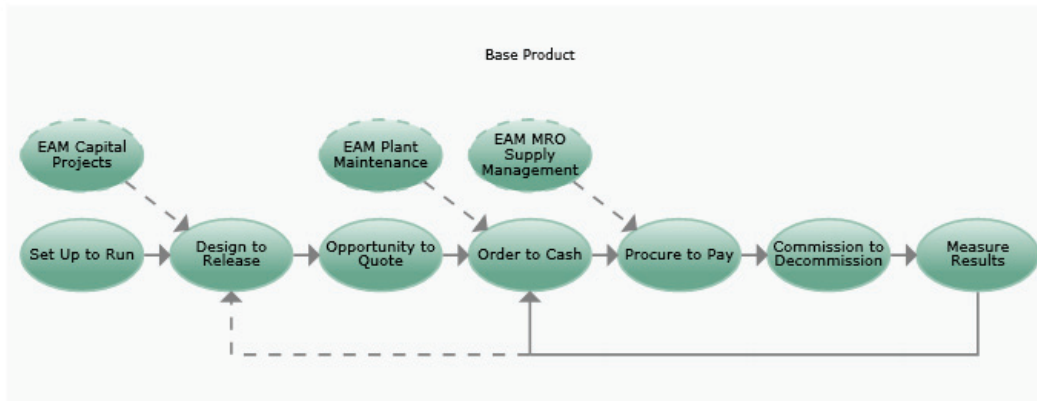

	A	B	C	D	E	F
1						
2						
3						
4						
5						
6						



Order to Cash Top Level

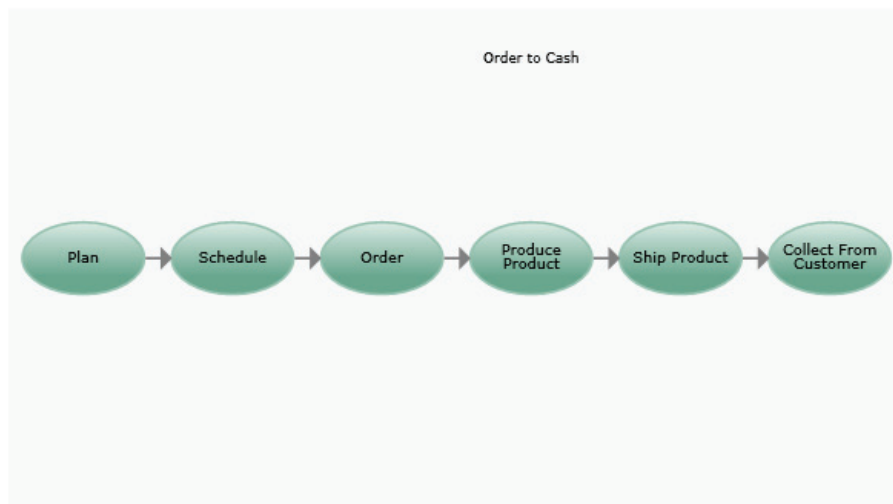

	A	B	C	D	E	F
1						
2						
3						
4						
5						
6						



Plan

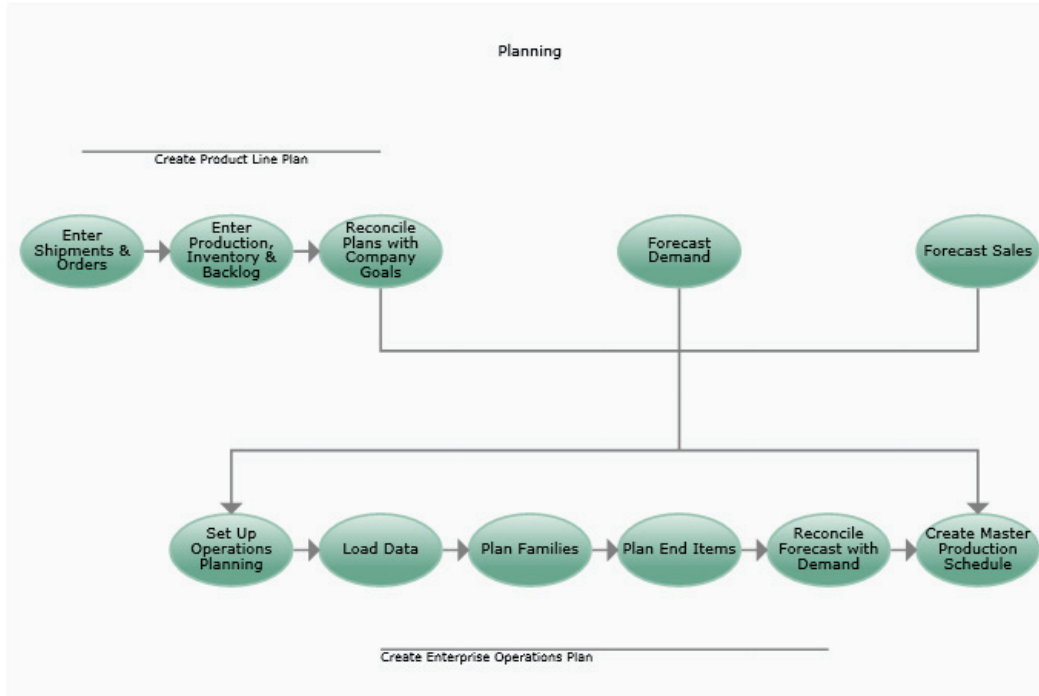

	A	B	C	D	E	F
1						
2						
3						
4						
5						
6						



Enter Shipments and Orders

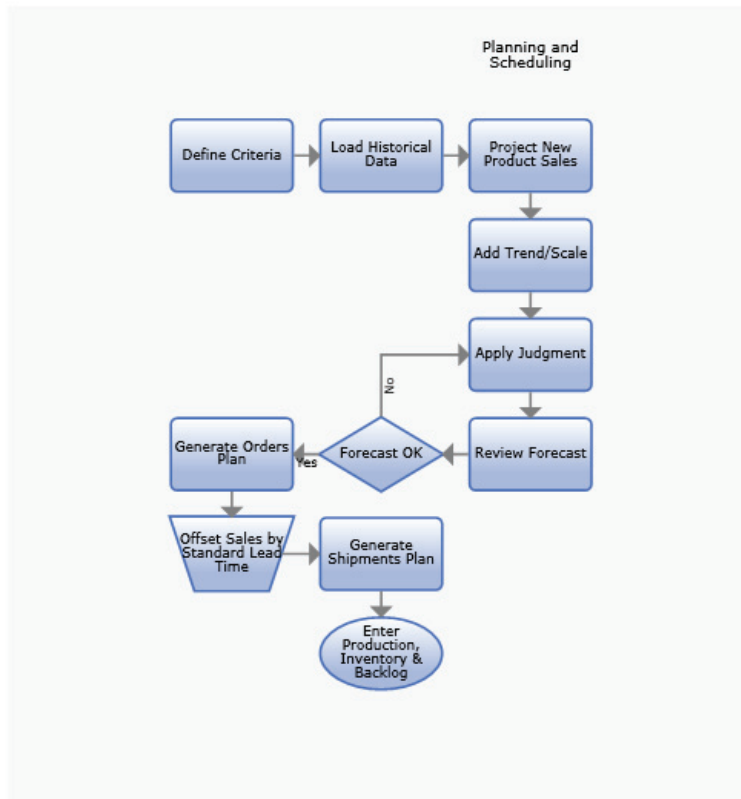

[Plan_1_1.xml]

	A	B	C	D	E	F
1						
2						
3						
4						
5						
6						



Enter Production, Inventory, and Backlog

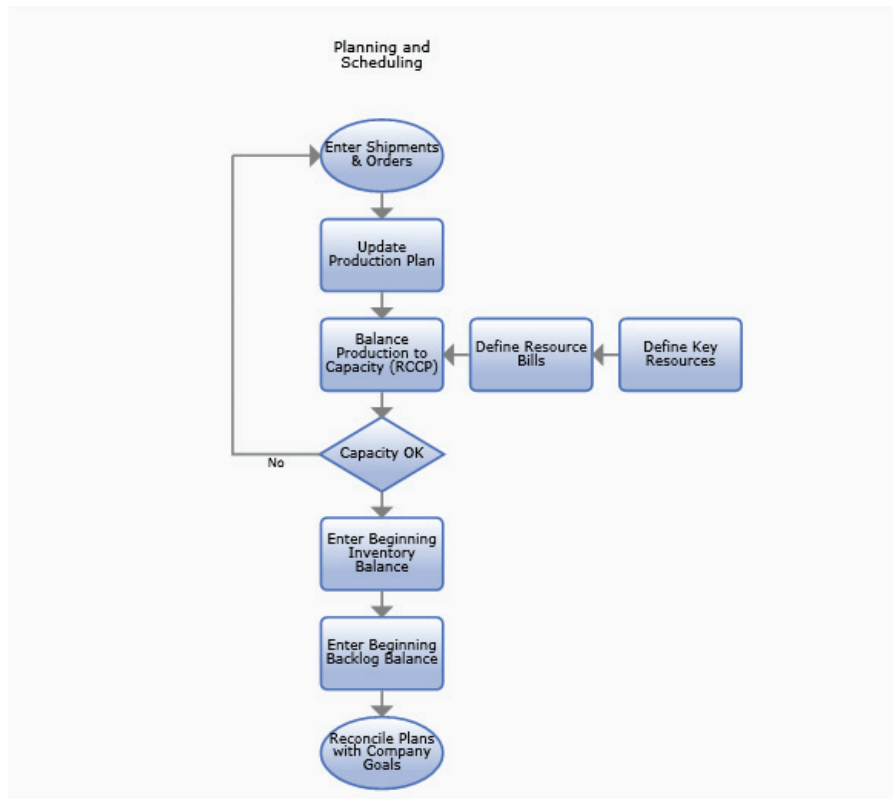

[Plan_1_2.xml]

	A	B	C	D	E	F
1						
2						
3						
4						
5						
6						



Reconcile Plans with Company Goals

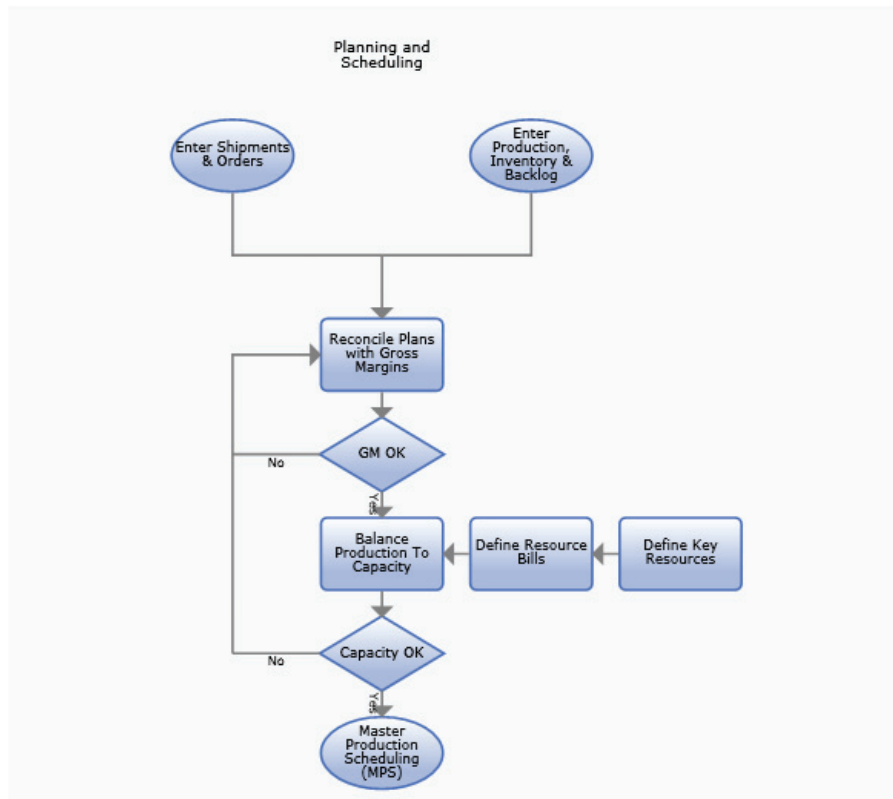

[Plan_1_3.xml]

	A	B	C	D	E	F
1						
2						
3						
4						
5						
6						



Set Up Operations Planning

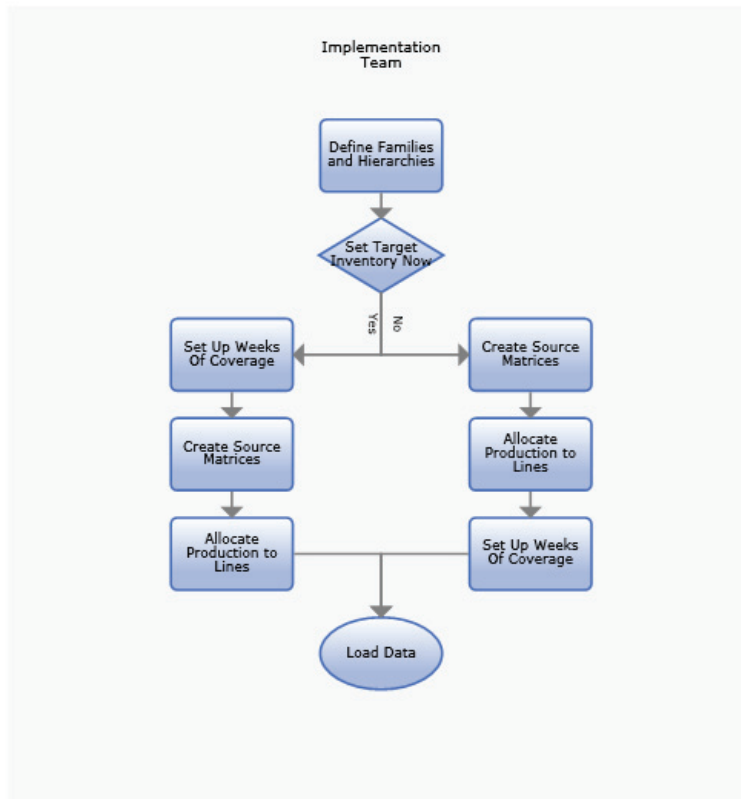

[Plan_0_1.xml]

	A	B	C	D	E	F
1						
2						
3						
4						
5						
6						



Load Data

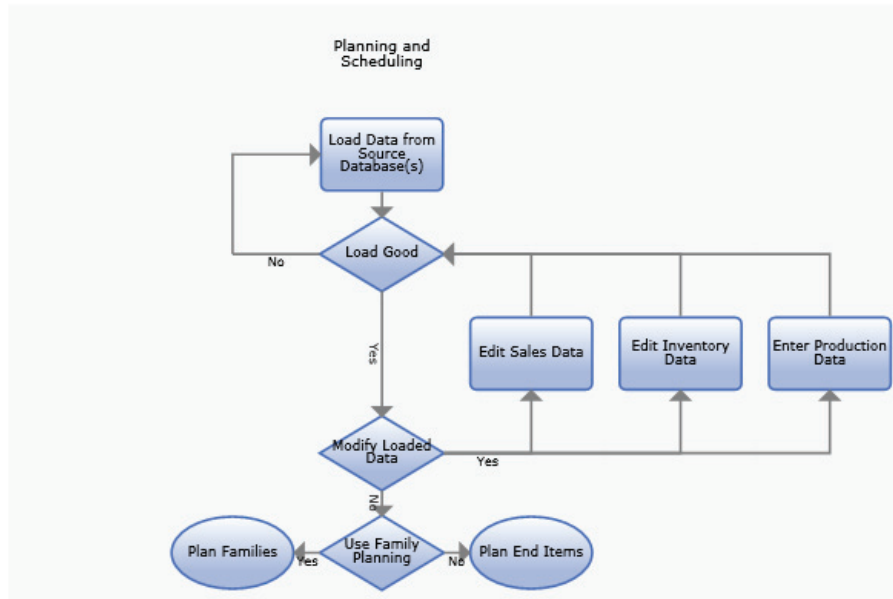

[Plan_0_2.xml]

	A	B	C	D	E	F
1						
2						
3						
4						
5						
6						



Plan Families

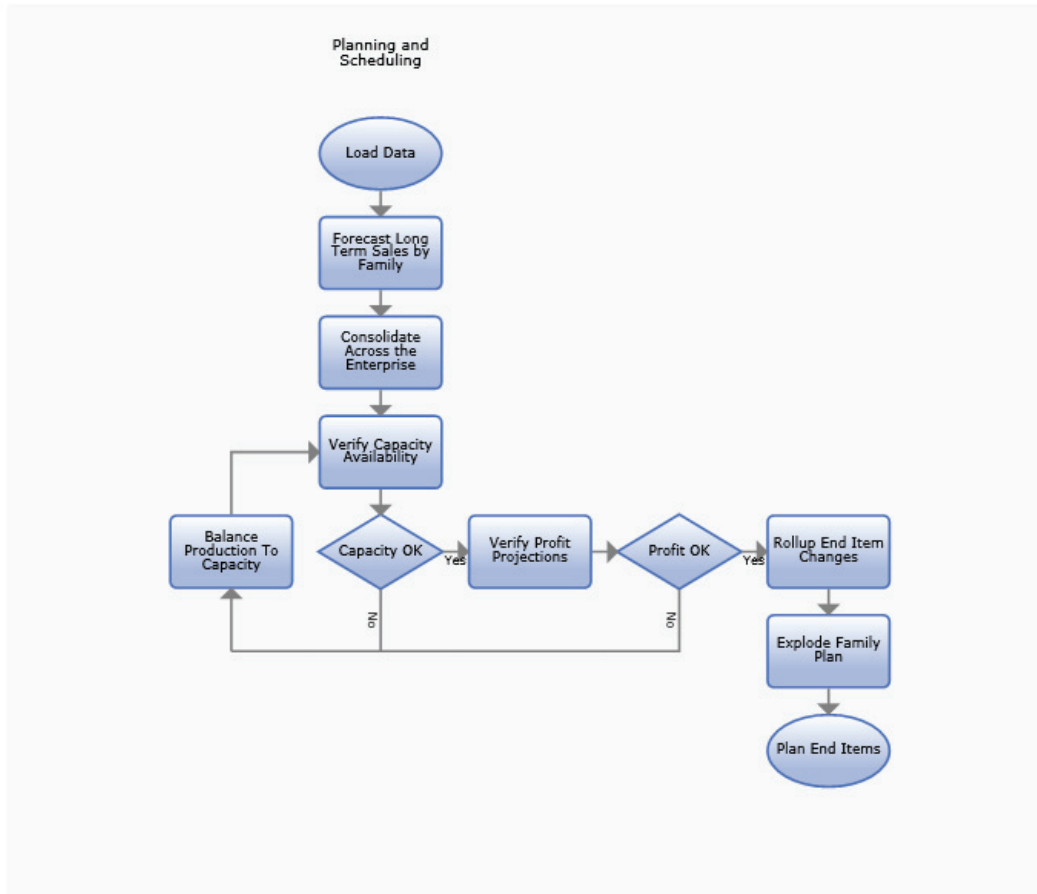

[Plan_0_3.xml]

	A	B	C	D	E	F
1						
2						
3						
4						
5						
6						



Plan End Items

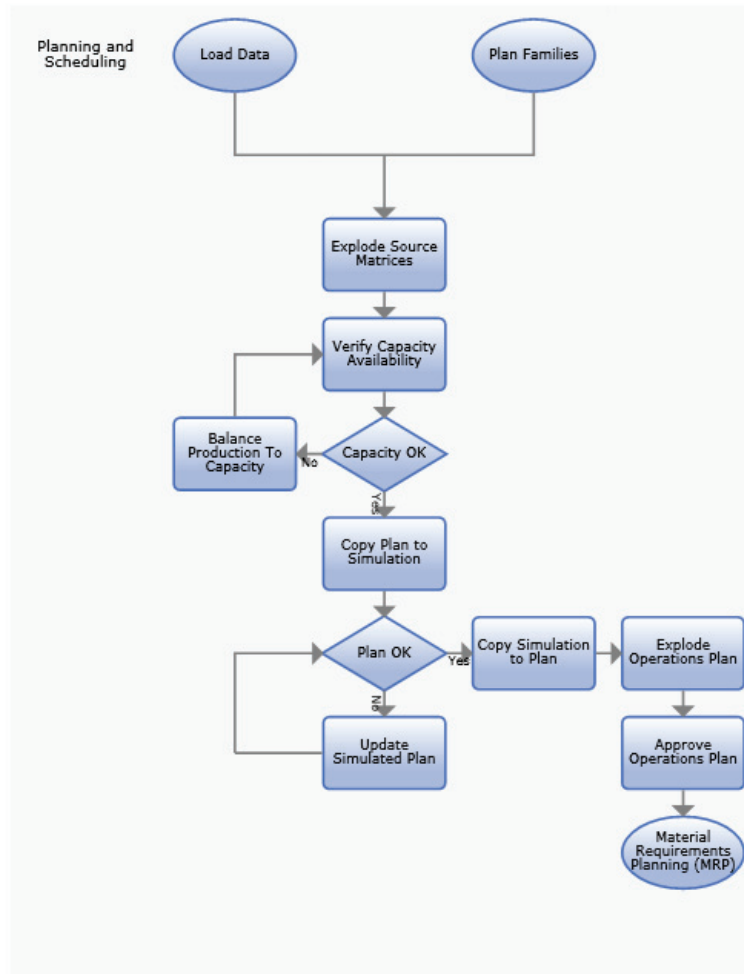

[Plan_0_4.xml]

	A	B	C	D	E	F
1						
2						
3						
4						
5						
6						



Reconcile Detailed Forecasts with S&OP Demand

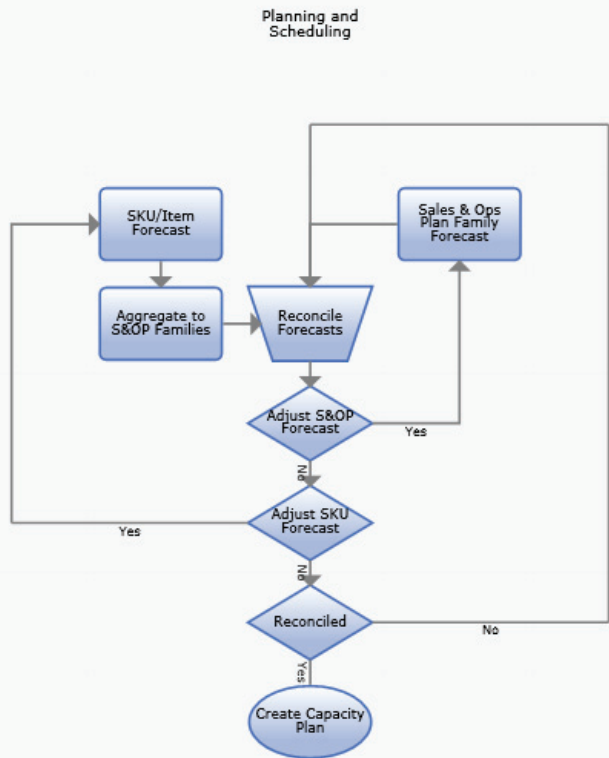

[Plan_2_3.xml]

	A	B	C	D	E	F
1						
2						
3						
4						
5						
6						



Create Master Production Schedule

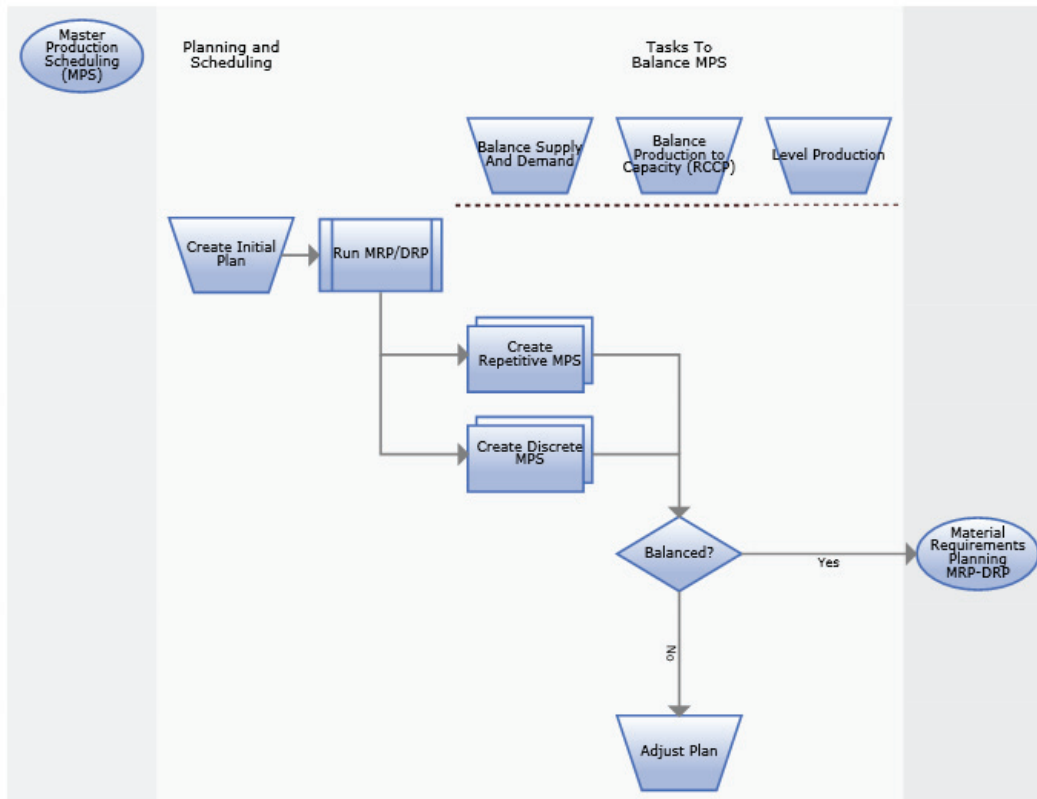

[Plan_2_2.xml]

	A	B	C	D	E	F
1						
2						
3						
4						
5						
6						



Forecast Demand

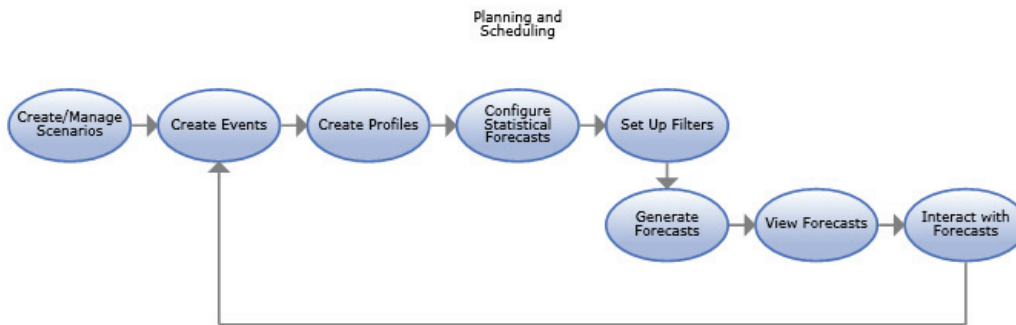

[Plan_6_2.xml]

	A	B	C	D	E	F
1						
2						
3						
4						
5						
6						



Forecast Sales

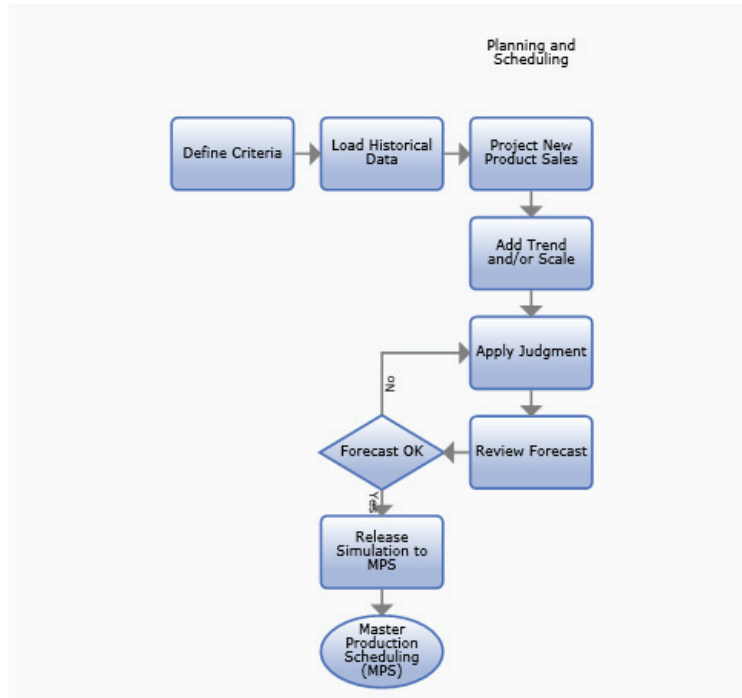

[Plan_6_1.xml]

	A	B	C	D	E	F
1						
2						
3						
4						
5						
6						



Schedule

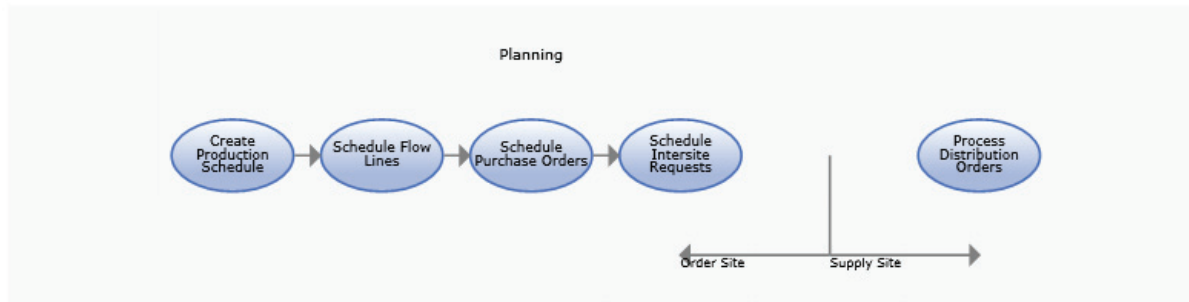

	A	B	C	D	E	F
1						
2						
3						
4						
5						
6						



Schedule Purchase Orders

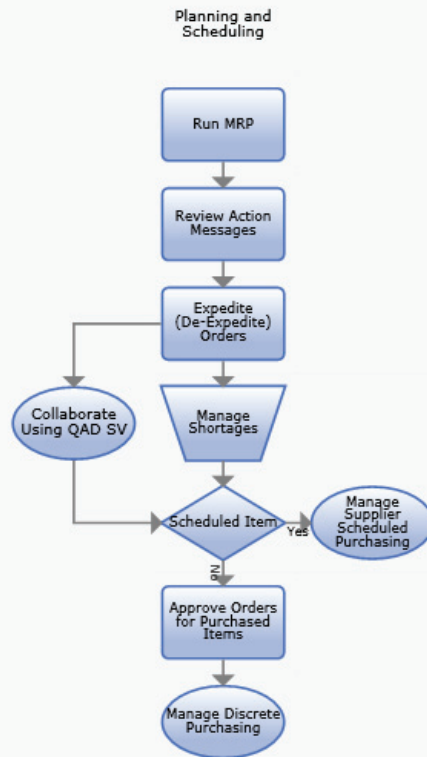

[Plan_4_1.xml]

	A	B	C	D	E	F
1						
2						
3						
4						
5						
6						



Schedule Discrete Orders

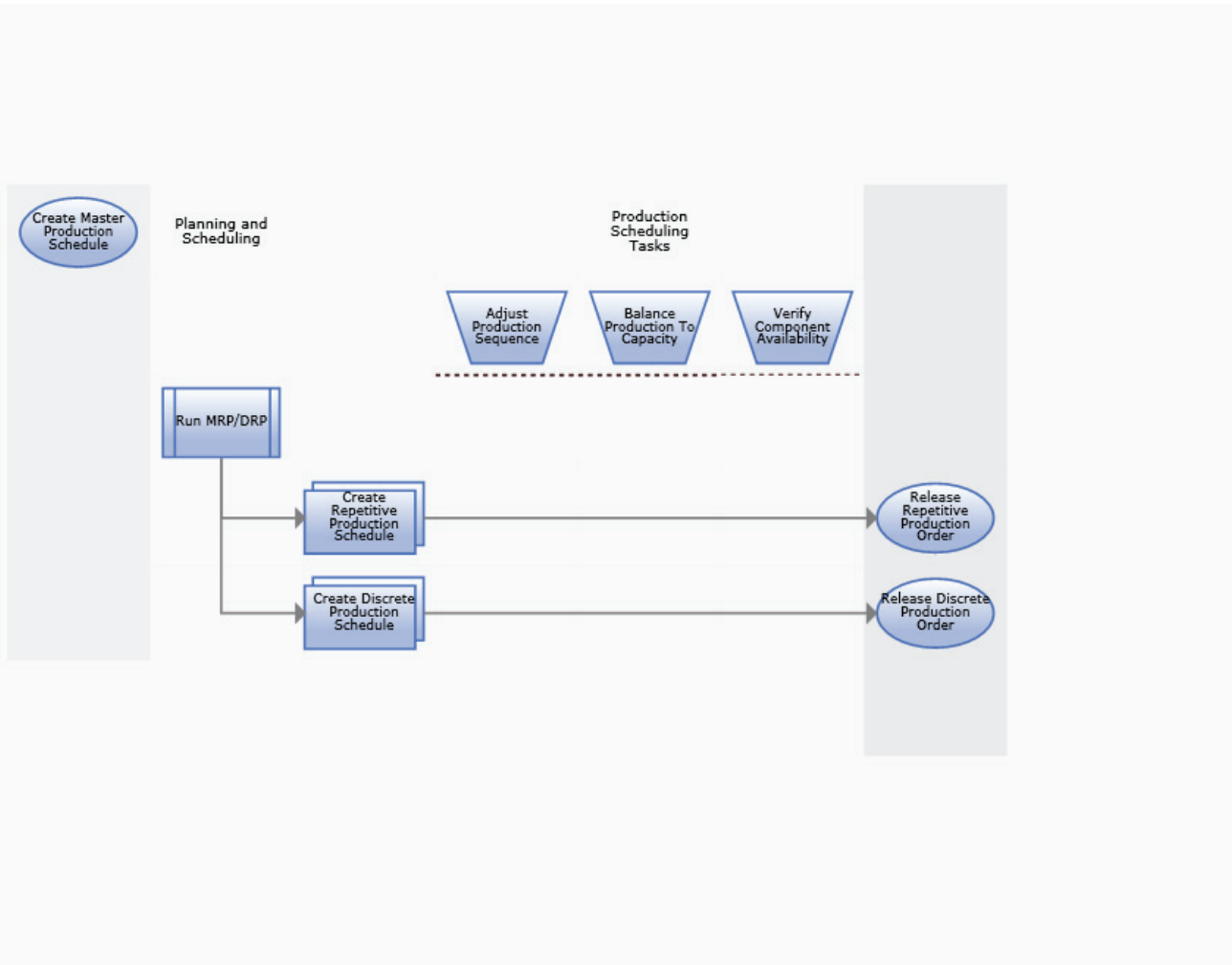

	A	B	C	D	E	F
1						
2						
3						
4						
5						
6						



Create Capacity Plan

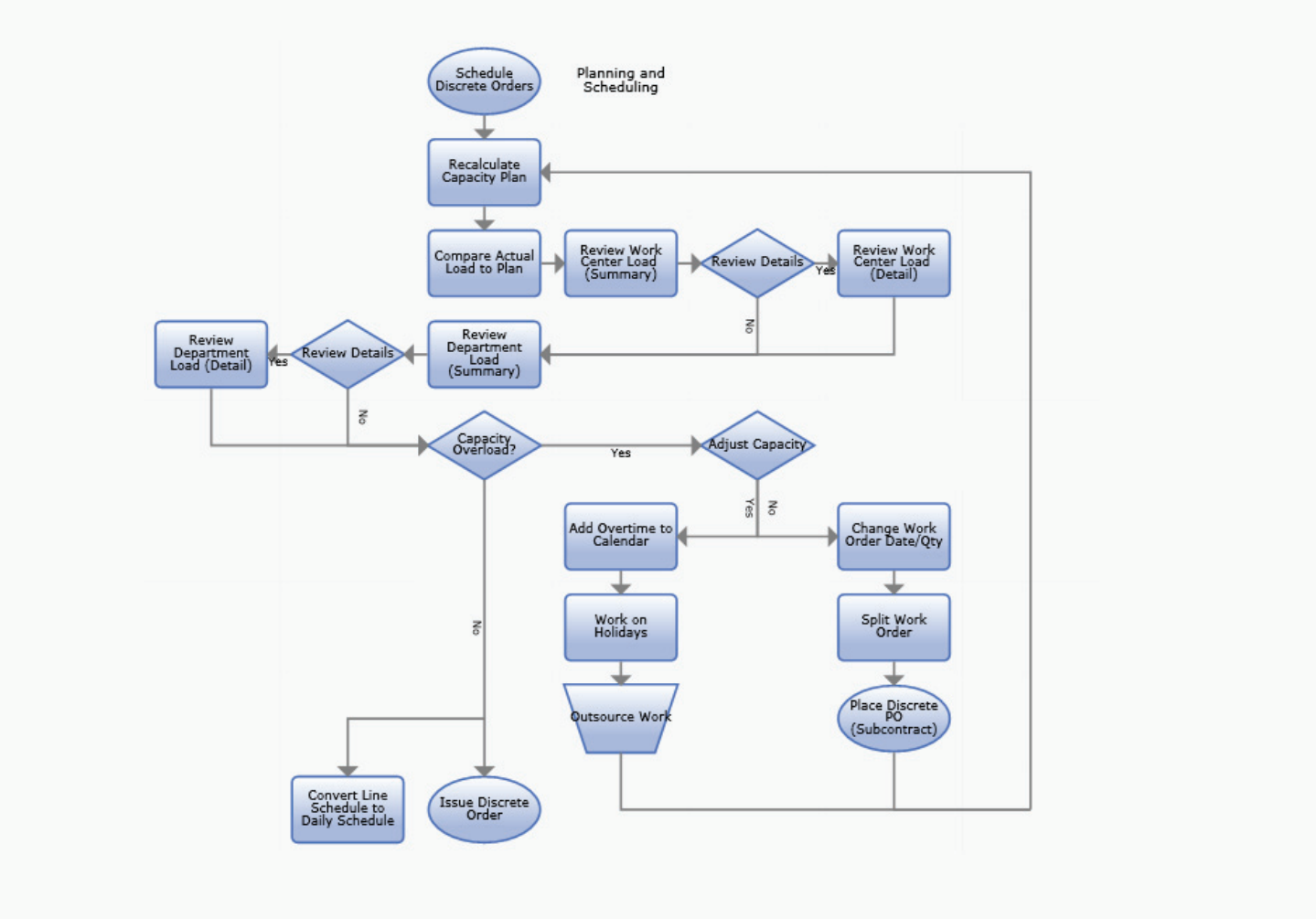

[Plan_3_1.xml]

	A	B	C	D	E	F
1						
2						
3						
4						
5						
6						



Schedule Lean Manufacturing

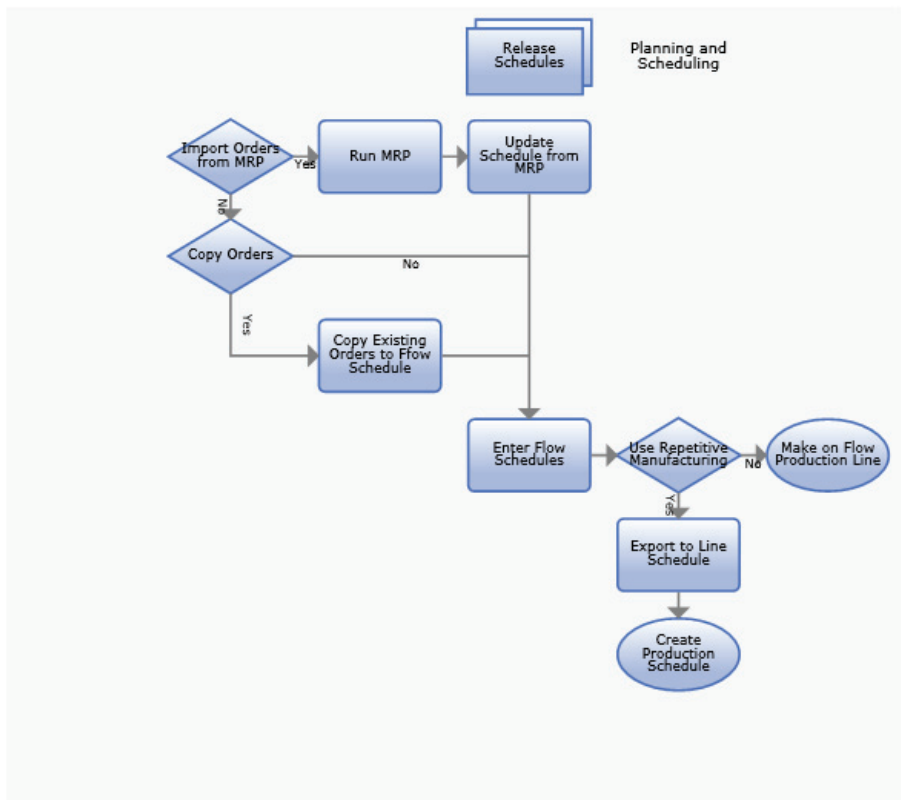

[Plan_4_5.xml]

	A	B	C	D	E	F
1						
2						
3						
4						
5						
6						



Schedule Intersite Requests

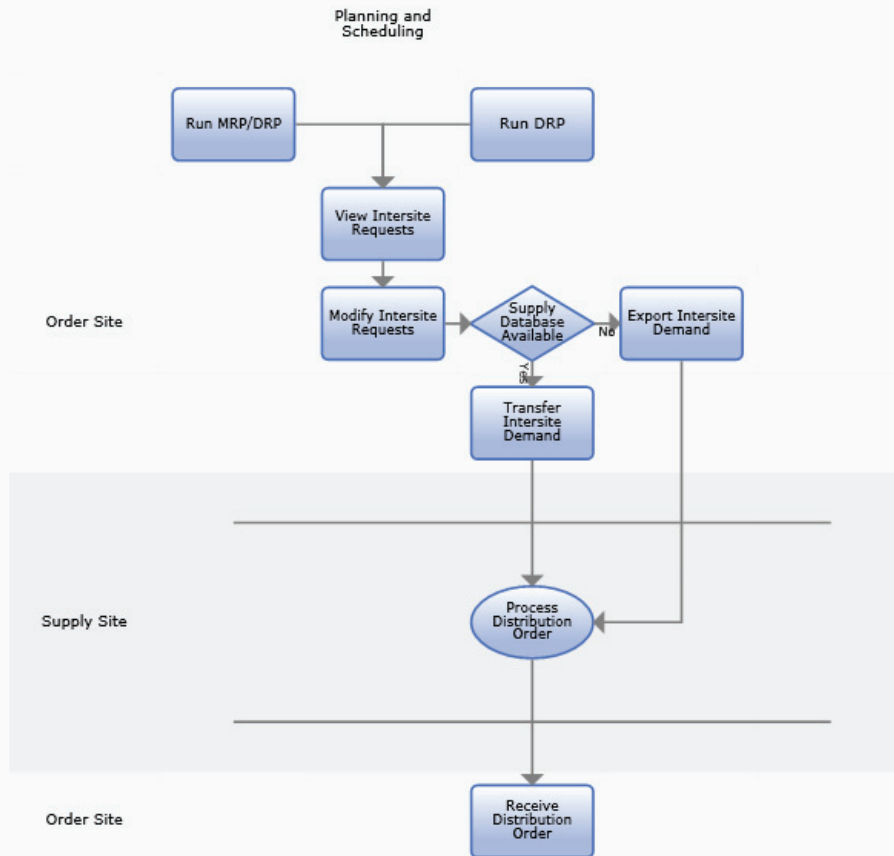

[Plan_4_3.xml]

	A	B	C	D	E	F
1						
2						
3						
4						
5						
6						



Process Distribution Orders

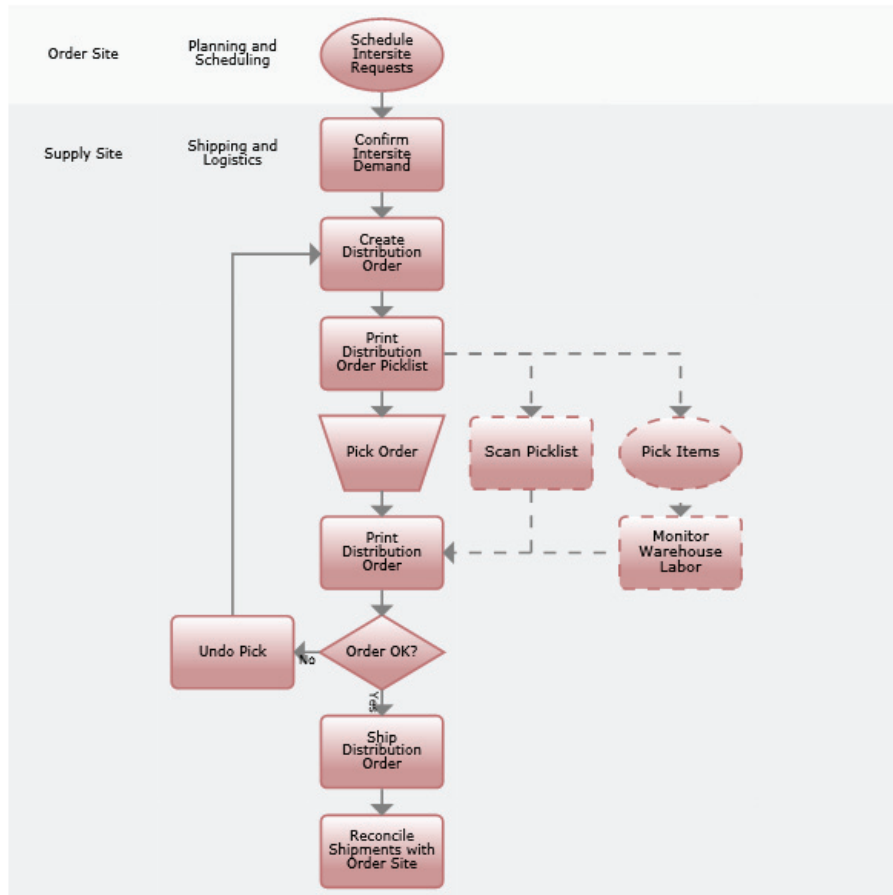

[Deliver_1_5.xml]

	A	B	C	D	E	F
1						
2						
3						
4						
5						
6						



Order

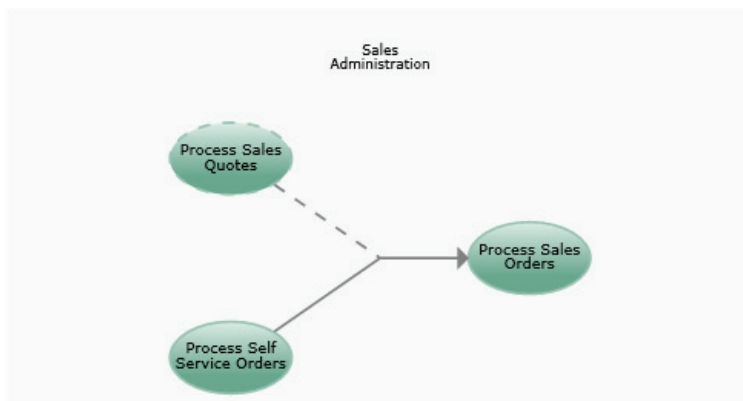

	A	B	C	D	E	F
1						
2						
3						
4						
5						
6						



Process Sales Quotes

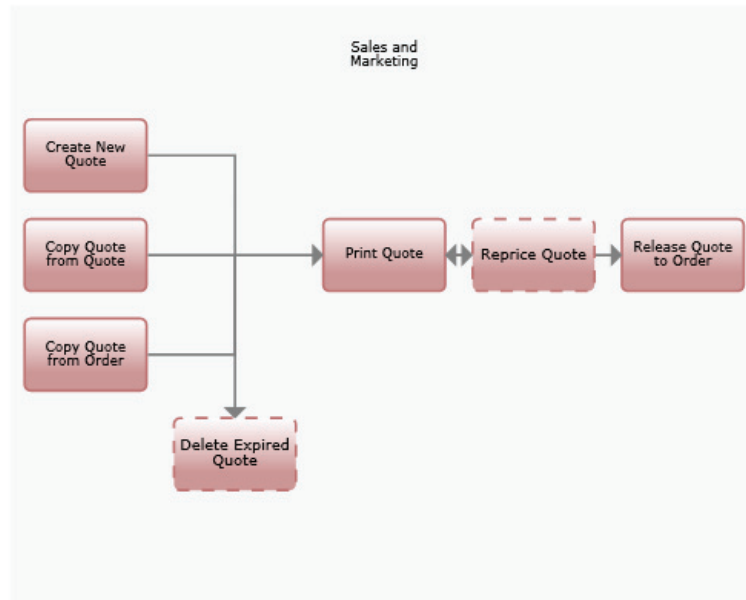

[Deliver_0_4.xml]

	A	B	C	D	E	F
1						
2						
3						
4						
5						
6						



Process Sales Orders

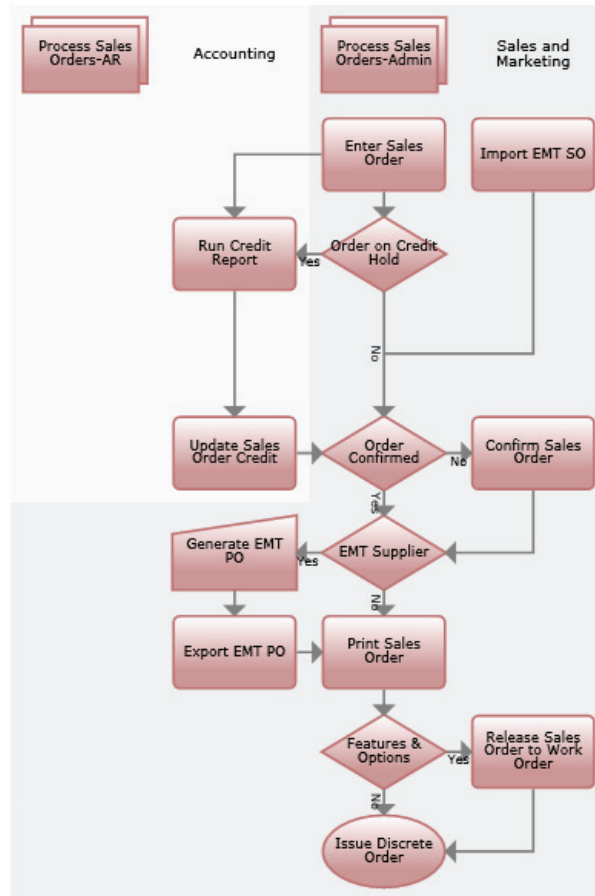

[Deliver_1_1.xml]

	A	B	C	D	E	F
1						
2						
3						
4						
5						
6						



Produce Product

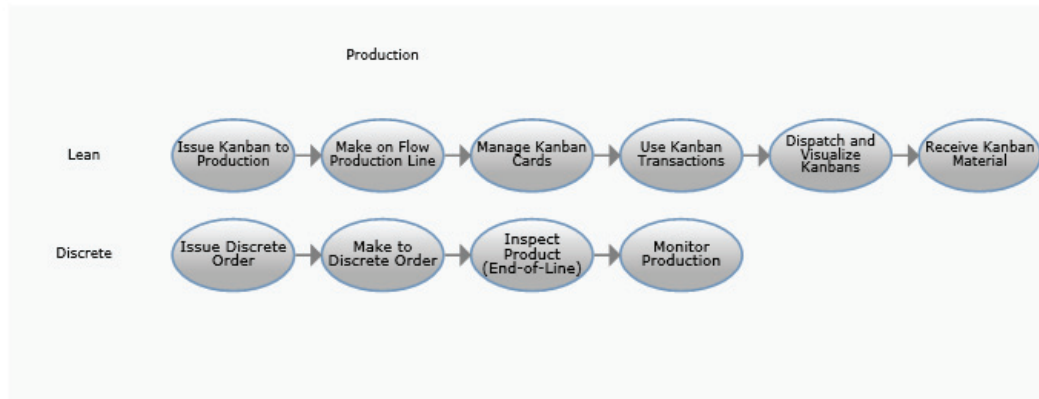

	A	B	C	D	E	F
1						
2						
3						
4						
5						
6						



Repetitive Issue Repetitive Picklist

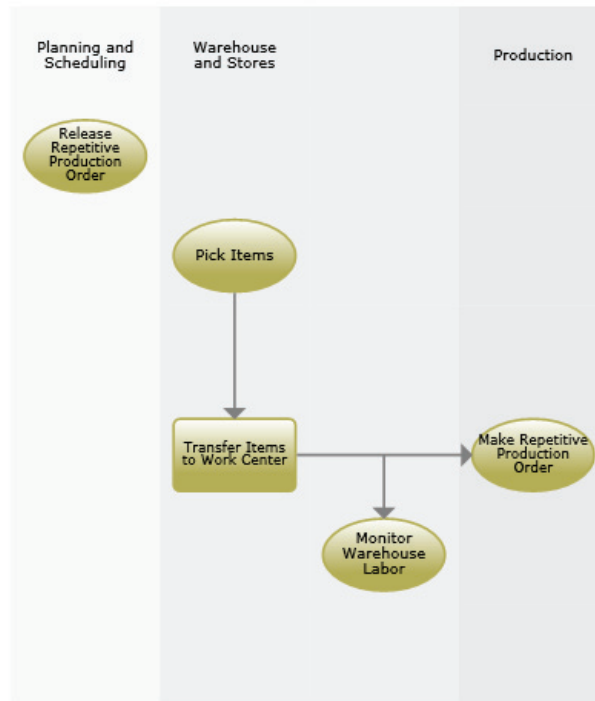

[Warehouse_2_5.xml]

	A	B	C	D	E	F
1						
2						
3						
4						
5						
6						



Make On Repetitive Line



[Make_3_4.xml]

	A	B	C	D	E	F
1						
2						
3						
4						
5						
6						



Manage Subcontract Purchasing

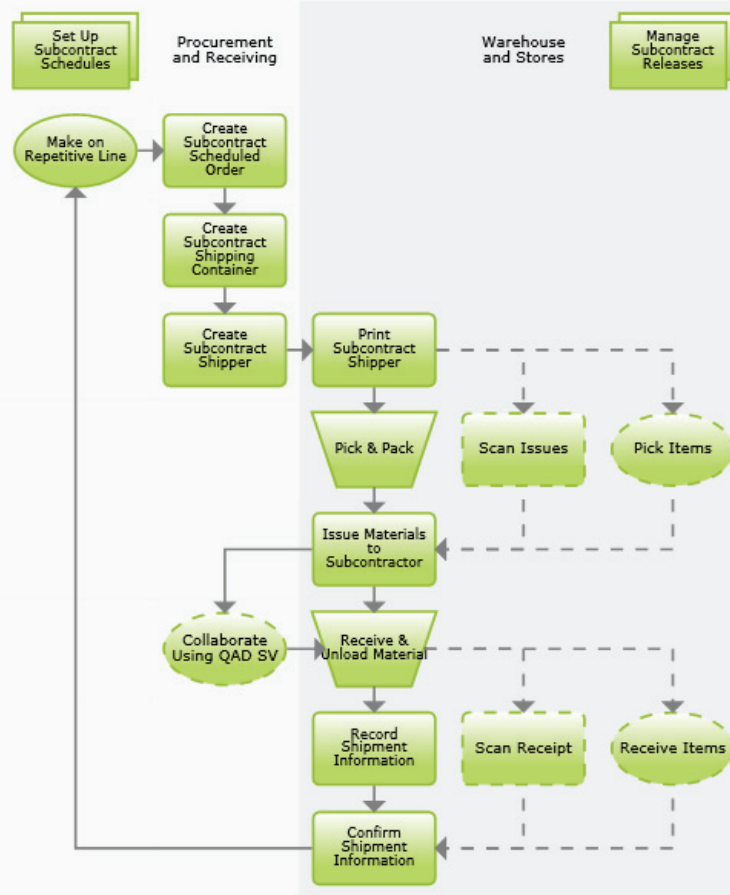

[Source_2_8.xml]

	A	B	C	D	E	F
1						
2						
3						
4						
5						
6						



Inspect Product In-Line

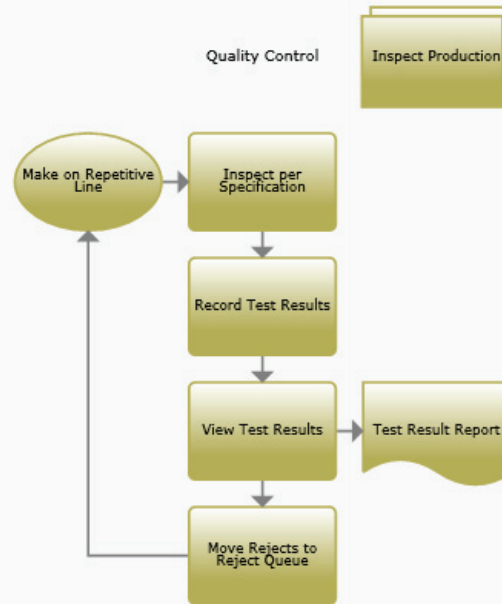

[Warehouse_4_3.xml]

	A	B	C	D	E	F
1						
2						
3						
4						
5						
6						



Discrete

Issue Discrete Order

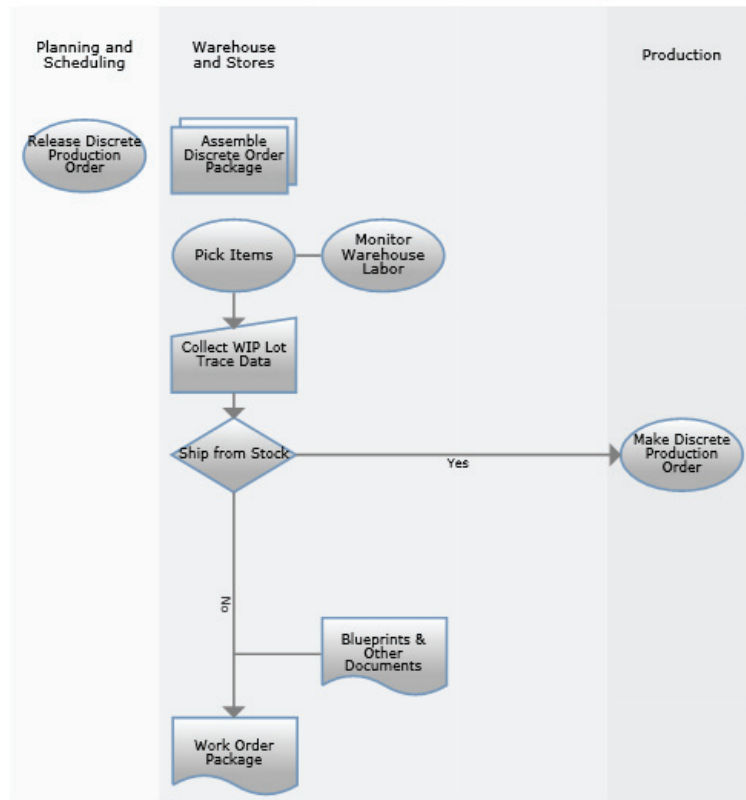

[Warehouse_2_1.xml]

	A	B	C	D	E	F
1						
2						
3						
4						
5						
6						



Pick Items

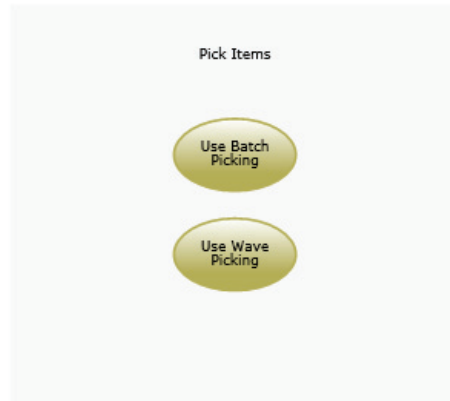

[Warehouse_6_4.xml]

	A	B	C	D	E	F
1						
2						
3						
4						
5						
6						



Use Batch Picking

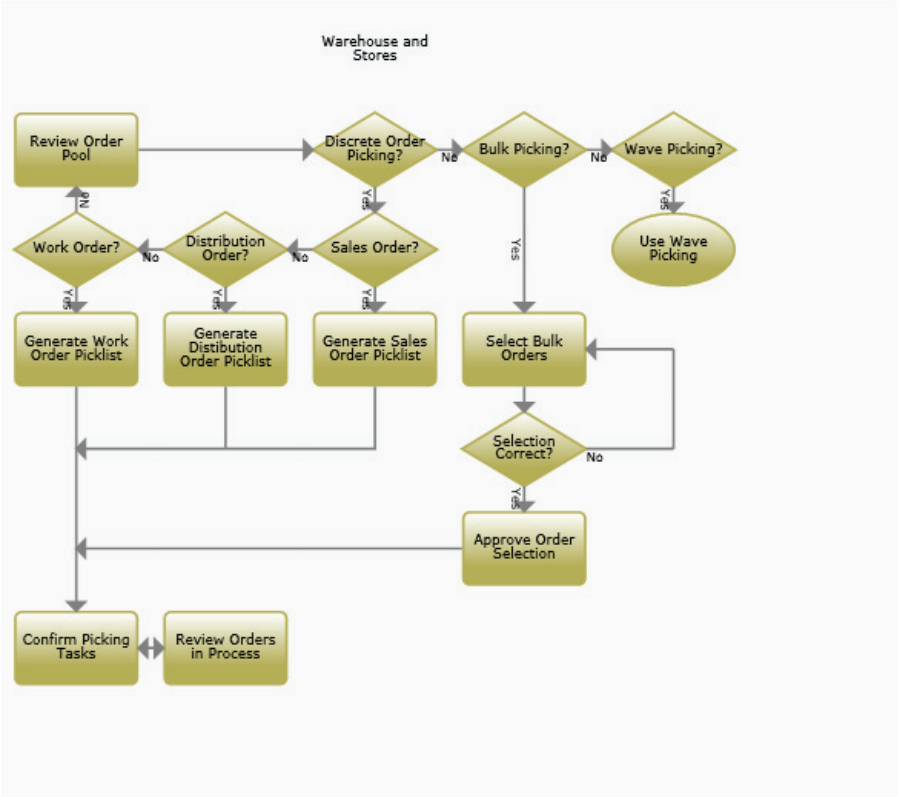

[Warehouse_6_4_1.xml]

	A	B	C	D	E	F
1						
2						
3						
4						
5						
6						



Use Wave Picking

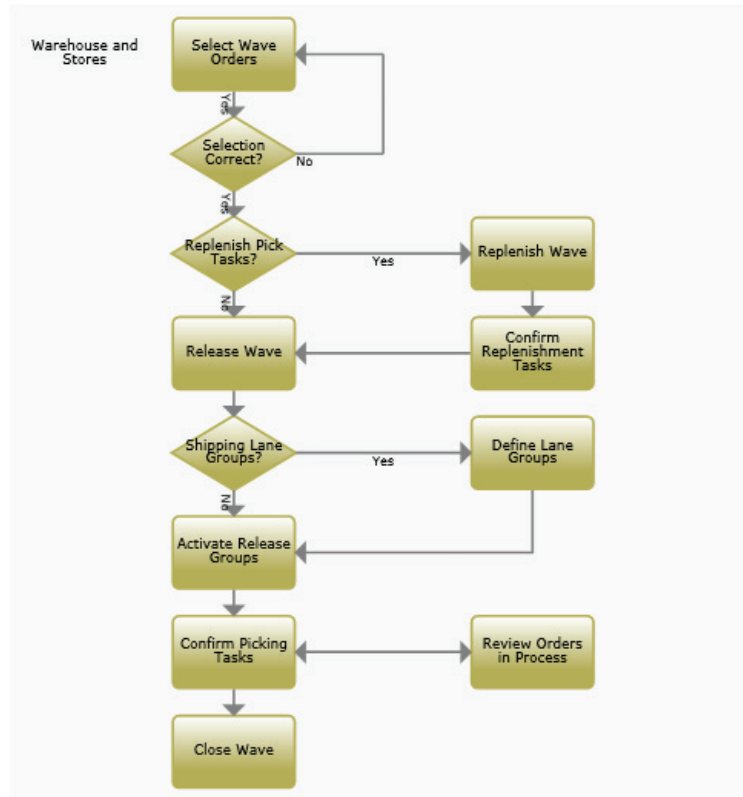

[Warehouse_6_4_2.xml]

	A	B	C	D	E	F
1						
2						
3						
4						
5						
6						



Make to Discrete Order

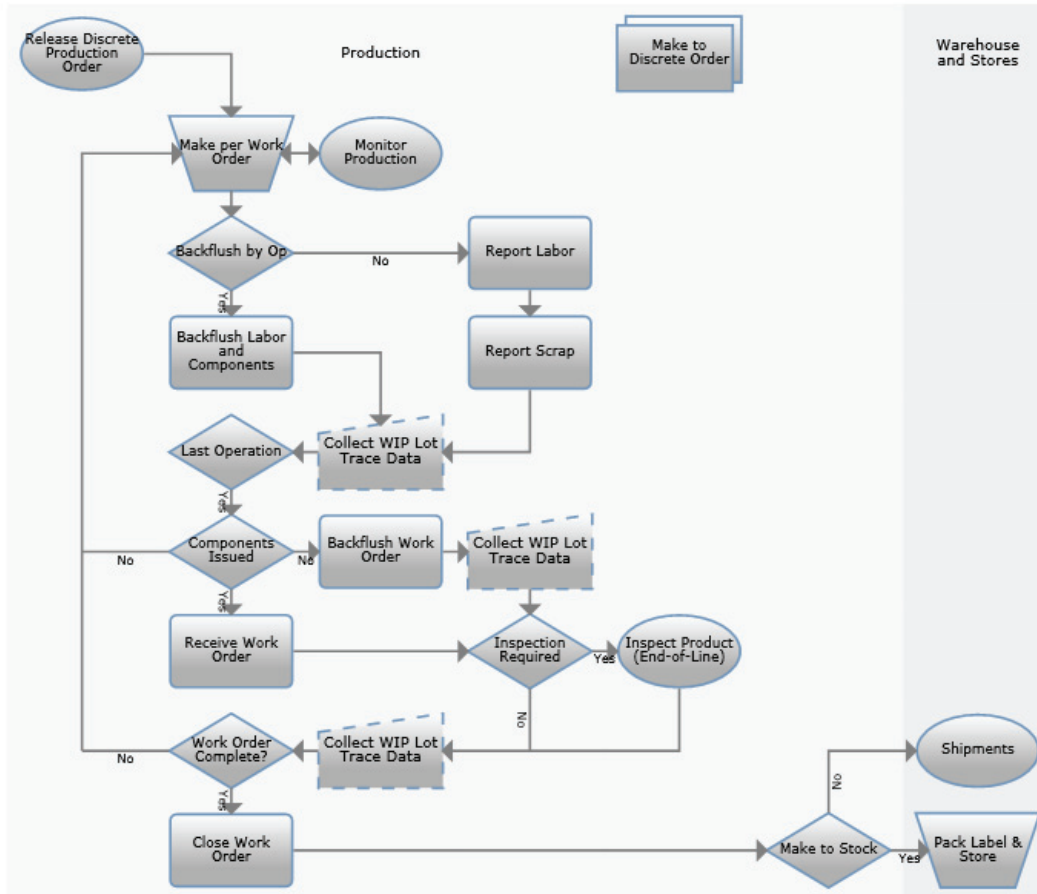

[Make_2_2.xml]

	A	B	C	D	E	F
1						
2						
3						
4						
5						
6						



Inspect Product (End-of-Line)

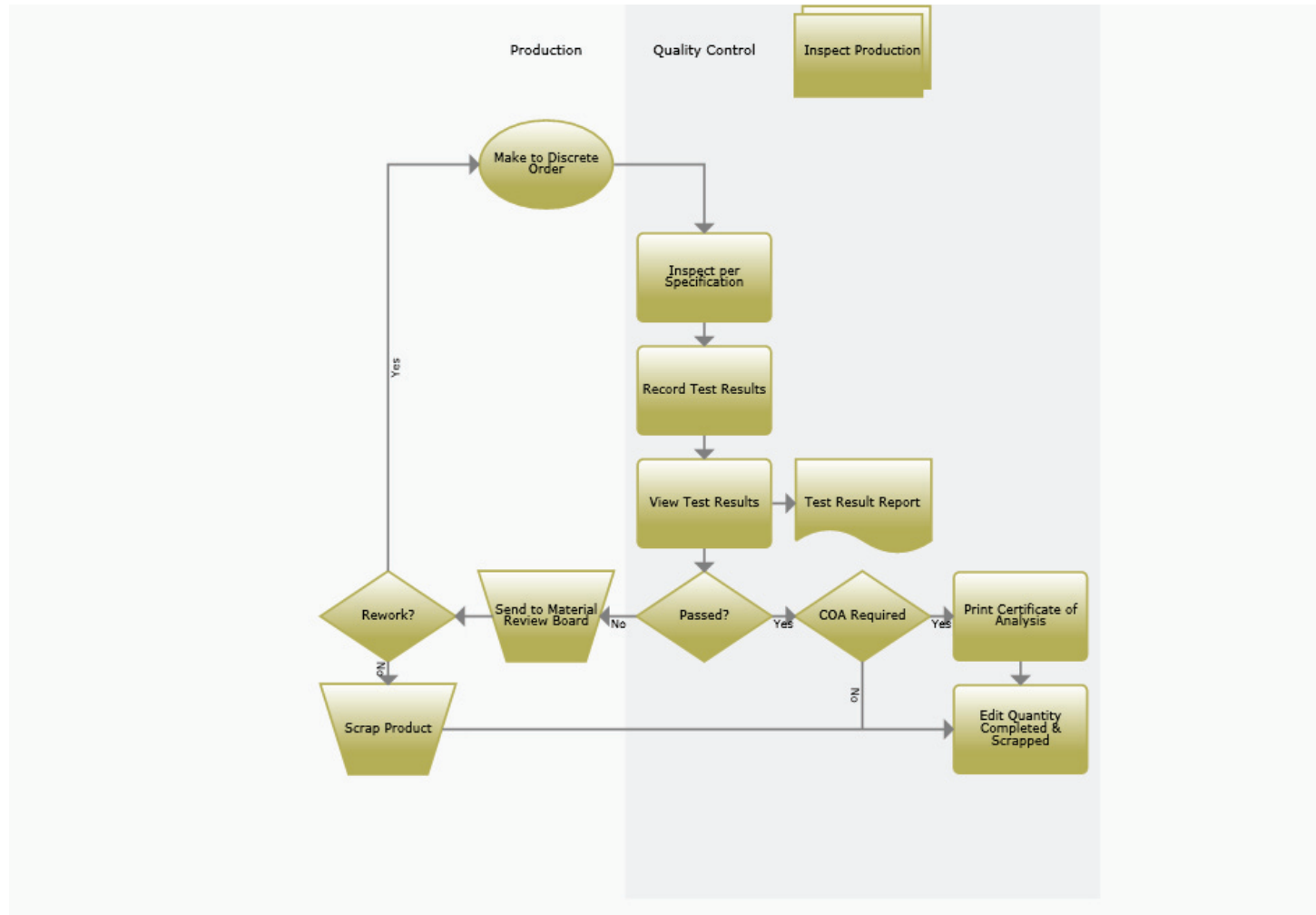

[Warehouse_4_2.xml]

	A	B	C	D	E	F
1						
2						
3						
4						
5						
6						



Monitor Production

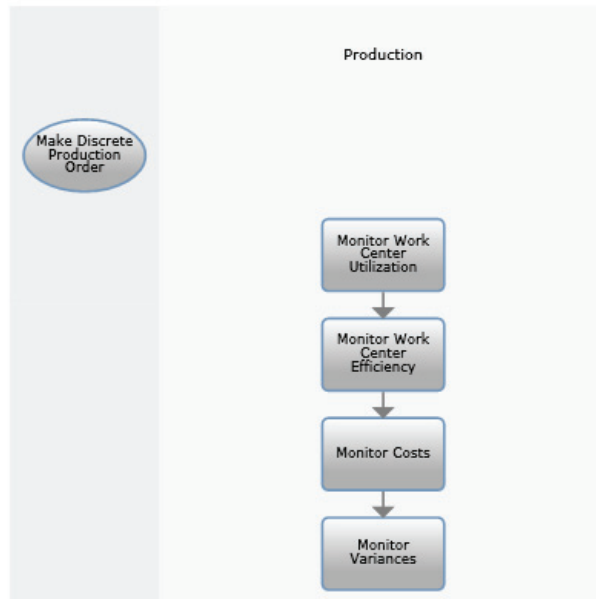

[Make_2_3.xml]

	A	B	C	D	E	F
1						
2						
3						
4						
5						
6						



Ship Product

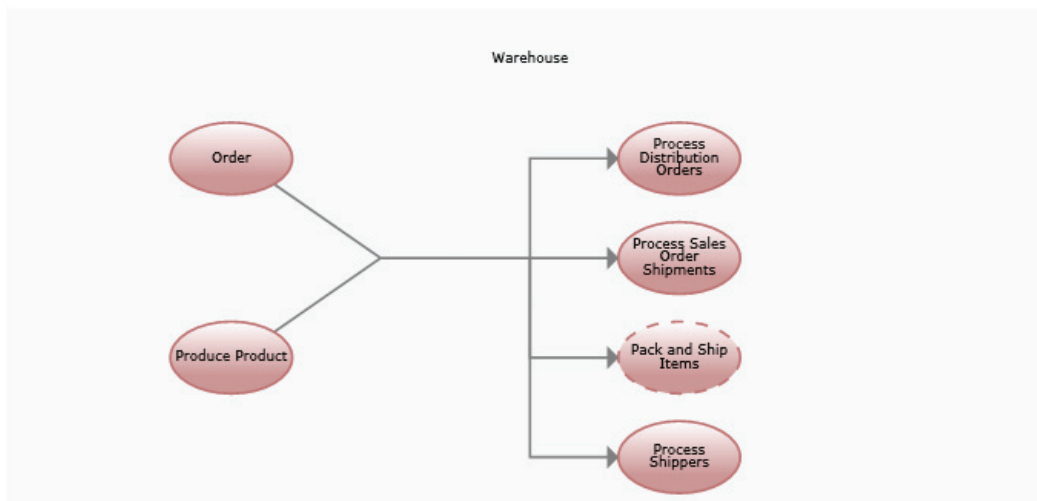

	A	B	C	D	E	F
1						
2						
3						
4						
5						
6						



Pack and Ship Items

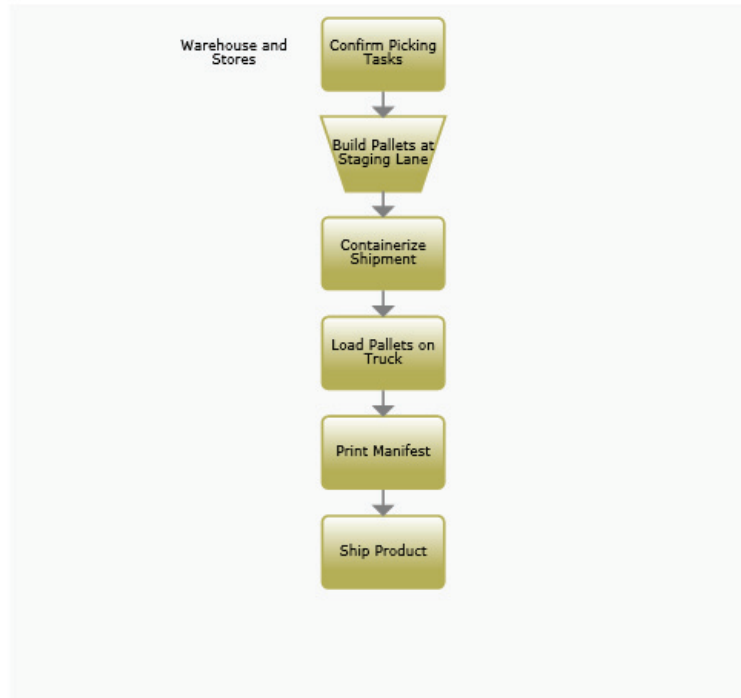

[Warehouse_6_6.xml]

	A	B	C	D	E	F
1						
2						
3						
4						
5						
6						



Process Distribution Orders

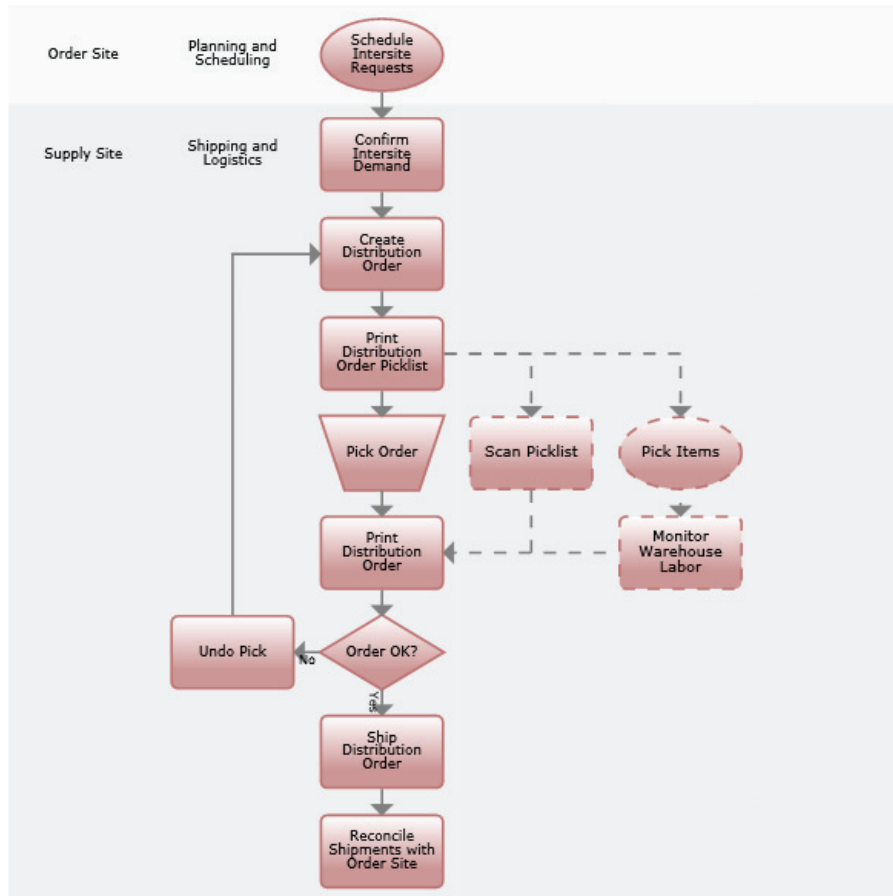

[Deliver_1_5.xml]

	A	B	C	D	E	F
1						
2						
3						
4						
5						
6						



Process Sales Order Shipments

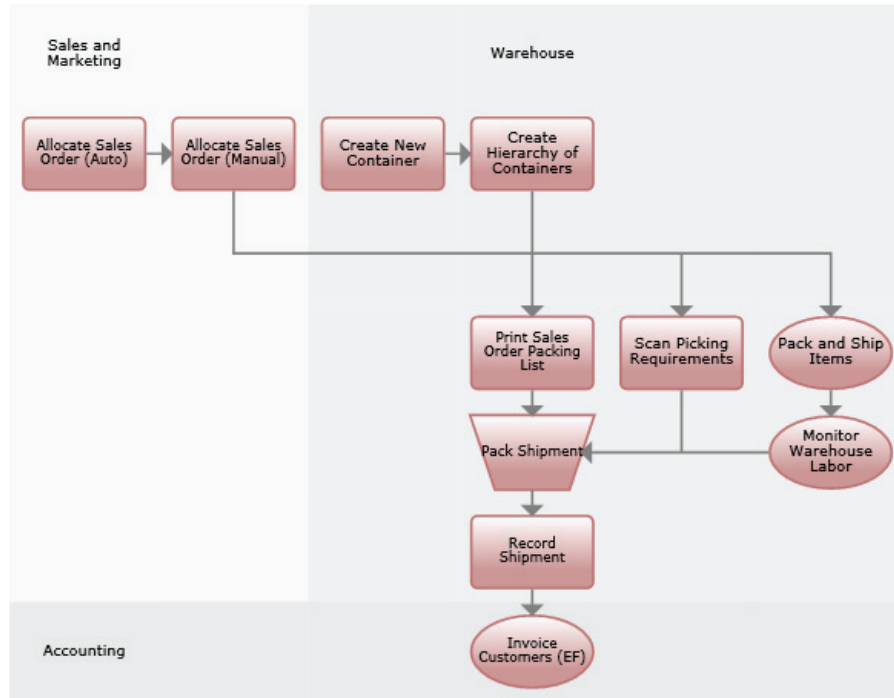

[Deliver_3_1.xml]

	A	B	C	D	E	F
1						
2						
3						
4						
5						
6						



Process Shippers

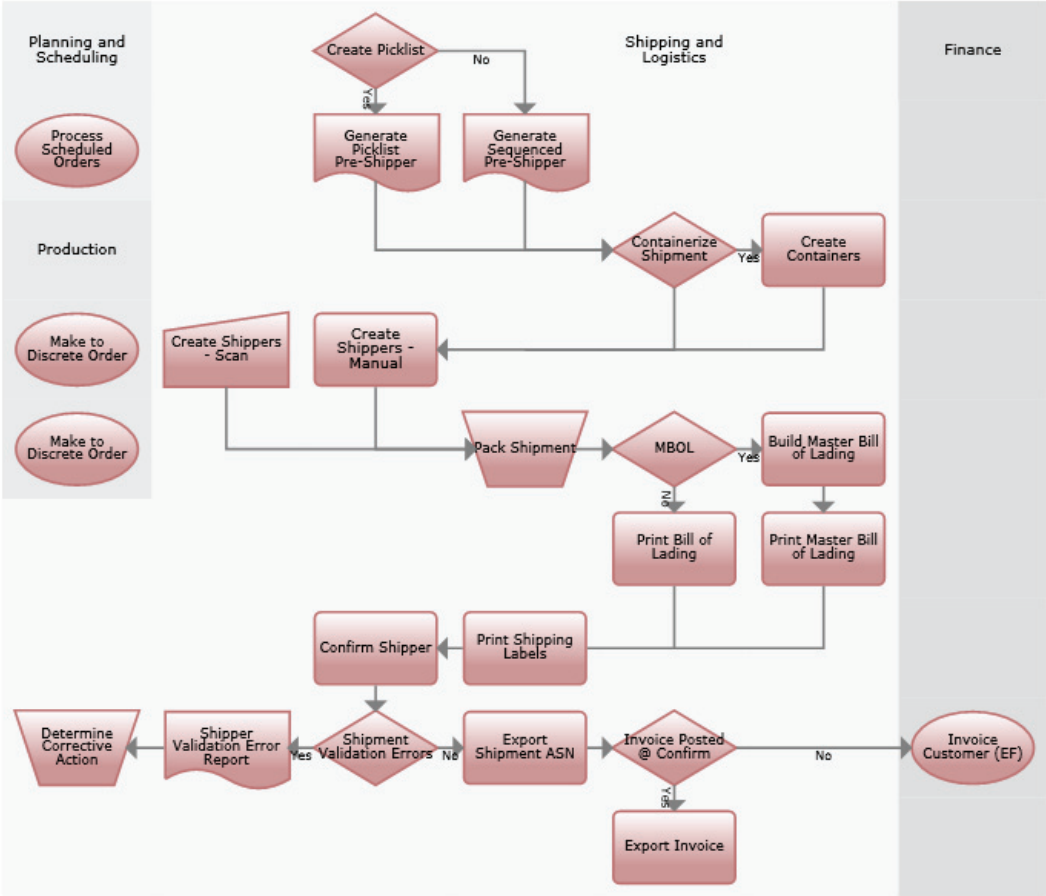

[Deliver_3_4.xml]

	A	B	C	D	E	F
1						
2						
3						
4						
5						
6						



Collect From Customer (EF)

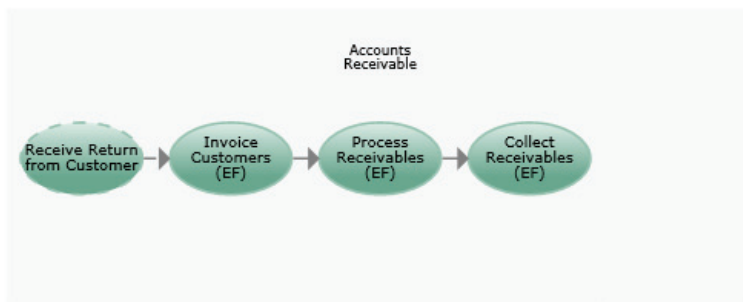

	A	B	C	D	E	F
1						
2						
3						
4						
5						
6						



Receive Return From Customer

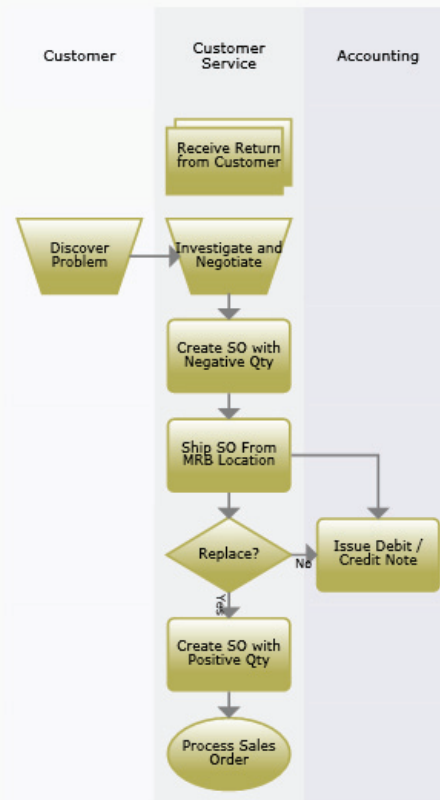

[Warehouse_3_3.xml]

	A	B	C	D	E	F
1						
2						
3						
4						
5						
6						



Invoice Customers (EF)

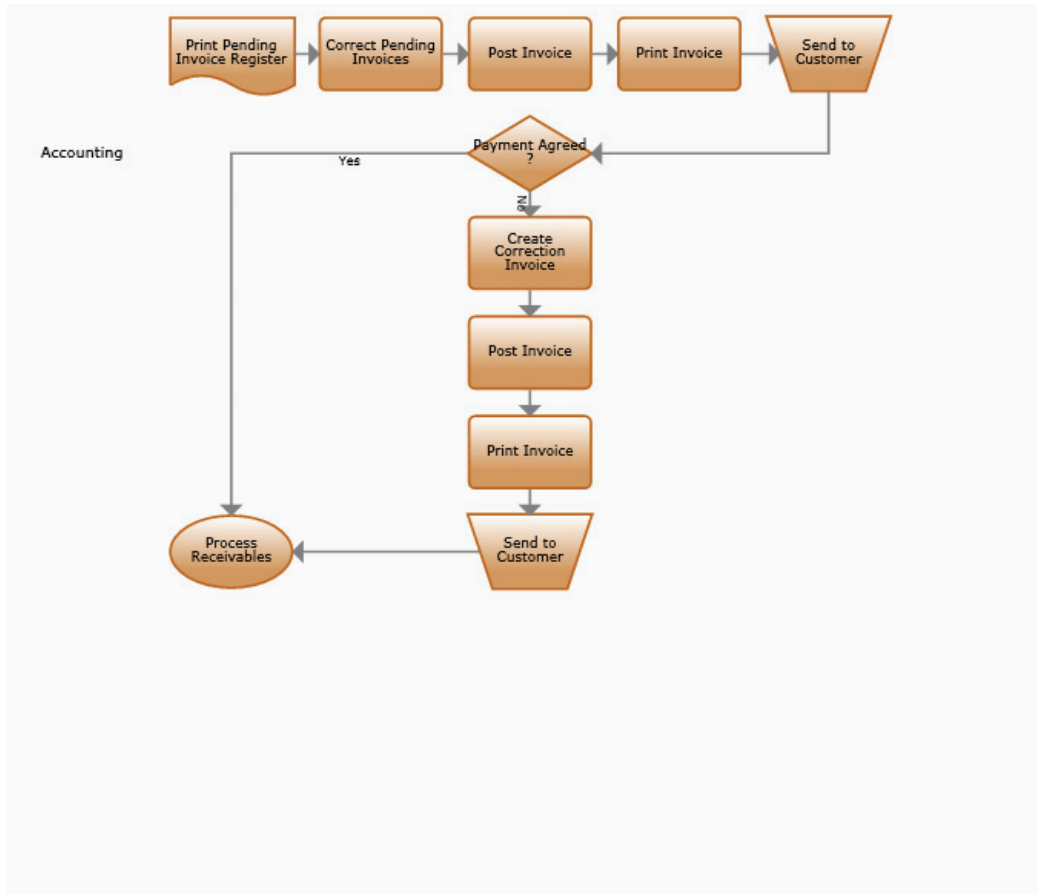

	A	B	C	D	E	F
1						
2						
3						
4						
5						
6						



Process Receivables (EF)

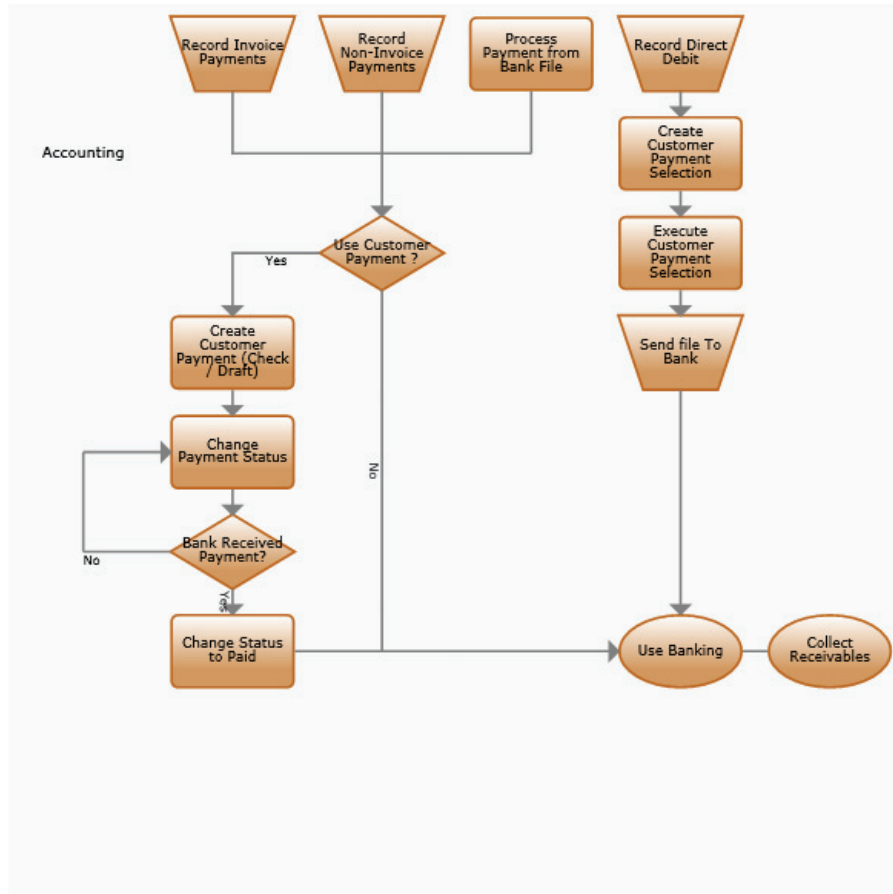

[FinanceEF_3_2.xml]

	A	B	C	D	E	F
1						
2						
3						
4						
5						
6						



Collect Receivables (EF)

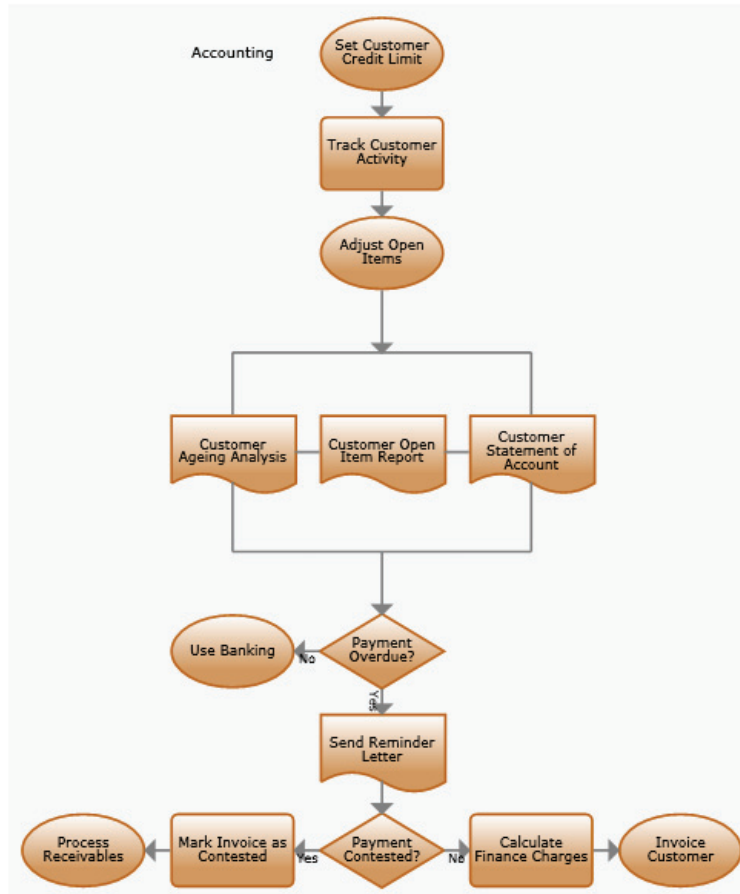

[FinanceEF_3_4.xml]

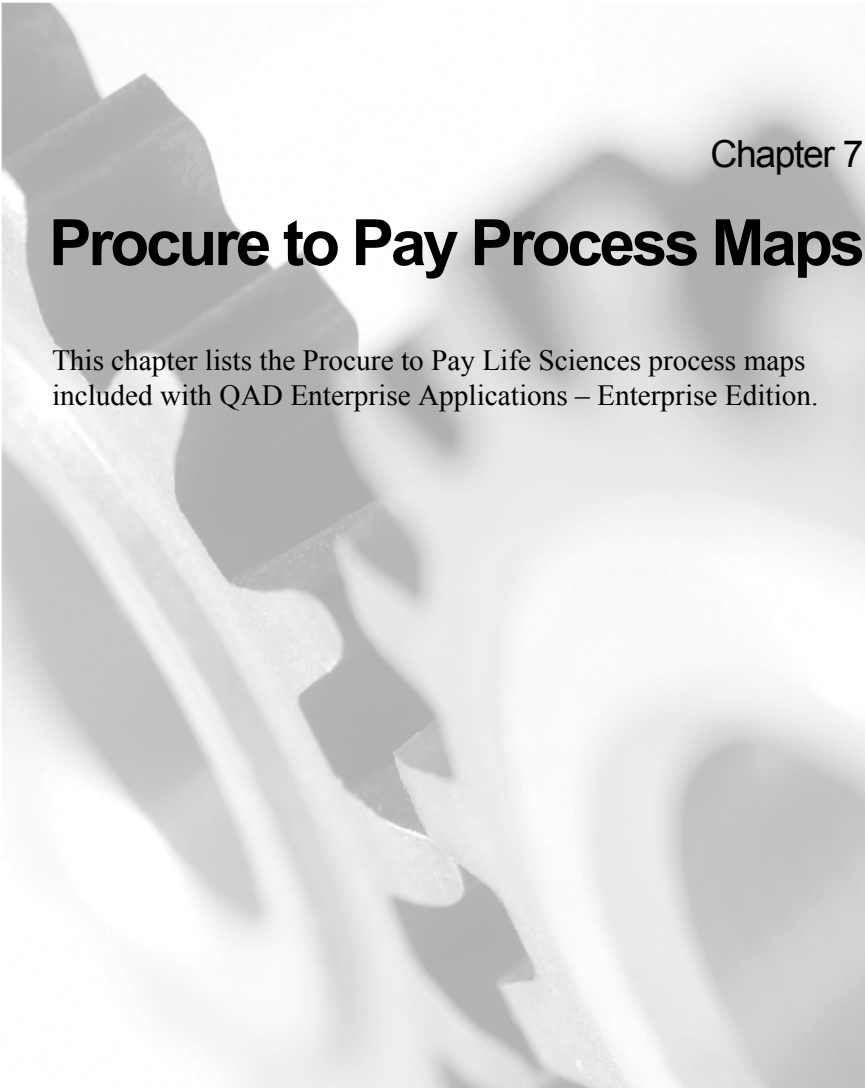

Chapter 7

Procure to Pay Process Maps

This chapter lists the Procure to Pay Life Sciences process maps included with QAD Enterprise Applications – Enterprise Edition.

Life Sciences Top Level

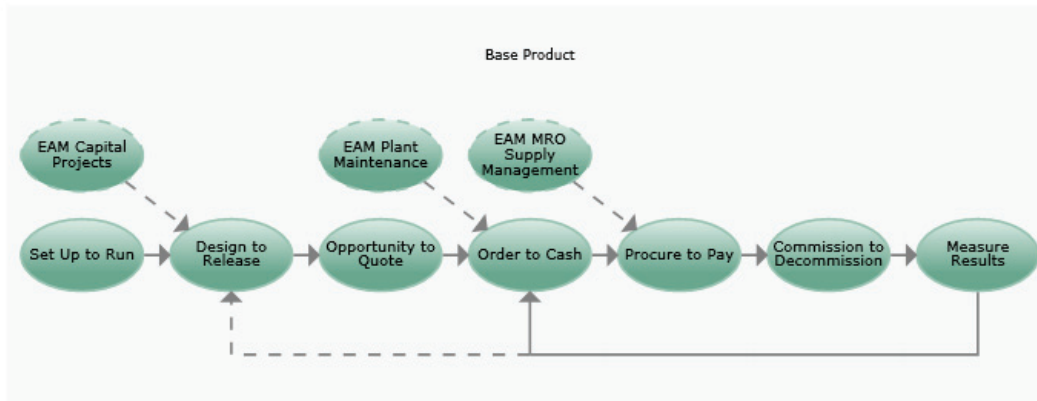

	A	B	C	D	E	F
1						
2						
3						
4						
5						
6						



Procure to Pay Top Level

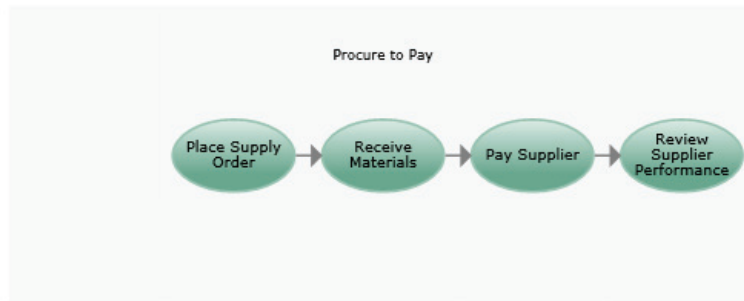

	A	B	C	D	E	F
1						
2						
3						
4						
5						
6						



Place Supply Order

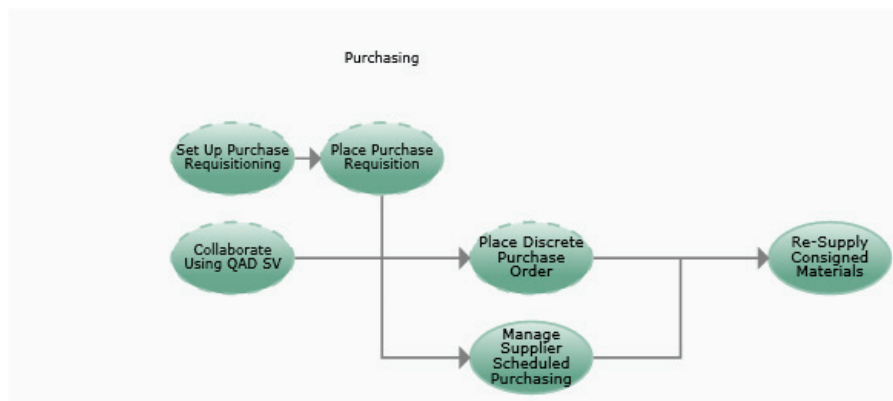

	A	B	C	D	E	F
1						
2						
3						
4						
5						
6						



Set Up Purchase Requisitioning

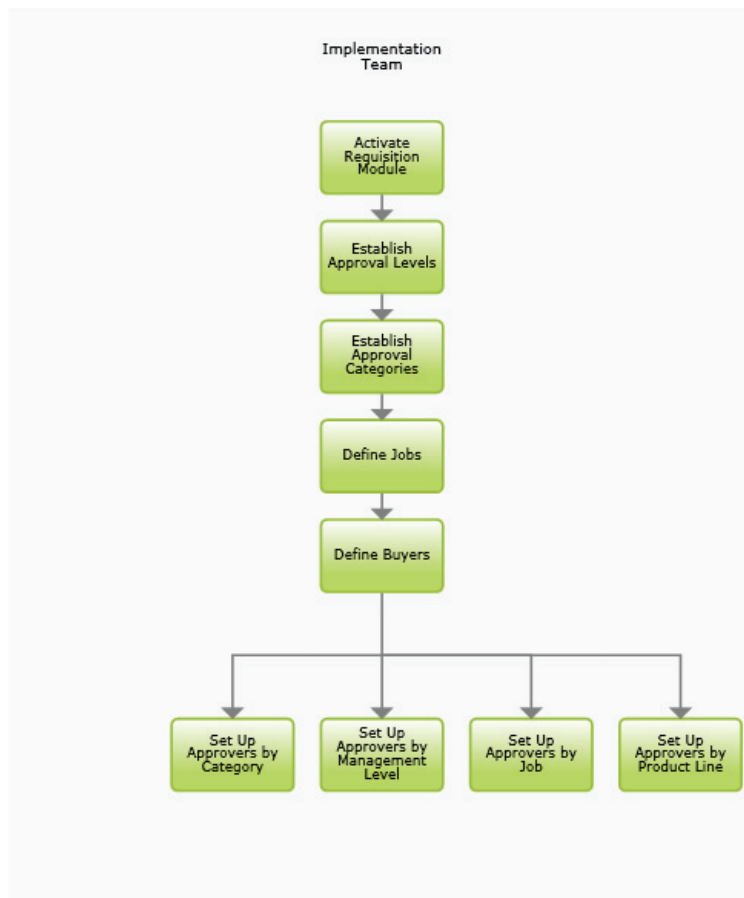

[Source_4_1.xml]

	A	B	C	D	E	F
1						
2						
3						
4						
5						
6						



Place Purchase Requisition

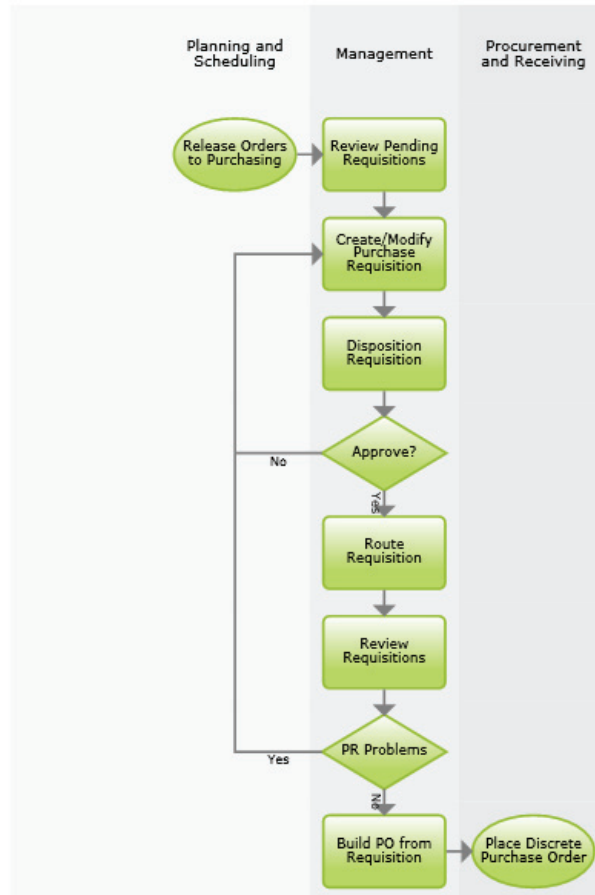

[Source_4_2.xml]

	A	B	C	D	E	F
1						
2						
3						
4						
5						
6						



Place Discrete Purchase Order

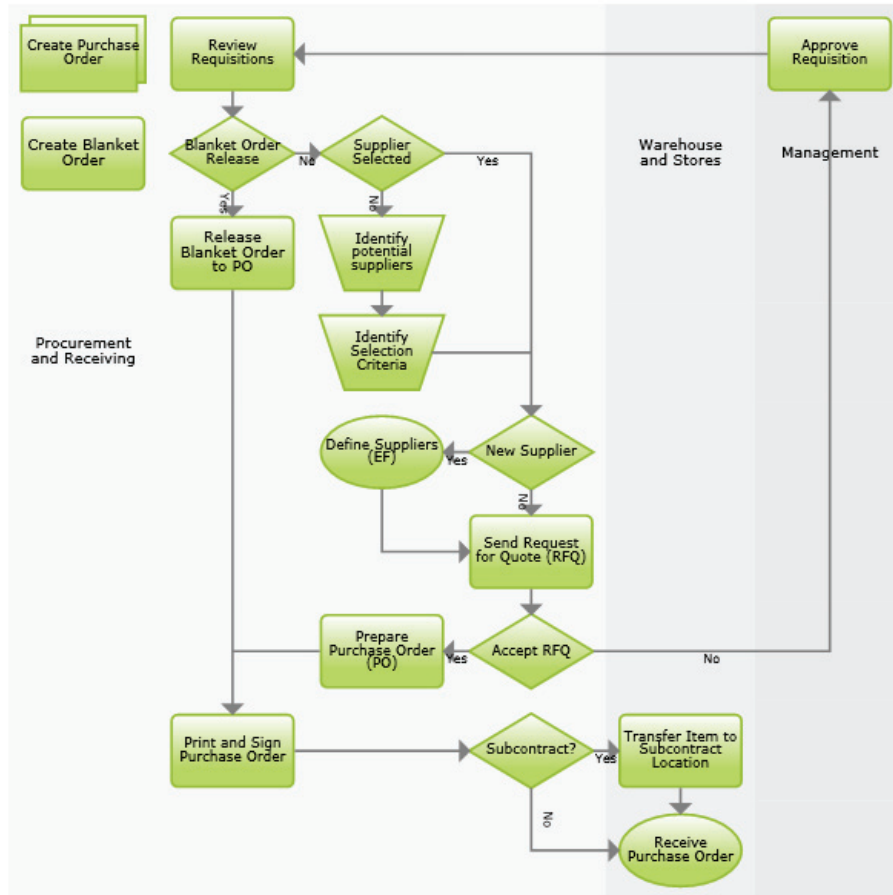

[Source_2_1.xml]

	A	B	C	D	E	F
1						
2						
3						
4						
5						
6						



Receive Materials

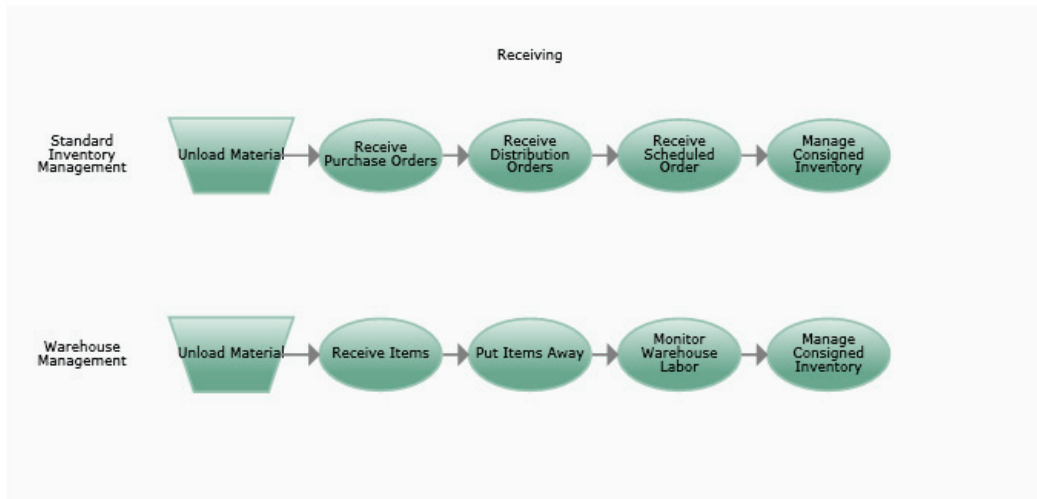

	A	B	C	D	E	F
1						
2						
3						
4						
5						
6						



Standard Inventory Management

Receive Purchase Orders

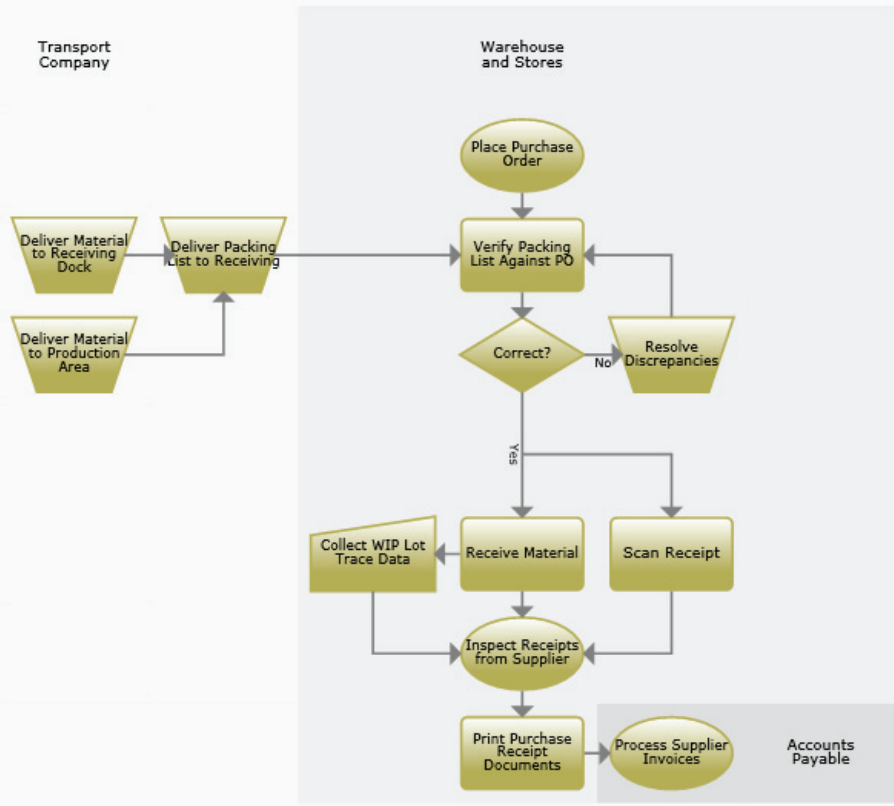

[Warehouse_1_1.xml]

	A	B	C	D	E	F
1						
2						
3						
4						
5						
6						



Inspect Receipts from Supplier

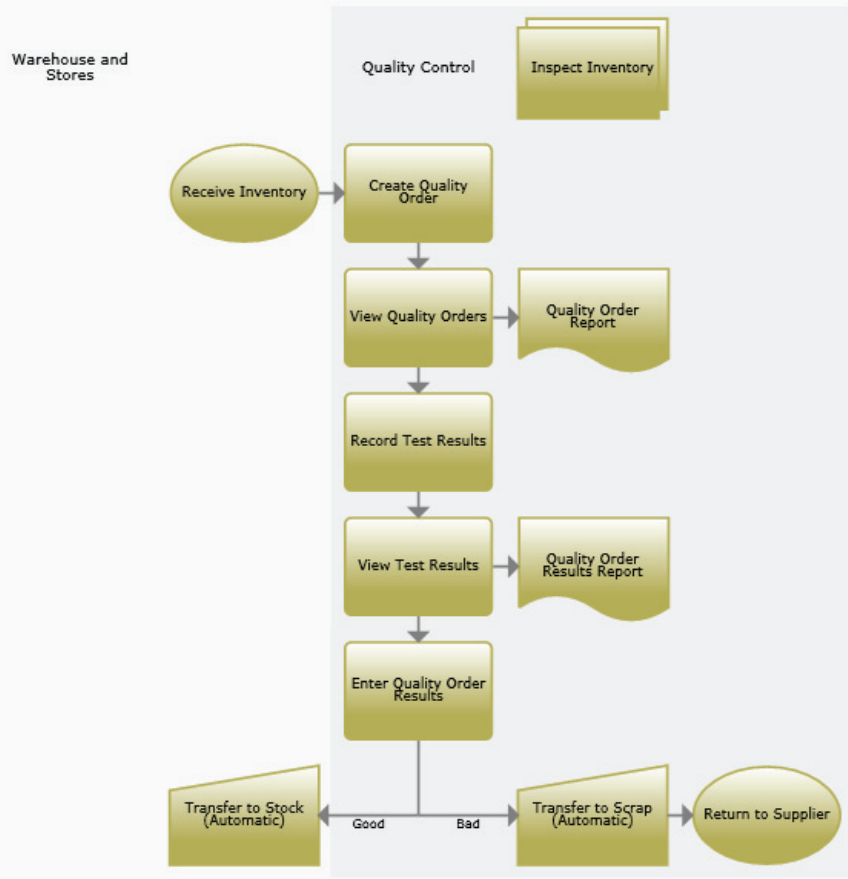

[Warehouse_4_1.xml]

	A	B	C	D	E	F
1						
2						
3						
4						
5						
6						



Return to Supplier

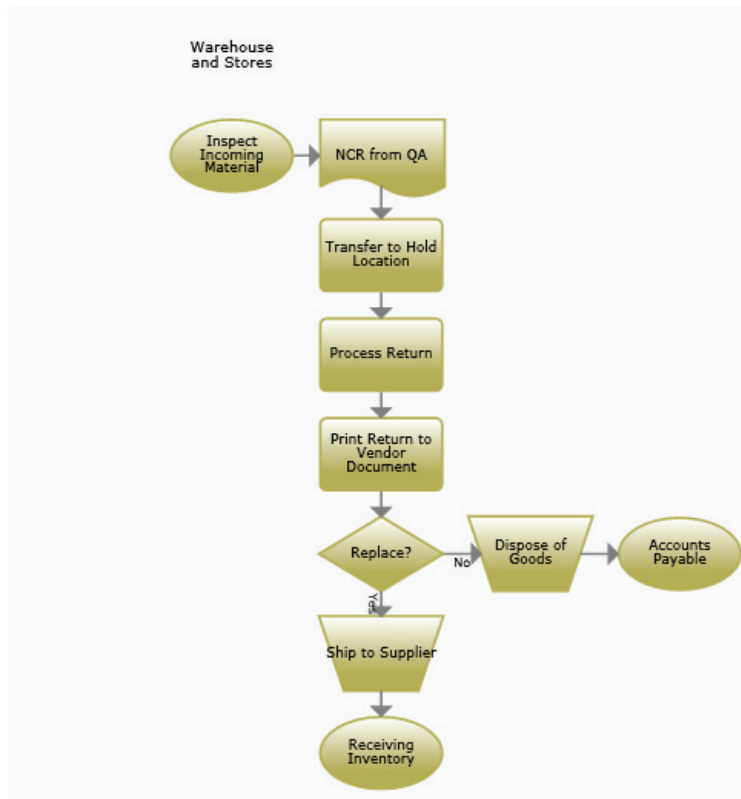

[Warehouse_3_1.xml]

	A	B	C	D	E	F
1						
2						
3						
4						
5						
6						



Receive Distribution Orders

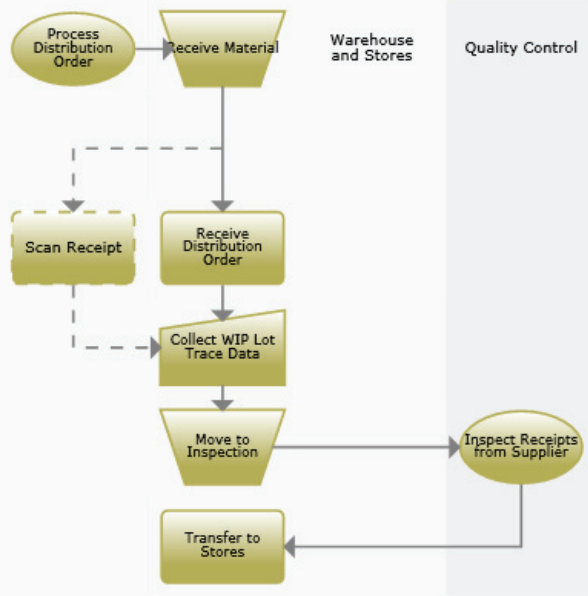

[Warehouse_1_8.xml]

	A	B	C	D	E	F
1						
2						
3						
4						
5						
6						



Advanced Inventory Management Receive Items

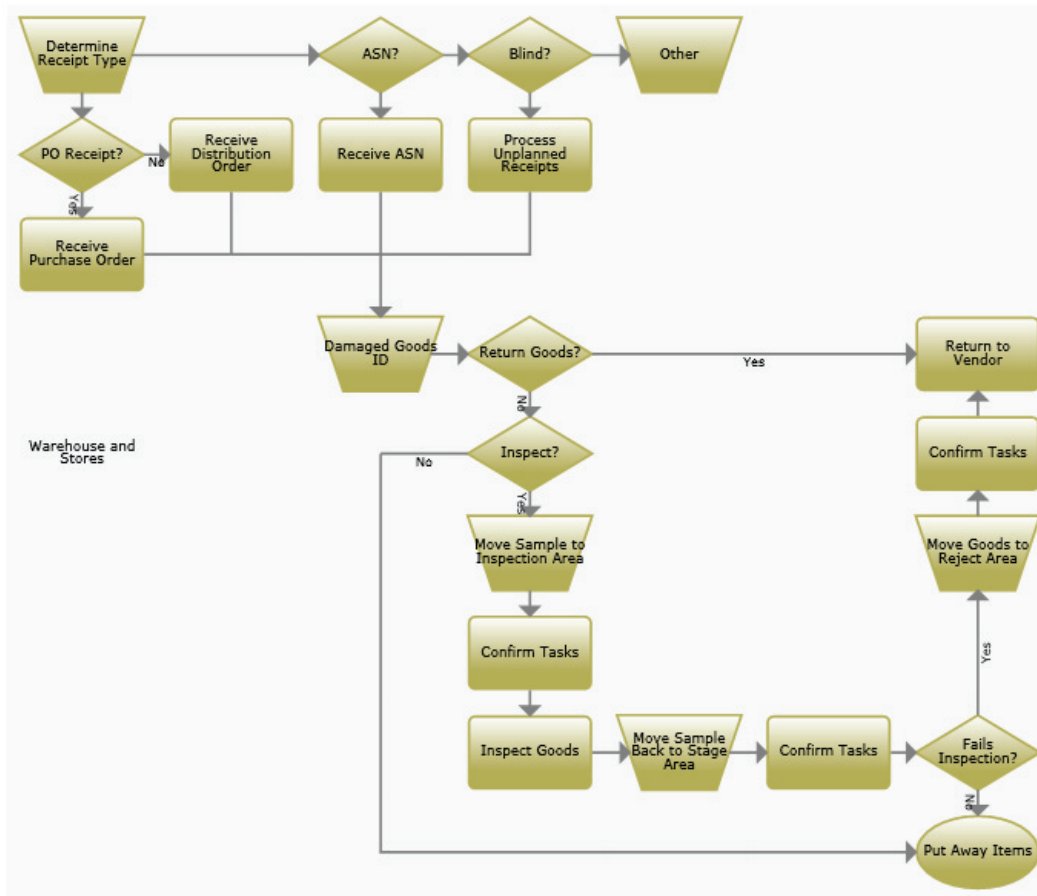

[Warehouse_6_2.xml]

	A	B	C	D	E	F
1						
2						
3						
4						
5						
6						



Put Items Away

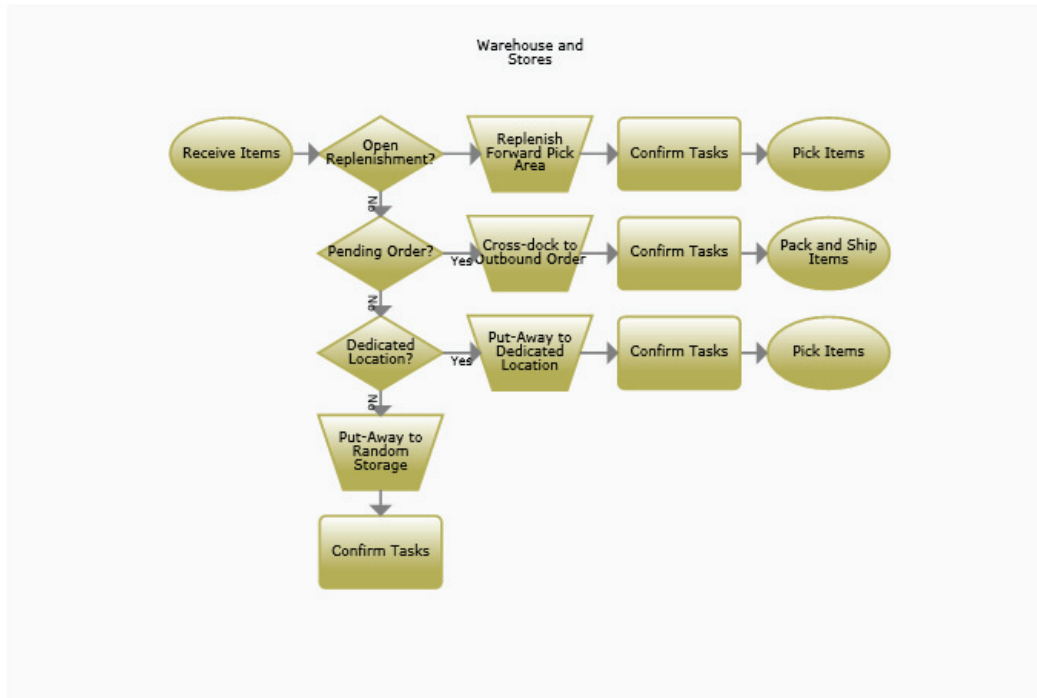

[Warehouse_6_3.xml]

	A	B	C	D	E	F
1						
2						
3						
4						
5						
6						



Monitor Warehouse Labor

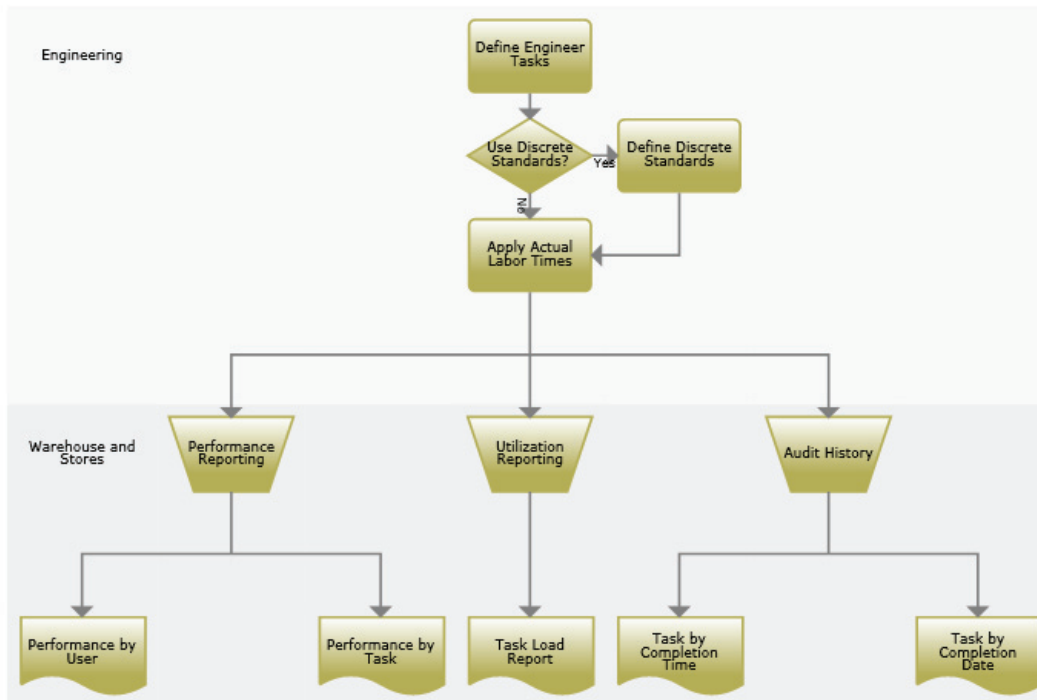

[Warehouse_6_7.xml]

	A	B	C	D	E	F
1						
2						
3						
4						
5						
6						



Pay Supplier

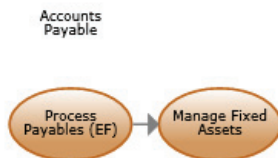

	A	B	C	D	E	F
1						
2						
3						
4						
5						
6						



Process Vouchers (EF)

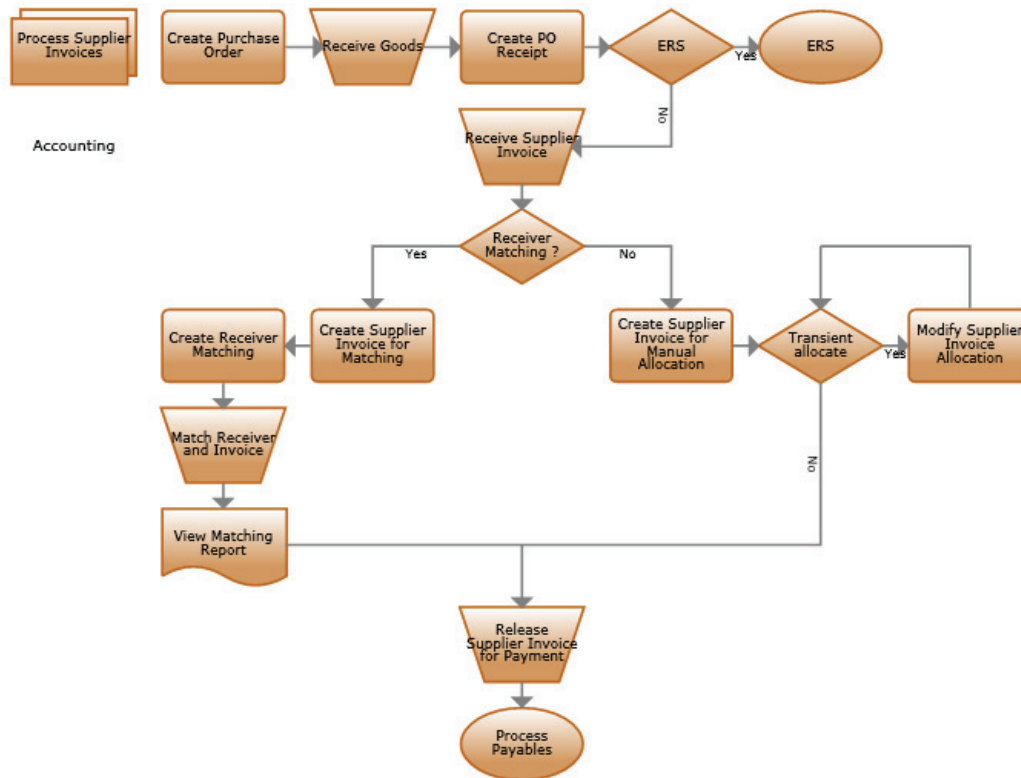

	A	B	C	D	E	F
1						
2						
3						
4						
5						
6						



ERS Processing

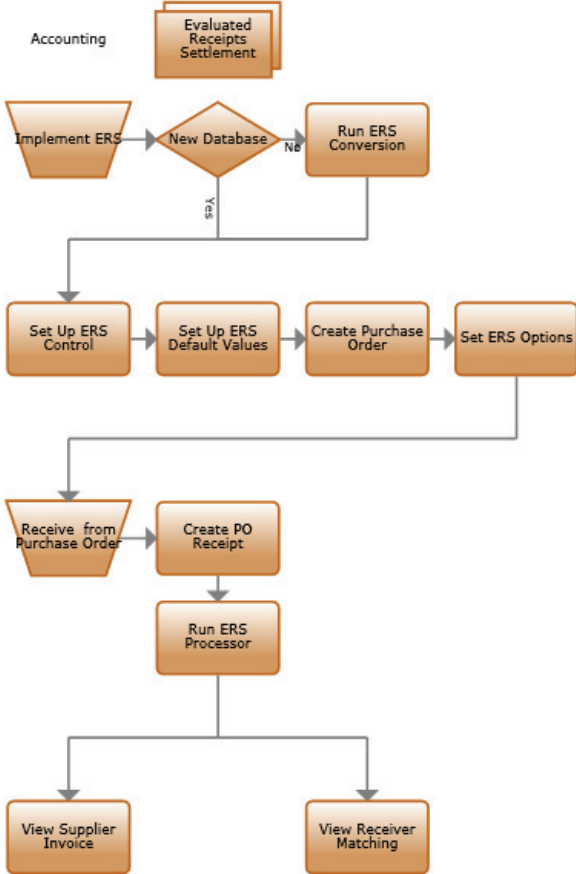

	A	B	C	D	E	F
1						
2						
3						
4						
5						
6						



Manage Fixed Assets

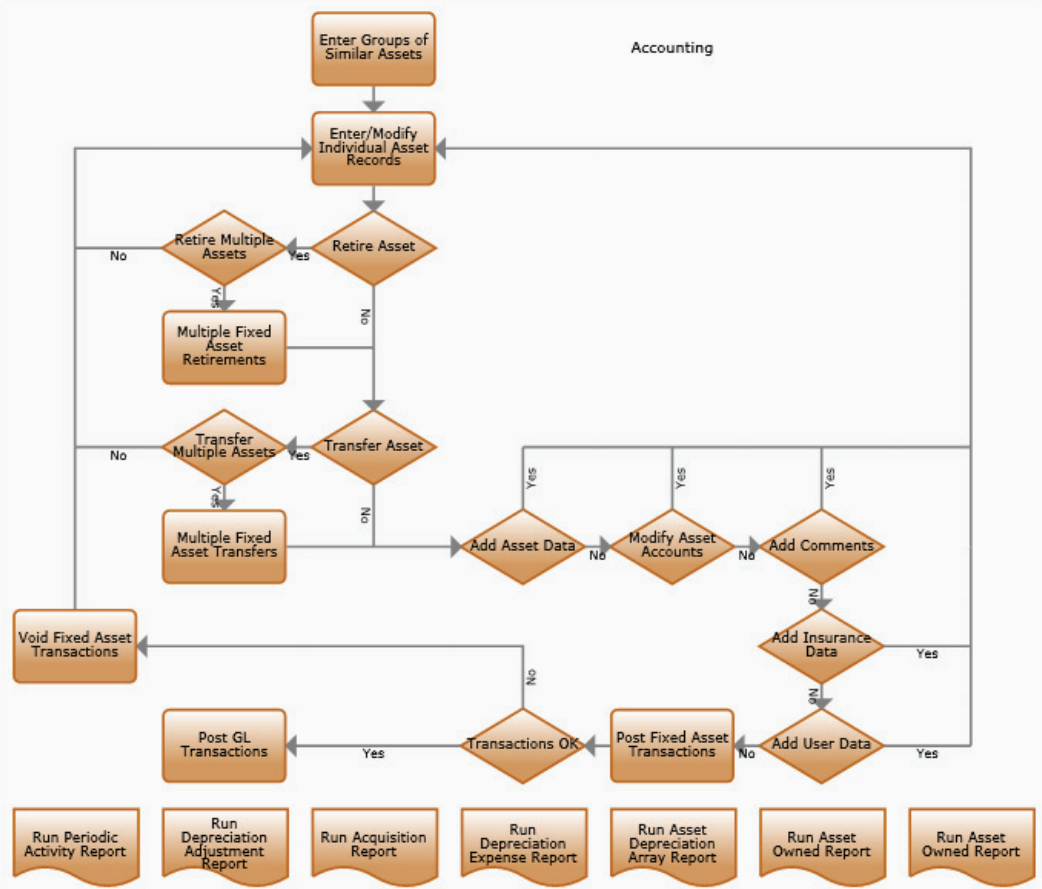

[Finance_7_2.xml]

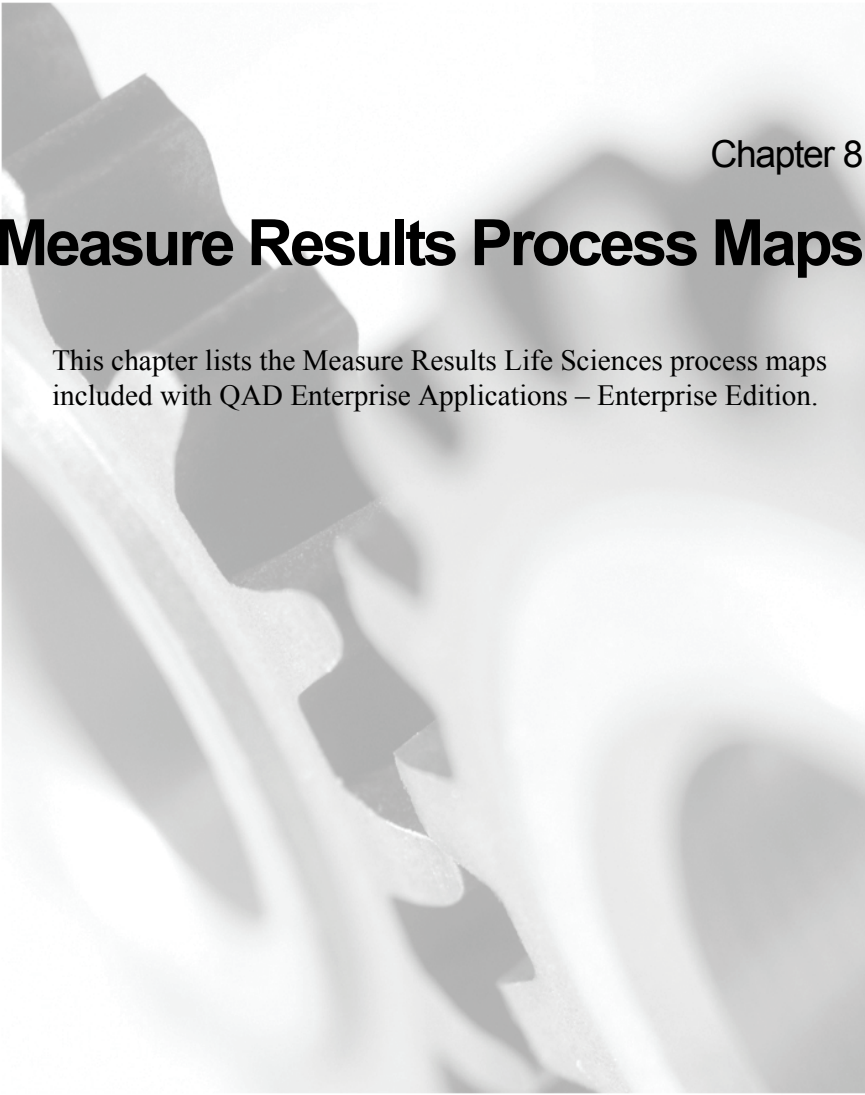

Chapter 8

Measure Results Process Maps

This chapter lists the Measure Results Life Sciences process maps included with QAD Enterprise Applications – Enterprise Edition.

Life Sciences Top Level

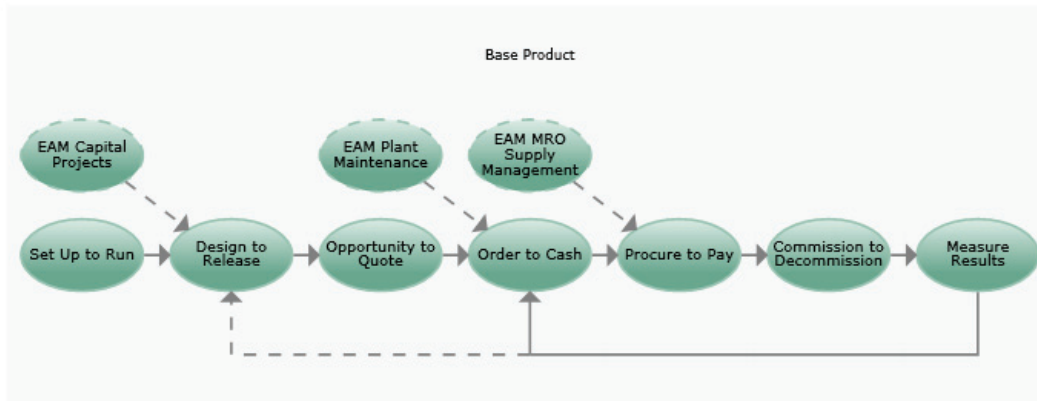

	A	B	C	D	E	F
1						
2						
3						
4						
5						
6						



Measure Results Top Level

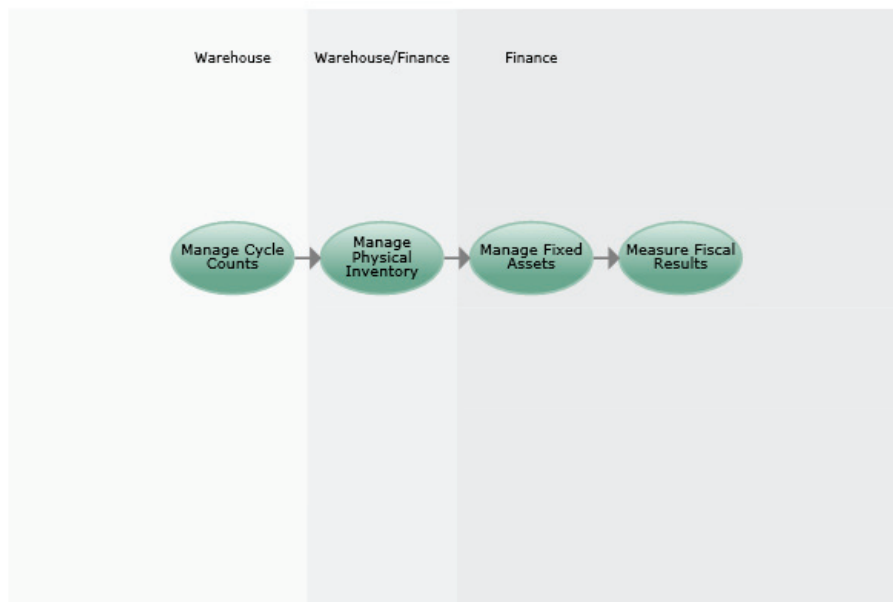

	A	B	C	D	E	F
1						
2						
3						
4						
5						
6						



Manage Cycle Counts

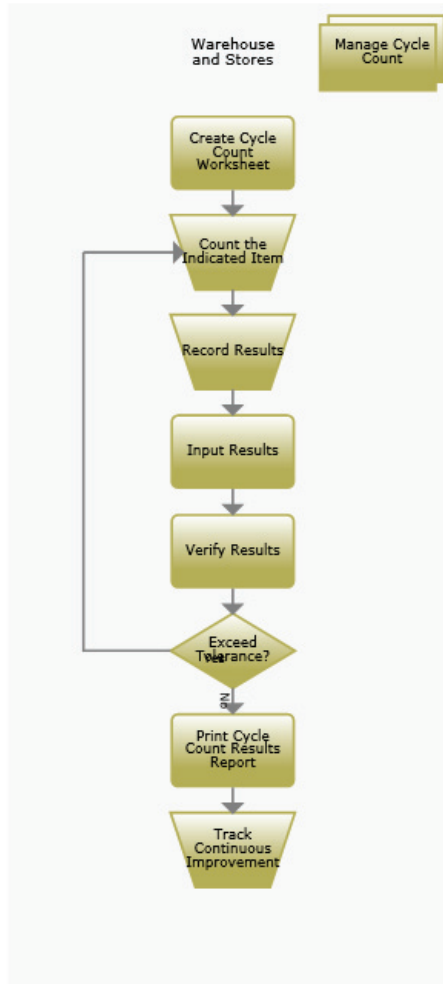

[Warehouse_5_1.xml]

	A	B	C	D	E	F
1						
2						
3						
4						
5						
6						



Manage Physical Inventory

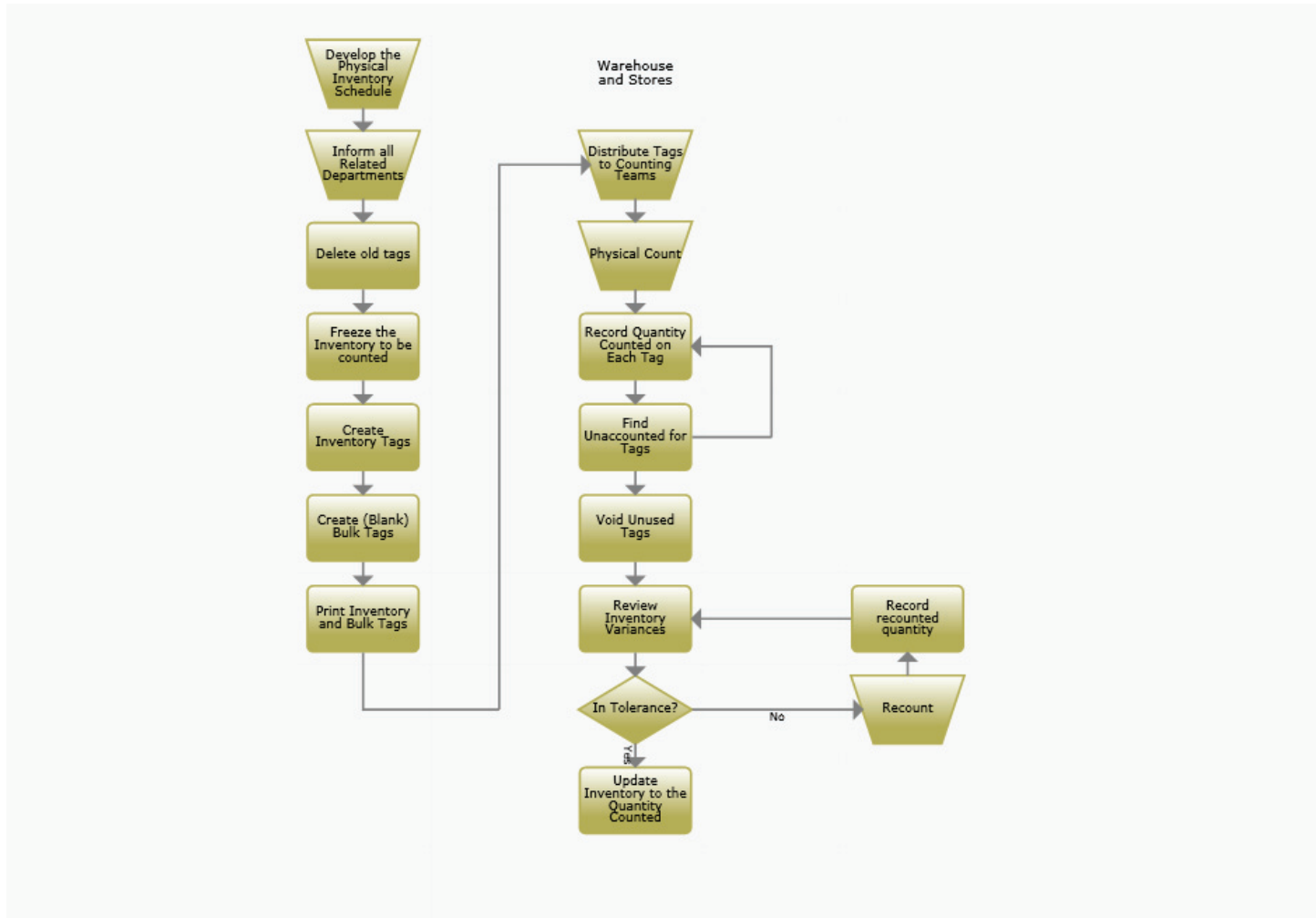

[Warehouse_5_2.xml]

	A	B	C	D	E	F
1						
2						
3						
4						
5						
6						



Manage Fixed Assets

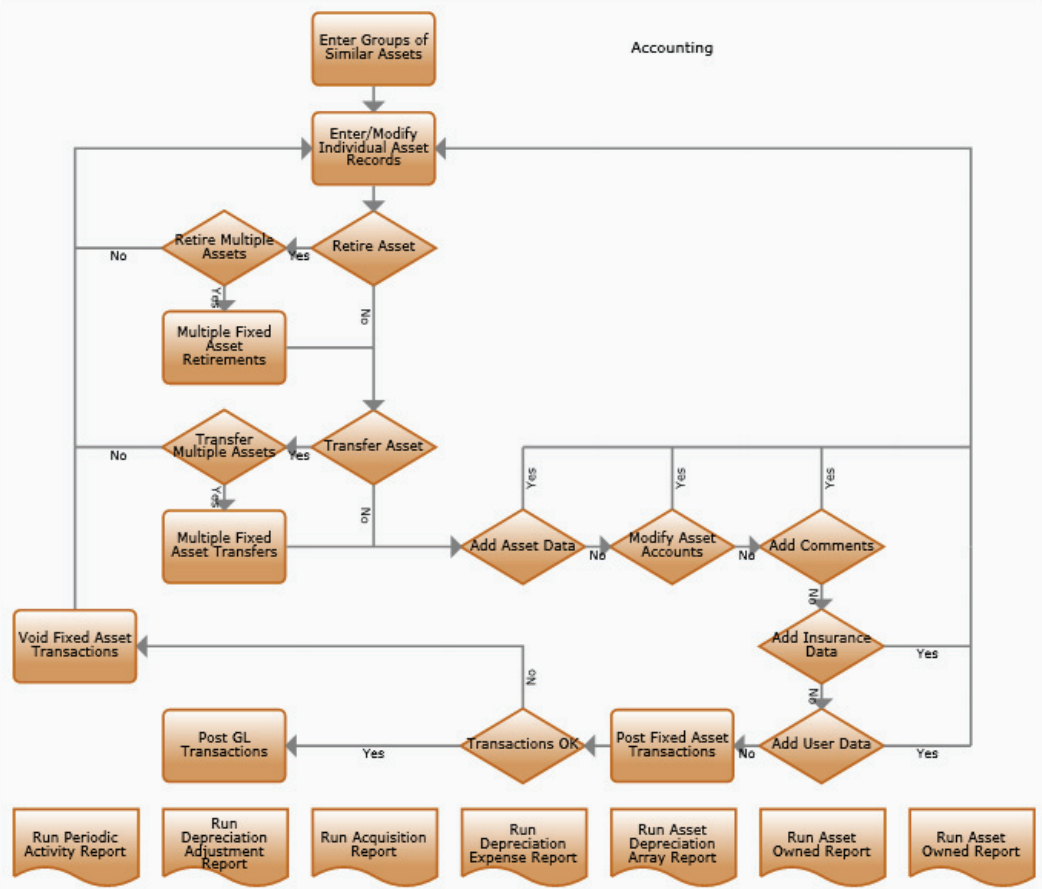

[Finance_7_2.xml]

	A	B	C	D	E	F
1						
2						
3						
4						
5						
6						



Use Enterprise Financials

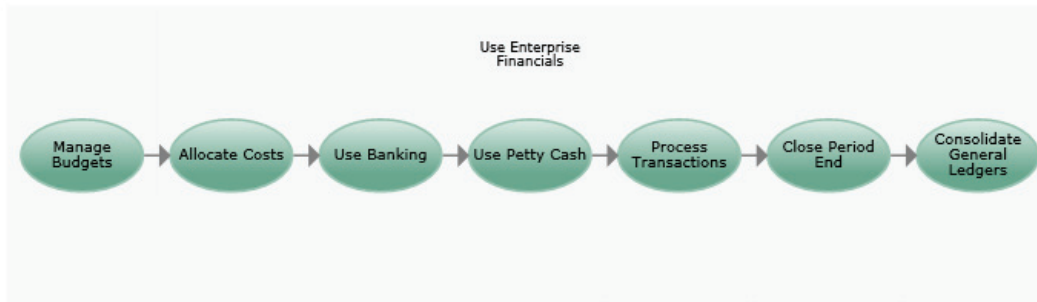

	A	B	C	D	E	F
1						
2						
3						
4						
5						
6						



Manage Budgets

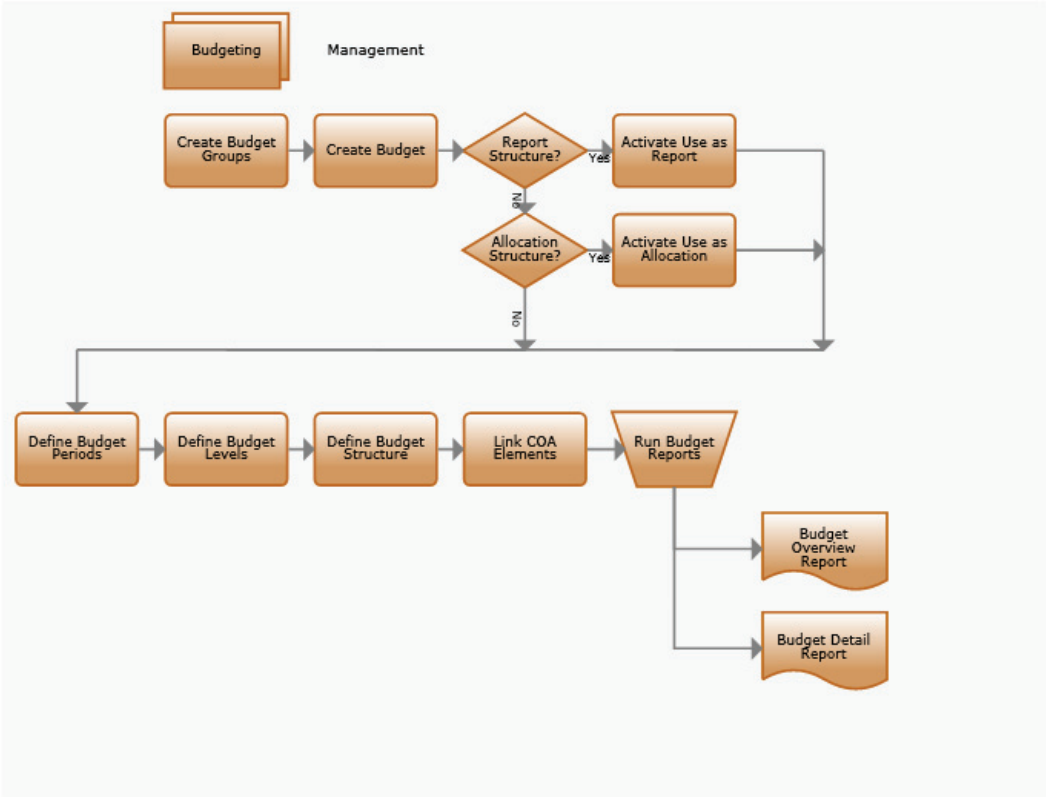

	A	B	C	D	E	F
1						
2						
3						
4						
5						
6						



Allocate Costs

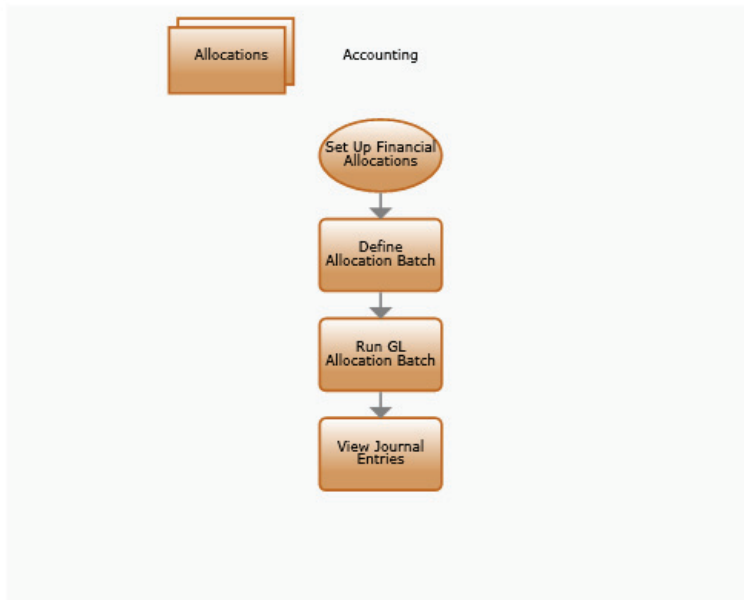

[FinanceEF_1_1.xml]

	A	B	C	D	E	F
1						
2						
3						
4						
5						
6						



Use Banking

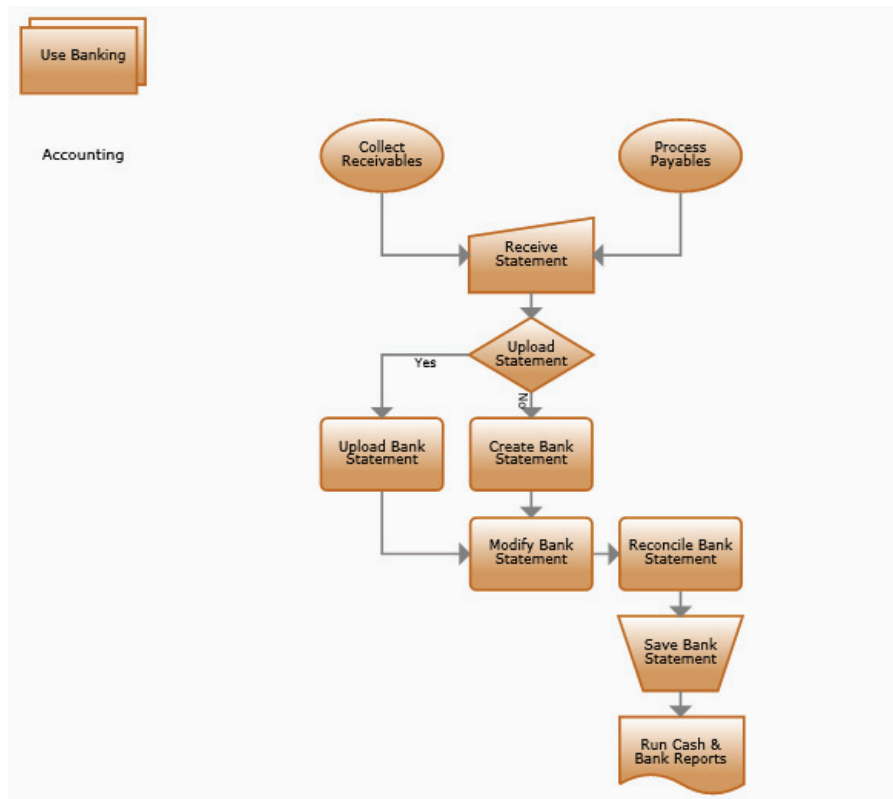

[FinanceEF_6_1.xml]

	A	B	C	D	E	F
1						
2						
3						
4						
5						
6						



Use Petty Cash

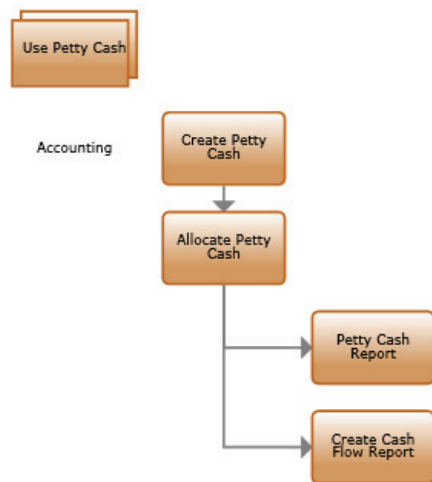

	A	B	C	D	E	F
1						
2						
3						
4						
5						
6						



Process Transactions



	A	B	C	D	E	F
1						
2						
3						
4						
5						
6						



Post Journal Entries

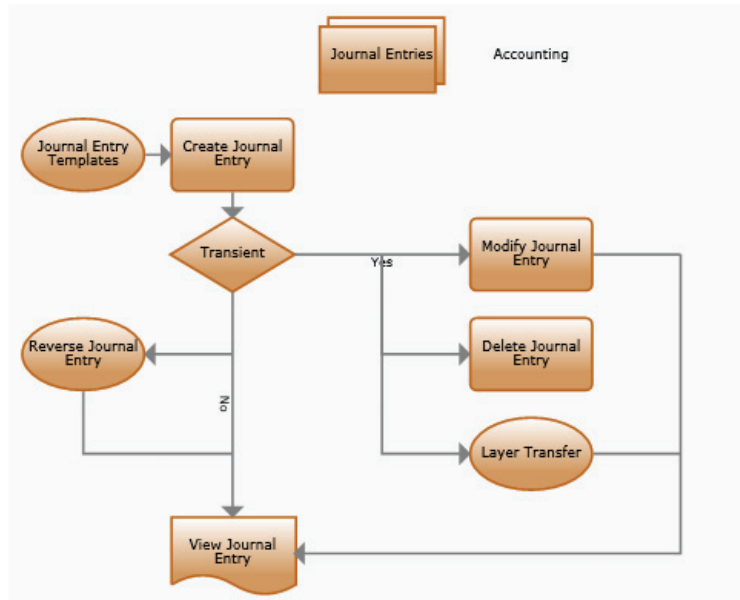

[FinanceEF_1_3_1.xml]

	A	B	C	D	E	F
1						
2						
3						
4						
5						
6						



Post Recurring Entries

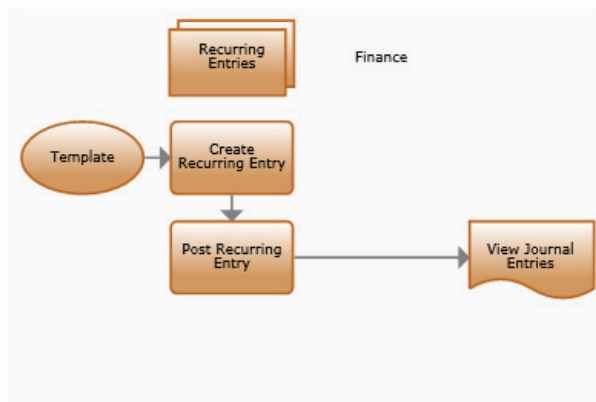

[FinanceEF_1_3_2.xml]

	A	B	C	D	E	F
1						
2						
3						
4						
5						
6						



Intercompany Transactions

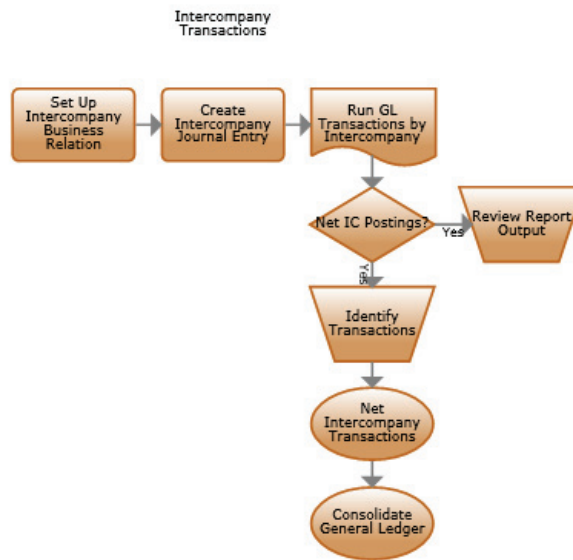

	A	B	C	D	E	F
1						
2						
3						
4						
5						
6						



Revaluation



[FinanceEF_1_3_6.xml]

	A	B	C	D	E	F
1						
2						
3						
4						
5						
6						



Set Up Revaluation

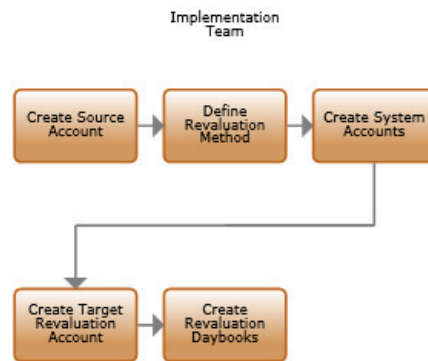

[FinanceEF_1_3_6_1.xml]

	A	B	C	D	E	F
1						
2						
3						
4						
5						
6						



Reverse Journal Entries

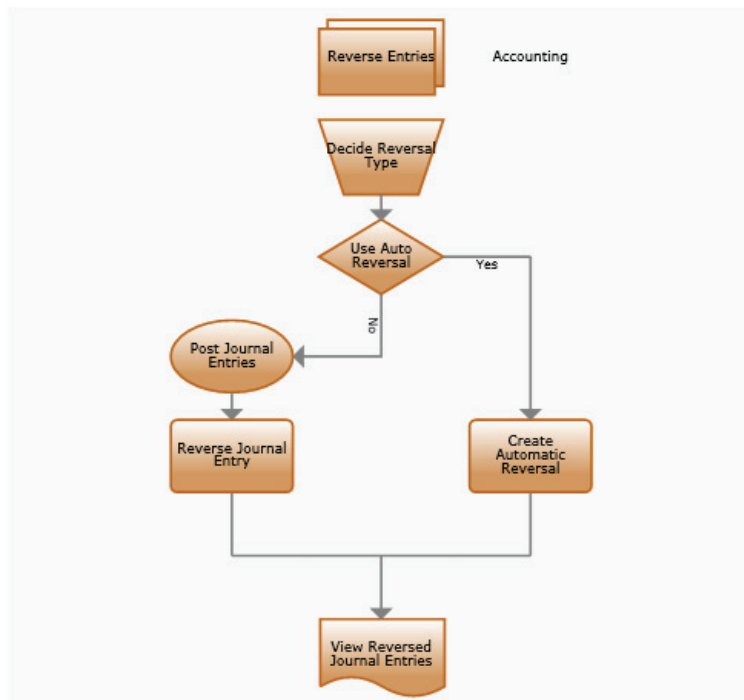

[FinanceEF_1_3_3.xml]

	A	B	C	D	E	F
1						
2						
3						
4						
5						
6						



Cross-Company Transactions

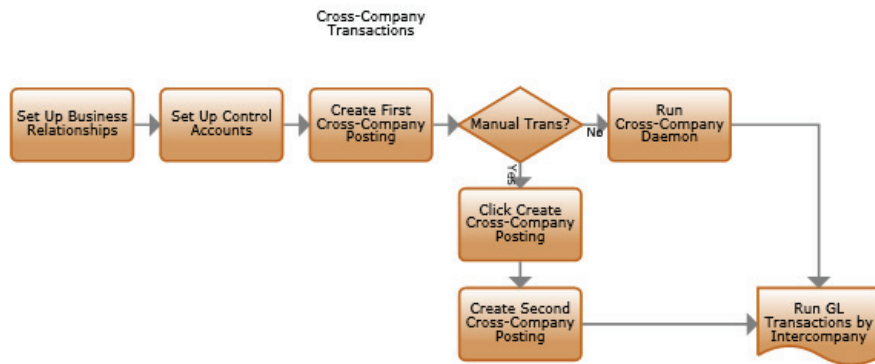

	A	B	C	D	E	F
1						
2						
3						
4						
5						
6						



Open Item Adjustment

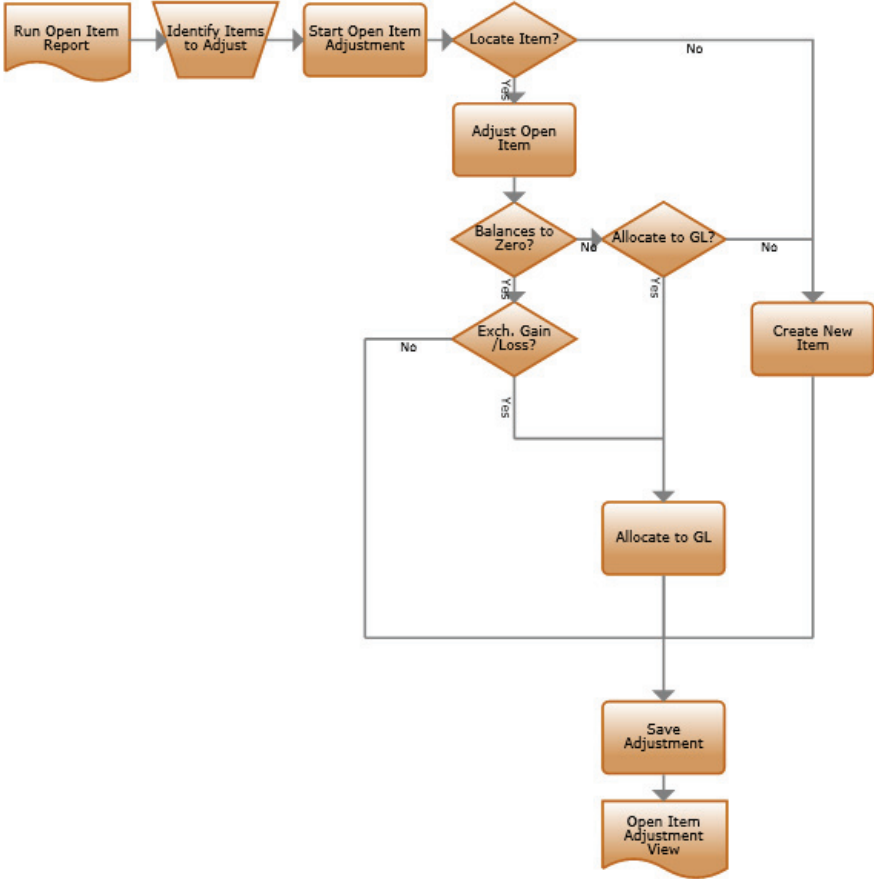

	A	B	C	D	E	F
1						
2						
3						
4						
5						
6						



Run Allocations

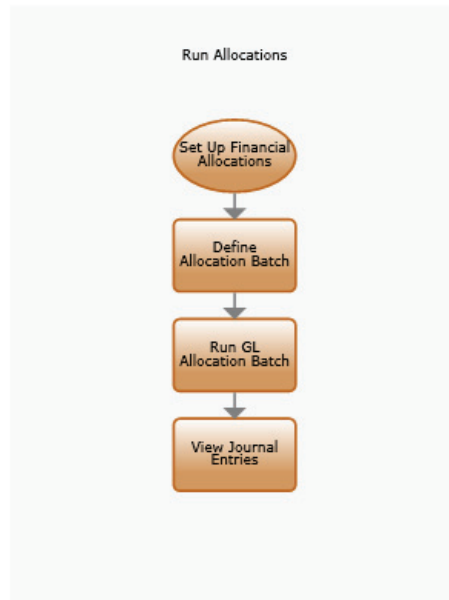

[FinanceEF_1_3_12.xml]

	A	B	C	D	E	F
1						
2						
3						
4						
5						
6						



Mirror Accounting



	A	B	C	D	E	F
1						
2						
3						
4						
5						
6						



Set Up Mirror Accounting

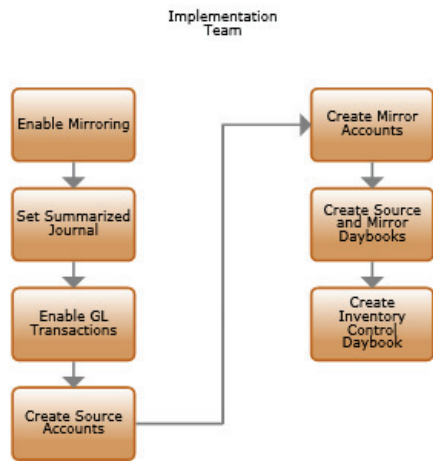

	A	B	C	D	E	F
1						
2						
3						
4						
5						
6						



Create Templates

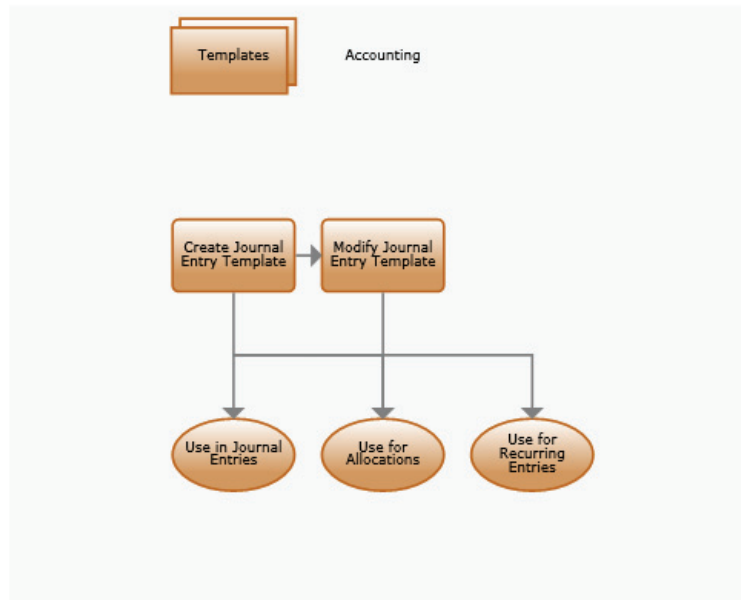

[FinanceEF_1_3_5.xml]

	A	B	C	D	E	F
1						
2						
3						
4						
5						
6						



Layer Transfer

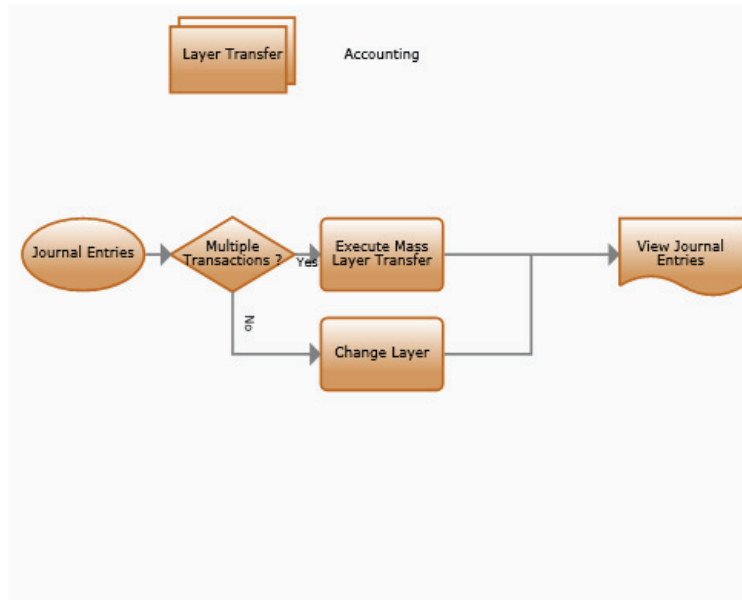

[FinanceEF_1_3_4.xml]

	A	B	C	D	E	F
1						
2						
3						
4						
5						
6						



Year-End Closing

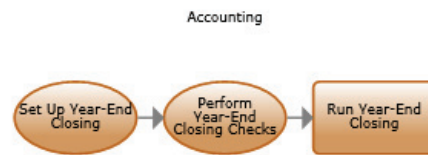

[FinanceEF_1_3_11.xml]

	A	B	C	D	E	F
1						
2						
3						
4						
5						
6						



Set Up Year-End Closing

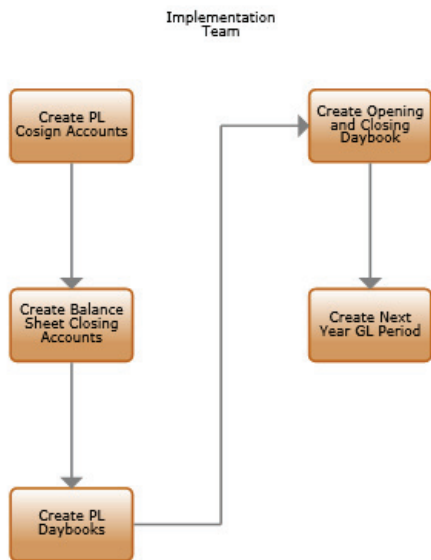

[FinanceEF_1_3_11_1.xml]

	A	B	C	D	E	F
1						
2						
3						
4						
5						
6						



Perform Year-End Closing Checks

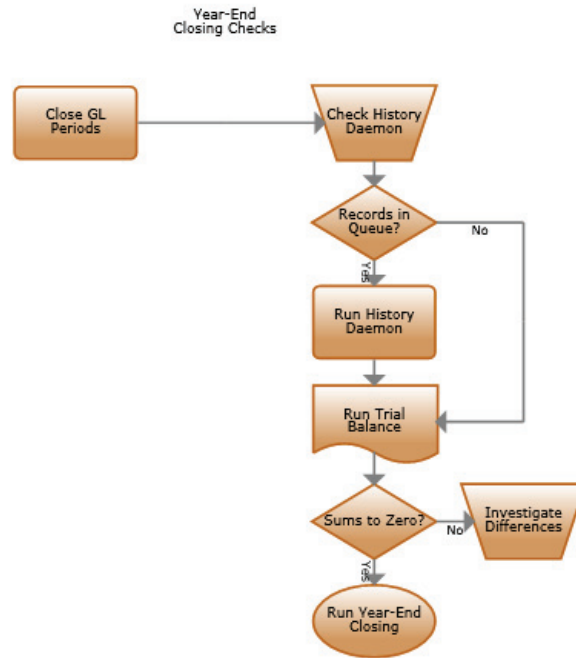

	A	B	C	D	E	F
1						
2						
3						
4						
5						
6						



Close Period End

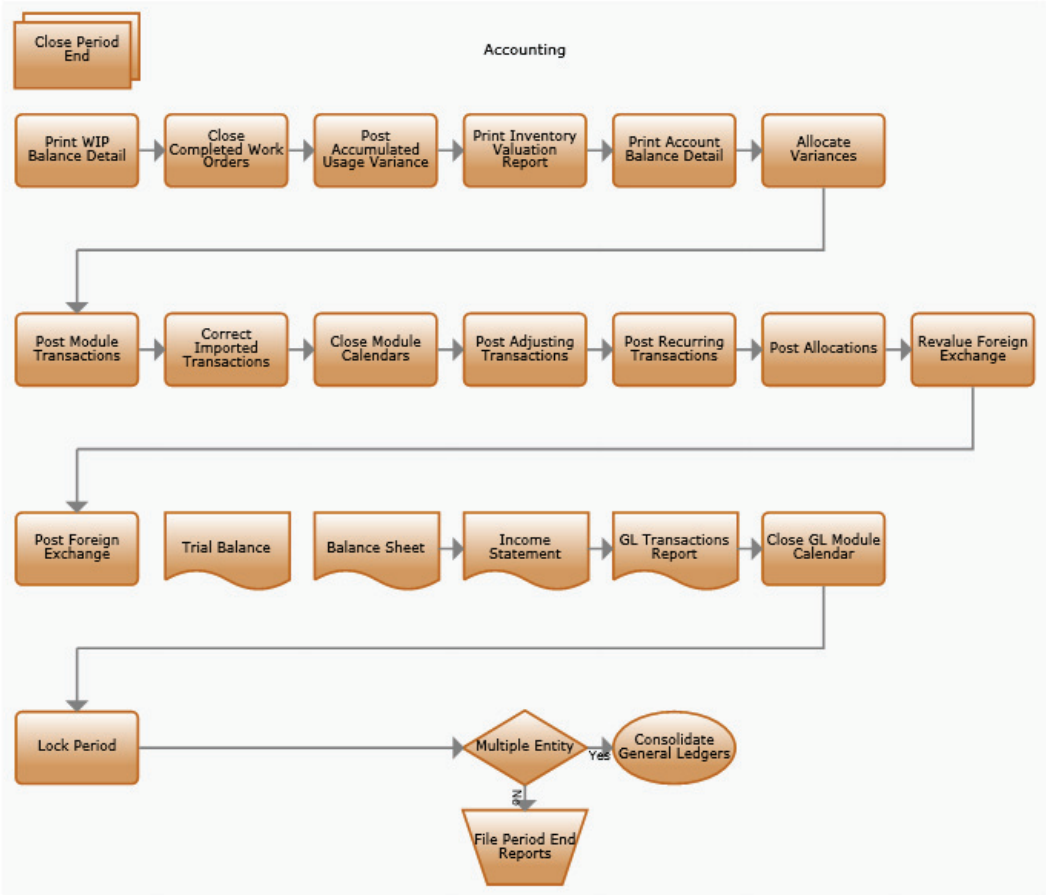

[FinanceEF_1_4.xml]

	A	B	C	D	E	F
1						
2						
3						
4						
5						
6						



Consolidate General Ledgers

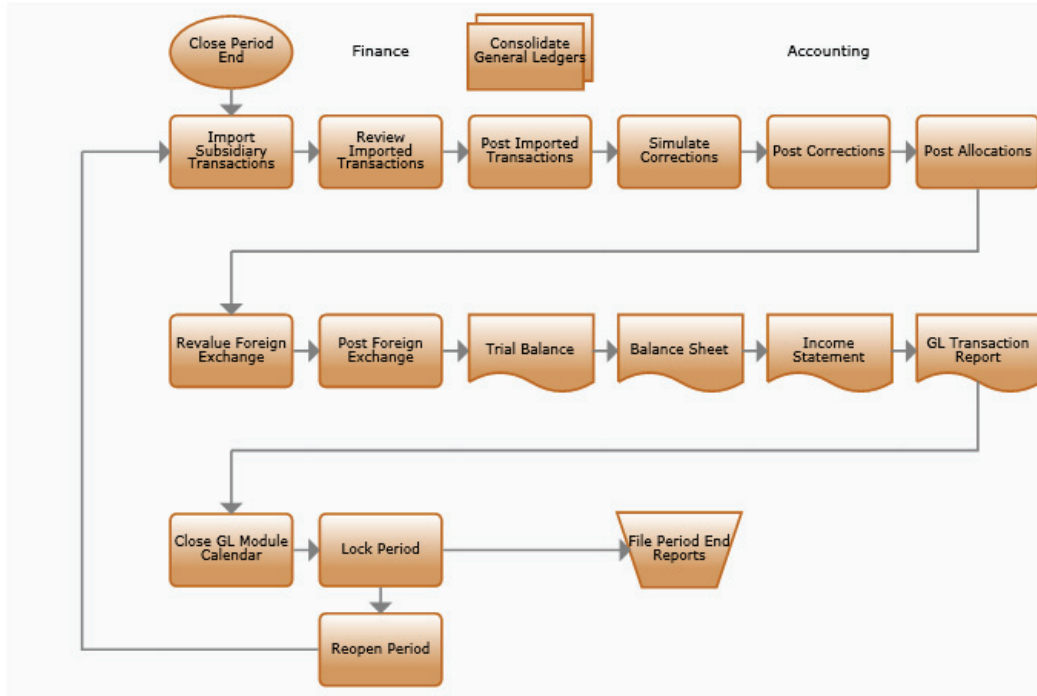

[FinanceEF_1_5.xml]