



QAD Enterprise Applications
Enterprise Edition

User Guide
QAD Automation Solutions:
Data Collection Transactions

70-3394-2018EE
Data Collection Transactions 2018EE
QAD Enterprise Applications Enterprise Edition
March 2019

This document contains proprietary information that is protected by copyright and other intellectual property laws. No part of this document may be reproduced, translated, or modified without the prior written consent of QAD Inc. The information contained in this document is subject to change without notice.

QAD Inc. provides this material as is and makes no warranty of any kind, expressed or implied, including, but not limited to, the implied warranties of merchantability and fitness for a particular purpose. QAD Inc. shall not be liable for errors contained herein or for incidental or consequential damages (including lost profits) in connection with the furnishing, performance, or use of this material whether based on warranty, contract, or other legal theory.

This document contains trademarks owned by QAD Inc. and other companies.

Copyright ©2019 by QAD Inc.

DC_Transactions_UG_v2018EE.pdf/r9m

QAD Inc.

100 Innovation Place
Santa Barbara, California 93108
Phone (805) 566-6000
<http://www.qad.com>

Contents

Data Collection Transactions User Guide Change Summary	5
Chapter 1 Overview	1
Data Collection Transactions	2
Compatibility	2
Data Collection Transactions	3
Chapter 2 Inventory Transactions	13
Introduction	14
Inventory Transfer	14
Transfer	14
Transfer Item	15
Transfer Lot	20
Transfer Pack	25
Internal Item Label	29
Packaging	30
Pack Create by Pack Code	30
Pack Build by Item	33
Pack Build by LP	36
Pack Merge	37
Pack Remove	39
Pack Commission	41
Pack Decommission	43
Pack Split	44
Test Printer Setup	47
Label Format Setup	49
Inventory Adjustments	52
Recount - By Item/Lot	52
Issues Unplanned	54
Receipts Unplanned	56
Tag Count Entry - Pack	57
Tag Recount Entry - Pack	60
Quality Release/Reject Label	62

Chapter 3 Inbound Transactions65

Introduction 66
Purchase Receipts 66
 PO Shipper Create by Pack 66
 Inbound Receipts 69
 Purchase Order Receipts 70
 Pending PO Shipper Unload 74
 DO Receipt by Pack 79
 Inbound Label Print 82
 Material Putaway 83

Chapter 4 Outbound Transactions85

Introduction 86
Outbound Shipments 86
 SO Bulk Pick - Transfer 86
 SO Pre-Shipper Create 94
 Pre-Shipper Pick 98
 Pre-Shipper Pack 102
 Sub Contract Container 110
 Sub Contract Shipper Pick 115
 Pre-Shipper Convert to Shipper 118
 Truck Load 121
 DO Shipper Confirm 124
Shipment Modify 125
 Move Pack between Shipper 125
 Pack Merge 129
 Shipper LP Weight Modify 131
Outbound 134
 Shipper Labels 134
 Shipper Item Label 138
 License Plate Label 139

Chapter 5 Production Order Transactions141

Introduction 142
Production Order Menu 142
Production Order Transactions 143
 Material Request 143
 Material Pick-Transfer-Issue 148
 Material Transfer 177
 Material Issue 191
 Production Packaging 198
 Production Receipts 202
 Production Item Putaway 206

Chapter 6 EAM Transactions	211
Introduction	212
Inventory Transfer	212
Relocate	212
Part Lookup	214
Part Labels	215
Location Labels	217
Cycle Count	218
Adjust	218
Physical	220
Count Physical Inventory	220
Purchase Requisitions	221
PO Receipt	221
Stores Requisitions	224
Close Stores Requisitions	224
Part Lookup	225
Maintenance Reporting	225
Issue to WO	225
Issue to Equipment	227
Issue to Account	229
Return Material	230
Chapter 7 Installation Instructions	1
Installing Data Collection Transactions and Menus	2
Artifact Location	2
Importing Transactions and Menus	2
Verify Installation	7
Product Information Resources	9

4 QAD Data Collection Transactions User Guide

Data Collection Transactions User Guide Change Summary

The following table summarizes significant differences between this document and previous versions.

Date/Version	Description	Reference
March 2019 / 2018EE	Initial Release	--

Chapter 1

Overview

This chapter gives an overview of the Automation Solutions: Data Collection transactions:

Data Collection Transactions **2**

Data Collection Transactions

Before implementing QAD transactions, please note the following important information:

QAD published transactions are optimized for a paperless, directed-user experience that requires the fewest possible end-user data/scan entries. To achieve simplicity, generally the transactions do not provide the full functionality available in their desktop-back office .NET UI counterpart. For example, the inventory transfer function in the .NET UI can prompt for shipping details for intersite transfer; however, the published AS inventory transfer transaction does not. Moreover, AS transactions do not support negative values like some .NET UI programs do.

Note When additional capabilities are required, please contact QAD Services for help in personalizing the transactions for your business requirements.

The transactions described in this book are complete to the best of QAD's knowledge at the time of publishing. Unless otherwise specified, QAD does not guarantee, and makes no representations or warranties of any kind, as to the accuracy and completeness of the documentation.

Transactions that are modified are not supported by QAD. Please note that published transactions that are delivered in EE, EAM, and Production Orders cannot be modified. When additional capabilities are required in a transaction, users should create a copy of a published transaction; then, make changes to the copied version. QAD does not support copied transactions that have been modified.

QAD supports only published transactions that are certified for Enterprise Edition (EE) releases and Automation Solutions (AS) framework versions. When QAD provides transaction updates, it is the customer's responsibility to retrofit to a prior QAD EE release.

Compatibility

The following table outlines which QAD product versions are compatible and certified to work with Data Collection transaction banners.

Transaction Banners	Media Delivery	Certified On		
		2018EE	Channel Islands - San Miguel 2	Production Orders 3.0
ERP Inventory	Delivered in the 2018EE module package	✓	✓	✓
ERP Inbound		✓	✓	✓
ERP Outbound		✓	✓	✓
ERP Production	Delivered in the Production Order 3.0 module package	✓	✓	✓
EAM	Delivered in the EAM 2017.1EE module package			

For transaction compatibility on 2017 QAD EE, please see the *Automation Solutions: Data Collection Transactions 2017EE Release Notes*.

For transaction compatibility on QAD 2016 EE and QAD 2015 EE, please contact QAD Services or a certified implementation partner.

Data Collection Transactions

The following tables list the published Data Collection transactions that are provided with QAD 2018EE and Production Orders 3.0:

- ERP Inventory, Inbound, and Outbound Transactions
- ERP Production Transactions
- EAM Transactions

ERP Inventory, Inbound, and Outbound Transactions

The following published ERP Inventory, Inbound, and Outbound transactions are provided in QAD 2018 EE:

Table 1.1
ERP Inventory, Inbound, and Outbound Transactions (Page 1 of 5)

Category / Banner	Task	Menu #	Transaction Name	.NET Menu Name (Menu #, Program)	Description
Inventory	Inventory Transfer	1.1.1	Transfer	Trans: Inventory Transfer Parent App: Calls linked transactions	Scan Item#,LOT#,Serial# to transfer loose inventory (Items, Lots) or packaged materials
Inventory	Inventory Transfer	1.1.1.1-1	Linked from "Inventory Transfer Parent".	Trans: Inventory Transfer with Lot Serial Change - Item App: Inventory Transfer with Lot/Serial Change (3.4.3, iclotr03.p)	Transfer ITEM between locations.
Inventory	Inventory Transfer	1.1.1.1-2	Linked from "Inventory Transfer Parent".	Trans: Inventory Transfer with Lot Serial Change - Lot App: Inventory Transfer with Lot/Serial Change (3.4.3, iclotr03.p)	Transfer LOT between locations.
Inventory	Inventory Transfer	1.1.1.1-3	Linked from "Inventory Transfer Parent".	Trans: Pack Transfer with L/S Change App: Pack Transfer (3.17.8, papatr02.p)	Transfer PACK between locations.
Inventory	Inventory Transfer	1.1.2	Quality Release/Reject Label		
Inventory	Inventory Transfer	1.1.3	Internal Item Label		
Inventory	Packaging	1.3.1	Pack Create by Pack Code	Trans: Pack Create By Pack Code App: Pack Create by Pack Code (3.17.2, papacr01.p)	Create package ID (label) before receiving items/lots/serial inventory into it.
Inventory	Packaging	1.3.2	Pack Build - Item	Trans: Pack Build - Item App: Pack Build (3.17.3, papabd.p)	Create/add Item, Lots, or Serialized inventory to a pack.
Inventory	Packaging	1.3.3	Pack Build - LP	Trans: Pack Build - LP App: Pack Build (3.17.3, papabd.p)	Add an existing package to a new or existing parent package. For example, you can add several boxes to a pallet.
Inventory	Packaging	1.3.4	Pack Merge	Trans: Pack Merge App: Pack Merge (3.17.15, papamg.p)	Merge packages together for packages with Active and Picked stages.
Inventory	Packaging	1.3.5	Pack Remove	Trans: Pack Remove App: Pack Remove (3.17.5, paparm.p)	Remove and transfer items or child packs from a master pack.

Table 1.1
ERP Inventory, Inbound, and Outbound Transactions (Page 2 of 5)

Category / Banner	Task	Menu #	Transaction Name	.NET Menu Name (Menu #, Program)	Description
Inventory	Packaging	1.3.6	Pack Commission	Trans: Pack Commission App: Pack Commission (3.17.4, papacm.p)	Activate an inactive serial ID, providing the ability for users to transact against it.
Inventory	Packaging	1.3.7	Pack Decommission	Trans: Pack Decommission App: Pack Decommission (3.17.6, papadecm.p)	Decommission a license plate or serial ID, preventing transaction processing against it.
Inventory	Packaging	1.3.8	Pack Split	Trans: Pack Split App: Pack Split (3.17.16, papasp.p)	Split a package into multiple packages.
Inventory	Adjustment	1.7.1	Recount - Item	Trans: Inventory Adjustment Entry - Recount Item App: Inventory Adjustment Entry (3.13.2, icccaj.p)	Perform recount count for item.
Inventory	Adjustment	1.7.2	Recount - Lot	Trans: Inventory Adjustment Entry - Recount Lot App: Inventory Adjustment Entry (3.13.2, icccaj.p)	Perform recount count for Lot.
Inventory	Adjustment	1.7.4	Issues - Unplanned	Trans: Issues - Unplanned App: Issues - Unplanned (3.7, icunis.p)	Perform a issues unplanned for item/lot.
Inventory	Adjustment	1.7.5	Receipts - Unplanned	Trans: Receipts - Unplanned App: Receipts - Unplanned (3.9, icunrc.p)	Perform a receipt unplanned for item/lot.
Inventory	Adjustment	1.7.7	Tag Count Entry - Pack	Trans: Tag Count Entry - LP App: Pack Tag Count Entry (3.16.3.3, paptcc.p) Linked Trans: Tag Recount Entry linked	Perform a Tag Count for packaged and loose inventory. Replaces: picmt2.p
Inventory	Adjustment	1.7.8	Tag Recount Entry - Pack	Trans: Tag Recount Entry - LP App: Pack Tag Recount Entry (3.16.3.4, paptrc.p) Linked Trans: Tag Recount Entry linked	Perform a Tag Recount for packaged and loose inventory. Replaces: picmt2.p
Inbound	Purchase Receipts	3.1.1	PO Shipper Create by Pack	Trans: PO Shipper Maintenance by Pack App: PO Shipper Maintenance (5.13.14, rsshmt.p)	Create a Shipper with packaging units. This is applicable when ASN's are not received via EDI or you desire to license plate incoming purchase receipts.
Inbound	Purchase Receipts	3.1.2	Inbound Receipts	Trans: Inbound Receipts Parent App: Calls linked transactions	Scan Shipper ID, Serial ID, PO# to receive against: PO/DO Shipper, Purchase Order
Inbound	Purchase Receipts	3.1.2.2-1	Linked from "Inbound Receipts Parent"	Trans: Purchase Order Receipts App: Purchase Order Receipts (5.13.1, poporc.p)	Receive against discrete and scheduled orders.

Table 1.1
ERP Inventory, Inbound, and Outbound Transactions (Page 3 of 5)

Category / Banner	Task	Menu #	Transaction Name	.NET Menu Name (Menu #, Program)	Description
Inbound	Purchase Receipts	3.1.2.2-2	Linked from "Inbound Receipts Parent"	Trans: Pending PO Shipper Unload by Pack App: Pending PO Shipper Unload (5.13.12.13)	Receive packs, validating against a pre-shipper.
Inbound	Purchase Receipts	3.1.2.2-3	Linked from "Inbound Receipts Parent"	Trans: DO Receipt By Pack App: DO Receipt By Pack (12.9.13 padorc.p)	Confirm a shipper receipt of pack.
Inbound	Purchase Receipts	3.1.3	Inbound Label Print	Trans: PO Label Print App: NA	Print/reprint inbound receipts label.
Inbound	Purchase Receipts	3.1.4	Material Putaway	Trans: Production Order Item Putaway App: Inventory Transfer with Lot/Serial Change (3.4.3, iclotr03.p)	Directs material handlers where to put away received materials. Note: Requires implementation services to refine/develop putaway rules/logic. The putaway logic provided with this transaction is not supported and is used for reference only.
Outbound	Outbound Shipment	7.1.1	SO Bulk Pick - Transfer	Trans: Transfer With Lot/Erial Change - SO Bulk Pick App: Inventory Transfer (3.4.3, iclotr03.p)	Directs user to pick and transfer materials from warehouse to a packaging staging area, where users will later pick and package per pre-shipper requirements.
Outbound	Outbound Shipment	7.1.2	SO Pre-Shipper Create	Trans: Pre-Shipper-Shipper Picking - Create Shipper App: Pre-Shipper/Shipper Picking (7.8.1, pasopi.p)	Scan LP and create Sales Order Pre-Shipper on demand.
Outbound	Outbound Shipment	7.1.3	Pre-Shipper Pick	Trans: Pre-Shipper-Shipper Picking-by LP PARENT App: Calls linked transactions	Pre-Shipper picking for SO and DO where inventory is License Plated and you pick it per pre-shipper requirements.
Outbound	Outbound Shipment	7.1.3-1	Linked	Trans: Pre-Shipper-Shipper Picking - Pick by LP App: Pre-Shipper/Shipper Picking (7.8.1, pasopi.p)	Called as linked transaction from parent transaction Pre-Shipper Pick - PARENT.
Outbound	Outbound Shipment	7.1.3-2	Linked	Trans: Pre-Shipper-Shipper Picking - by DO App: Pre-Shipper/Shipper Picking (12.9.1, padopi.p)	Called as linked transaction from parent transaction Pre-Shipper Pick - PARENT.
Outbound	Outbound Shipment	7.1.4	Pre-Shipper Pack	Trans: Pre-Shipper-Shipper Pack Build-PARENT App: Calls linked transactions	Pre-Shipper picking for SO and DO where inventory is loose and you pick and package it per pre-shipper requirements.

Table 1.1
ERP Inventory, Inbound, and Outbound Transactions (Page 4 of 5)

Category / Banner	Task	Menu #	Transaction Name	.NET Menu Name (Menu #, Program)	Description
Outbound	Outbound Shipment	7.1.4-1	Linked	Trans: Pre-Shipper-Shipper Pack Build - DO App: Pre-Shipper/Shipper Pack Build (12.9.2 padopa.p) Linked Trans: Pack Transfer linked with prompt Linked Trans: LP Weight Modify linked with prompt Linked Trans: Transfer With Lot-Serial Change - Item Version	Called as linked transaction from parent transaction Pre-Shipper Pack Build - PARENT.
Outbound	Outbound Shipment	7.1.4-2	Linked	Trans: Pre-Shipper-Shipper Pack Build - Item - SO App: Pre-Shipper/Shipper Pack Build (7.8.2, pasopa.p) Linked Trans: Pack Transfer linked with prompt Linked Trans: LP Weight Modify linked with prompt Linked Trans: Transfer With Lot-Serial Change - Item Version	Called as linked transaction from parent transaction Pre-Shipper Pack Build - PARENT.
Outbound	Outbound Shipment	In package - not on menu	Sub Contract Container	Trans: Sub Container Maintenance App: Sub Container Maintenance (18.22.5.4, rectmt.p)	Create Containers (License Plate) for shipment.
Outbound	Outbound Shipment	In package - not on menu	Sub Contract Shipper Pick	Trans: Sub Shipper Maintenance App: Sub Shipper Maintenance (18.22.5.5, reshmt.p)	Create Shipper, associate containers (License Plate) to Shipper.
Outbound	Outbound Shipment	7.1.7	Pre-Shipper Convert to Shipper	Trans: Pre-Shipper Convert - Parent App: PreShipper/Shipper Print (7.9.4, rcrp13.p)	Convert SO/DO Pre-shipper to Shipper
Outbound	Outbound Shipment	7.1.8	Truck Load	Trans: Truck Load App: Truck Load (7.8.4, patrkld.p)	Validate content loaded into truck matches Shipper.
Outbound	Outbound Shipment	7.1.9	DO Shipper Confirm	Trans: DO Pre-Shipper-Shipper Confirm App: DO Pre-Shipper/Shipper Confirm (12.19.13, dodsois.p)	Confirm DO Shipper.
Outbound	Shipment Modify	7.2.1	Move Pack between Shipper	Trans: Move Pack Between Pre-Shippers - Parent App: Linked Transactions	Move License Plates between SO/DO (Pre)Shippers for same ship-to.

Table 1.1
ERP Inventory, Inbound, and Outbound Transactions (Page 5 of 5)

Category / Banner	Task	Menu #	Transaction Name	.NET Menu Name (Menu #, Program)	Description
Outbound	Shipment Modify	7.2.1.1-1	Linked	Trans: Move Pack Between Pre-Shippers - SO App: Move Pack Between (Pre)Shippers (7.8.12, pasoshmv.p)	Move License Plates between SO (Pre)Shippers for same ship-to.
Outbound	Shipment Modify	7.2.1.1-2	Linked	Trans: Move Pack Between Pre-Shippers - DO App: Move Pack Between (Pre)Shippers (12.9.12, padoshmv.p)	Move License Plates between DO (Pre)Shippers for same ship-to.
Outbound	Shipment Modify	7.2.2	Pack Merge	Trans: Pack Merge App: 3.17.15 papamg.p	Merges License Plates and Packs within a (Pre)Shipper.
Outbound	Shipment Modify	7.2.3	Shipper LP Weight Modify	Trans: Shipper Data Maintenance App: Shipper Data Maintenance (7.8.6, patkwt.p) Linked Trans: License Plate Label Version	Modify weights of License Plates in (Pre)Shipper and reprint label.
Outbound	Outbound	7.2.4	Shipper Labels	Trans Shipper Labels App: NA	Print/Reprint all or specific label groups for a shipper or specific License Plate.
Outbound	Outbound	7.2.5	Shipper Item Label	Trans: Customer Item Label App: NA	Print/Reprint shipper item labels.
Outbound	Outbound	7.2.6	License Plate Label	Trans: License Plate Label App: NA	Print/Reprint License Plate labels.

ERP Production Transactions

The following published ERP Production transactions are provided in the Production Orders 3.0 module:

Table 1.2
ERP Production Transactions (Page 1 of 3)

Category / Banner	Task	Menu #	Transaction Name	.NET Menu Name (Menu #, Program)	Description
Production	Production	5.1.1	Material Request	Trans: Production Order Replenishment Request App: Inventory Transfer (3.4.3, iclotr03.p)	Create a line side material request for a resource location where consumption / backflush will occur.
Production	Production	5.1.3	Material Pick-Transfer-Issue	Trans: Production Order Pick-Transfer-Issue App: Several linked transactions called: <ul style="list-style-type: none"> • Pack Split (3.17.16, papasp.p) • Pack Remove (3.17.15, paparm.p) • Pack Build (3.17.3, papabd.p) • Pack Merge (3.17.15, papamg.p) • Pack Create by Pack Code (3.17.2, papacr01.p) • Production Order Manual Allocation (16.5.2, womall.p) • Production Order Picklist Pick by Item (16.5.7, wopkpp.p) • Production Order Picklist Pick by Pack (16.5.7, wopkpp.p) • Production Order Picklist Transfer (16.5.9, wopkis.p) • Production Order Picklist Issue by Item (16.5.11, woispck.p) • Production Order Picklist Issue by Pack (16.5.11, woispck.p) • Production Order Component Issue by Pack (16.5.12, woisord.p) • Production Order Component Issue by Item (16.5.12, woisord.p) • Kanban Consume/Fill (17.6.1, kbtr1.p) • Inventory Transfer (3.4.3, iclotr03.p) • Pack Transfer (3.17.8, papatr02.p) 	<p>Replenish work centers with component requirements driven by several replenishment signals:</p> <ul style="list-style-type: none"> • Manual Line Side replenishment request • Scheduled production orders generating component replenishment by work center backflush locations • Production Order Picklists • Kanban fill requests <p>Picking materials which are loose or packaged units.</p> <p>Picking and kitting materials by production order.</p> <p>Transferring those materials to holding, reserved, or backflush locations.</p>

Table 1.2
ERP Production Transactions (Page 2 of 3)

Category / Banner	Task	Menu #	Transaction Name	.NET Menu Name (Menu #, Program)	Description
Production	Production	5.1.4	Material Transfer	Trans: Production Order Transfer Parent App: Calls linked transactions <ul style="list-style-type: none"> • Production Order Manual Allocation (16.5.2, womall.p) • Production Order Picklist Transfer (16.5.9, wopkis.p) • Inventory Transfer (3.4.3, iclotr03.p) • Pack Transfer (3.17.8, papatr02.p) • Pack Decommission (3.17.6, papadecm.p) 	Transfer kitted production order or picklist picked materials to production line or work center location.
Production	Production	5.1.5	Material Issue	Trans: Production Order Parent Component Issue App: Calls linked transactions <ul style="list-style-type: none"> • Production Order Picklist Issue by Item (16.5.11, woispck.p) • Production Order Picklist Issue by Pack (16.5.11, woispck.p) • Production Order Component Issue (16.5.11, woispck.p) 	Issue components to production orders directly or through a picklist.
Production	Production	5.1.6	Packaging	Trans: Production Order Packaging Parent App: Calls linked transactions <ul style="list-style-type: none"> • Pack Create by Production Order 16.5.17, pawocr.p • Pack Create by Production Line (16.5.18, palncr.p) • Pack Build (3.17.3, papabd.p) 	Create packaging IDs for scheduled and discrete production orders. Add items (Pack Build) to existing package ID.
Production	Production	5.1.7	Production Receipts	Trans: Production Orders Reporting - Parent App: Calls linked transactions <ul style="list-style-type: none"> • Operation Activity Reporting • Kanban Consume/Post 	Report production for an operation or final receipt into stock and receiving serial/lot/item into a pack for discrete and scheduled production orders.
Production	Production	5.1.7-1	Linked	Trans: Operation Activity Reporting - Production Only App: Operation Activity Reporting (16.13.13, woopact.p)	Report production for an operation or final receipt into stock and receiving serial/lot/item into a pack for discrete and scheduled production orders.

Table 1.2
ERP Production Transactions (Page 3 of 3)

Category / Banner	Task	Menu #	Transaction Name	.NET Menu Name (Menu #, Program)	Description
Production	Production	5.1.7-2	Linked	Trans: Kanban Consume/Post App: Kanban Consume-Post (17.6.1, kbtr1.p)	Consume/Post against a Kanban ID.
Production	Production	5.1.9	Material Putaway	Trans: Production Order Item Putaway App: Transfer Single Item (3.4.3, iclotr03.p)	Directs material handlers where to put away produced materials. Note: Requires implementation services to refine/develop putaway rules/logic. The putaway logic provided with this transaction is not supported and is used for reference only.
Production	Production	5.1.20	Internal Item Label		

EAM Transactions

The following published EAM transactions are included in the EAM 2017.1EE module:

Table 1.3
EAM Transactions (Page 1 of 2)

Category / Banner	Task	Menu #	Transaction Name	.NET Menu Name (Menu #, Program)	Description
EAM Inventory	Inventory Transfer	2.1.1.1	Relocate	Trans: Inventory Transfer App: Inventory browse Relocate action	Transfer an item between locations.
EAM Inventory	Inventory Transfer	2.1.1.20	Part Lookup	Trans: Inventory search App: Inventory browse Find Field	Search for a part record.
EAM Inventory	Inventory Transfer	2.1.1.30	Part Labels	Trans: EAM Part Labels	Print labels for an item that contains item information.
EAM Inventory	Inventory Transfer	2.1.1.31	Location Labels	Trans: Bin Labels	Print labels for an item that contains location information.
EAM Inventory	Cycle Count	2.1.5.1	Adjust	Trans: Adjust App: Inventory browse Inventory Action	Adjust on hand quantity for a part location.
EAM Inventory	Physical	2.1.7.1	Count Physical Inventory	Trans: Count Physical Inventory App: Inventory Physical Inventory	Record count for a part and its location.
EAM Inbound	Purchase Requisitions	2.2.1.1	PO Receipt	Trans: PO Receipt App: Purchase Order browse Receive Action	Receive items against a purchase order.

Table 1.3
EAM Transactions (Page 2 of 2)

Category / Banner	Task	Menu #	Transaction Name	.NET Menu Name (Menu #, Program)	Description
EAM Stores Requisitions	Stores Requisitions	2.3.2	Close Stores Requisition	Trans: Close Stores Requisition App: Inventory Stores Requisition Change Status Action	Change Stores Requisition status.
EAM Stores Requisitions	Stores Requisitions	2.3.3	Part Lookup	Trans: Inventory lookup App: Inventory Stores Requisition Second browse New Part Lookup	Look up a part to include on a Stores Requisition List.
EAM Maintenance	Maintenance Reporting	2.5.1.1	Issue to WO	Trans: Issue to WO App: Inventory Browse Issue Action Enter work order number	Issue a part to a work order.
EAM Maintenance	Maintenance Reporting	2.5.1.2	Issue to Equipment	Trans: Issue to Equipment App: Inventory Browse Issue Action Enter equipment number	Issue a part to a piece of equipment.
EAM Maintenance	Maintenance Reporting	2.5.1.4	Issue to Account	Trans: Issue to Account App: Inventory Browse Issue Action Enter cc/acct/sub account number	Issue a part to a Cost Center/Account/Sub Account.
EAM Maintenance	Maintenance Reporting	2.5.1.5	Return Material	Trans: Return App: Inventory Browse Return Action	Return a part to Inventory.

Inventory Transactions

This chapter describes detailed technical information for the Automation Solutions: Data Collection Inventory transactions:

Introduction 14

Inventory Transfer 14

Packaging 30

Inventory Adjustments 52

Introduction

This chapter covers the following transactions:

- Transfer
- Transfer Item
- Transfer Lot
- Transfer Pack
- Pack Create by Pack Code
- Pack Build by Item
- Pack Build by LP
- Pack Merge
- Pack Remove
- Pack Commission
- Pack Decommission
- Pack Split
- Recount - By Item/Lot
- Issues Unplanned
- Receipts Unplanned
- Tag Count Entry - Pack
- Tag Recount Entry - Pack
- Internal Item Label

Inventory Transfer

Transfer

Inventory Transfer is the parent transaction that determines if the bar-code scanned is an item number, lot number, or serial number. Then, the system automatically determines the correct QAD transfer to perform. Inventory Transfer can be used to transfer serialized and loose inventory. This transaction is only available in 2018EE.

Transaction Technical

DC Menu	DC Menu Name	DC Transaction Technical Name	Production Order .NET Menu Action
1.1.1	Inventory Transfer	Transfer	Trans: Inventory Transfer Parent App: Calls linked transactions

Fig. 2.1
Inventory Transfer

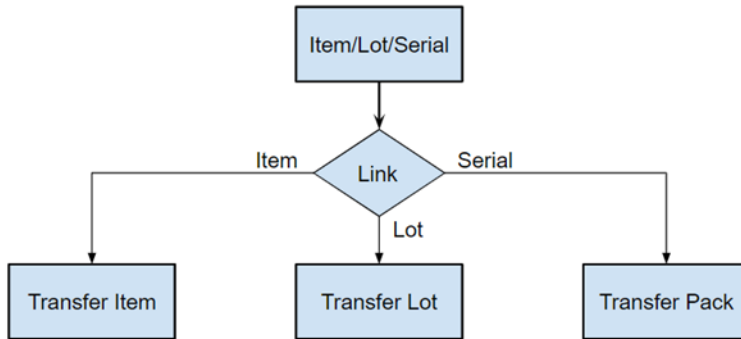

Field Information

Field Name	Comments
tt...	
ID (Data entry field)	<p>If user scans a Serial ID, Transfer Pack is called.</p> <p>If user scans a Item Lot Number/Ref, 3.4.3 Transfer Lot is called.</p> <p>If user scans a Item Number, Transfer Item is called.</p>

Transfer Item

Transfer an item between locations. The transaction starts with From Location and includes advanced putaway logic.

Transaction Technical

DC Menu	DC Menu Name	DC Transaction Technical Name	Production Order .NET Menu Action
1.1.1.1-1	Inventory Transfer	Linked from "Inventory Transfer Parent."	<p>Trans: Inventory Transfer with Lot Serial Change - Item</p> <p>App: Inventory Transfer with Lot/Serial Change (3.4.3, iclotr03.p)</p>

Bar Code Format

- Linear Codes 1D multi-field as well as single field.
- Prefixes used.
- The separator needs to be configurable and its currently ":". Ascii code 58 (to verify).
- The format is: <Item>:<Lot/Ser>:<Ref>:<Quantity>.
- Label examples in the Labels Section.

Transaction Flow Chart

Fig. 2.2
Transfer Item

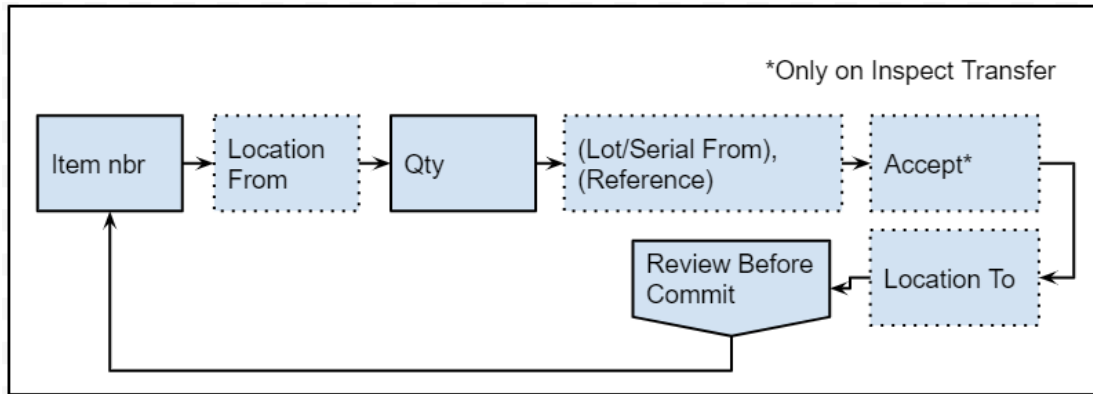
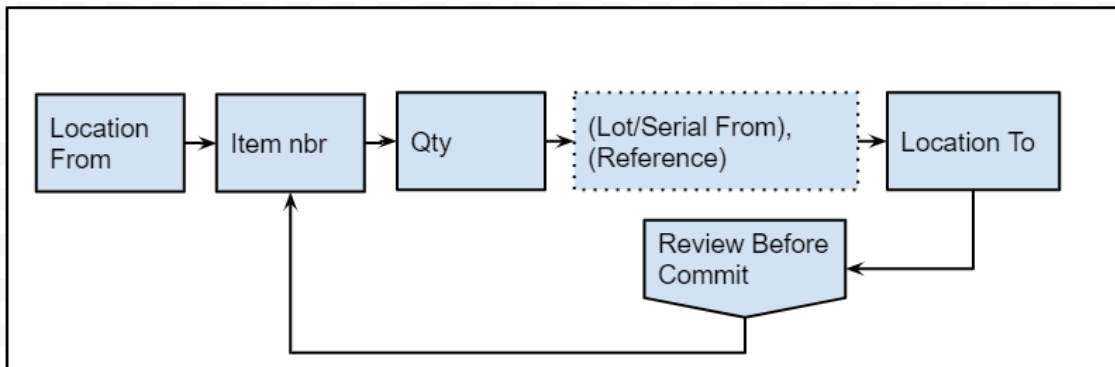

Fig. 2.3
Transfer Item Putaway



Limitations/Exceptions

- Does not directly support consignment inventory, electronic signatures, inter-site transfers (which generate shipping documentation), Supplier Performance (quality measurements).
- The pop-up for Supplier Performance should be conditional, depending on the FROM location of the transfer. When the FROM location matches the Inspection Location (from Purchasing Control) then the pop-up allows the entry of Quality measurements for Supplier Performance.
- Packing Structures Supported by the Transaction. For non-serial items, the transaction only supports loose inventory transactions.

Setup Considerations

Inv Transfer Restriction Maintenance (36.3.7.1). Provide ability to restrict inventory transfers by location per the criteria options seen below.

Fig. 2.4
Item Transfer - Setup Considerations

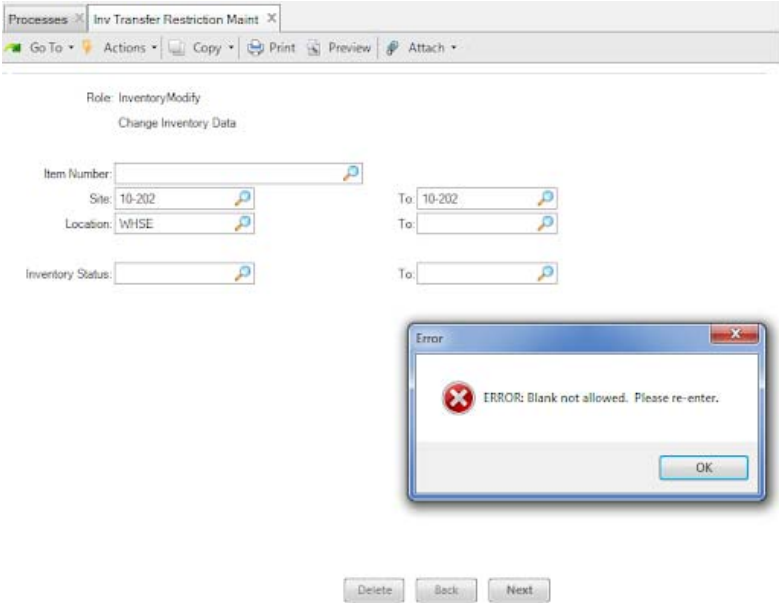

Minimum Data Required

N/A

Field Information

Field Name	Comments
tt...	
Item <i>(Data entry field)</i>	Input/Lookup/scan of item number. Lookup Name: Item Number Auto-display: No Look-up Query Rules: Lookup Fields: Item Number (Sort 1 Ascending) Validation: For the Advanced Putaway Version, add validation to check for Gen Code setup for user site/log-in. Present error message “Generalized Code Not Defined.”
Description	Displays the description of the input/scanned item.
Loc Zone	The default location type this inventory should be received into per Item Site / Item Master, QAD reserved field <code>pti_site_loc</code> .
UM	Displays the unit of measure of the input/scanned item.

Field Name	Comments
Loc From <i>(Data entry field)</i>	The prompting and behavior of this field is different for each of the 3 inventory transfer flavors. Validation: <ul style="list-style-type: none"> • Location cannot be same as Loc From. • Location is valid for user/site. Lookup Name: All locations for item Auto-display: No Default Selected Values: Location Look-up Query Rules: <ul style="list-style-type: none"> • Locations per the user log-in site. • Find/display first Non-Zero balance inventory locations per selected item number. • Note: Displays the location one time even though multiple ld_dets may exist. • Note: Location type should not be an input. Lookup Fields: <ul style="list-style-type: none"> • Location (Sort 1 Ascending) • QOH (->>, >>9.9) • Created (Sort 2 Ascending) • Zone: The Location Type field in Location Maintenance. Used to define the Zone of the location. • Loc Stat
Lot/Serial From <i>(Data entry field)</i>	Only applicable if inventory in the From Location has lots. Otherwise user is not prompted.
Reference From <i>(Data entry field)</i>	Only applicable if inventory in the From Location has lots. Otherwise user is not prompted. Field not mandatory if there is no Reference tied to the Lot/Serial number.
Qty <i>(Data entry field)</i>	Input quantity to transfer. Validation: QTY is available to transfer, user cannot transfer more than available to transfer. <div style="text-align: center;">  ERROR: Quantity available in site location for lot/serial 40. Please re-enter. </div> <hr style="width: 50%; margin: 10px auto;"/>

Field Name	Comments
Loc To <i>(Data entry field)</i>	Enter/Select location to transfer item to. Validation: <ul style="list-style-type: none"> • Location cannot be same as Loc From. • Location is valid for user/site. The following look-ups can be called: <ul style="list-style-type: none"> • <i>Non-Zone Logic.</i> If Zone Storage Location (pti_det.pti_site_loc) = “blank” per item, then use Current Item Inventory look-up. • <i>Zone Logic.</i> If Zone Storage Location (pti_det.pti_site_loc) = “non-blank” per item, then use Putaway look-up. Non-Zone Logic Lookup Name: Current Item Inventory Auto-display: Yes Default Selected Values: Location Look-up Query Rules: <ul style="list-style-type: none"> • Find/display Non-Zero balance inventory locations per selected item number. • Do not display locations of selected Location From. • Do not display location more than once (consolidate the inventory quantities if multiple lot records exist). • Do not default Loc To value if selected from look-up Look-up Fields: <ul style="list-style-type: none"> • Location (Sort 2 Ascending) • QOH (->>, >>>9.9) • Created (Sort 1 Ascending) • Zone (pti_site_loc) • Loc Stat Basic Zone Logic Lookup Name: Putaway Locations (original version) Auto-display: Yes Default Selected Values: Location Look-up Query Rules: <ul style="list-style-type: none"> • Find/display Non-Zero balance inventory locations per selected item number where Location Type (loc_mstr.loc_type) = Zone Storage Location (pti_det.pti_site_loc) • Do not display locations of selected Location From. • Do not display location more than once. Consolidate the inventory quantities if multiple lot records exist. • Find/display inventory locations with Location Type (loc_mstr.loc_type) = to Zone Storage Location (pti_det.pti_site_loc) per item site master where Zero balance, including locations where an ld_det record does not exist. • Do not default Loc To value if selected from look-up. Design Note: This browse is built using a procedure dcintrxr.p
Loc Zone	Per the selected Loc To value, display putaway(zone) per location maintenance location type loc_mstr.loc_type.
Review Before Commit <i>(Data entry field)</i>	Any input entered will complete the transaction. If data is incorrect, user should F4 back to correct it.

Troubleshooting

Issue/Error	Root/Solution
	<p>Per Inv Transfer Restriction Maintenance, user ROLE does not have permission to transfer inventory.</p> <ul style="list-style-type: none"> • See Inv Restriction Maintenance for settings. • See Role Permissions to see associated roles of users. • See “Setup Considerations” on page 16.
<p>In Component Pick-Transfer, after a component is picked, the transfer fails and displays message MFG-361 “Inventory status is not defined.”</p>	<p>We can have a blank status code defined or we can have a default event on the ldstatus field to default from locFromStatus (same as in inventory transfer by lot). This will require some testing, too.</p>

Transfer Lot

Transfer a LOT between locations. Transaction starts with From Location and includes advanced putaway logic.

Transaction Technical

DC Menu	DC Menu Name	DC Transaction Technical Name	Production Order .NET Menu Action
1.1.1.1-2	Inventory Transfer	Linked from “Inventory Transfer Parent.”	Trans: Inventory Transfer with Lot Serial Change - Lot App: Inventory Transfer with Lot/Serial Change (3.4.3, iclotr03.p)

Bar Code Format

- Linear Codes 1D multi-field as well as single field.
- Prefixes used.
- The separator needs to be configurable and its currently “:”. Ascii code 58 (to verify)
- The format is: <Item>:<Lot/Ser>:<Ref>:<Quantity>.
- Label examples in the Labels Section.

Transaction Flow Chart

Fig. 2.5
Transfer Lot

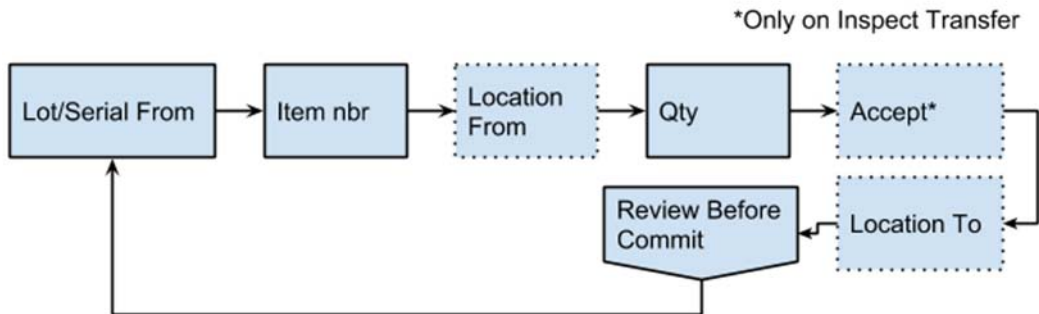
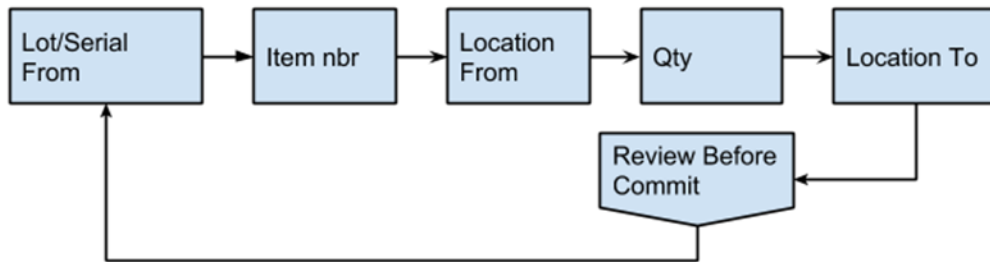

Fig. 2.6
Transfer Lot Putaway



Limitations/Exceptions

- Does not directly support consignment inventory, electronic signatures, inter-site transfers that generate shipping documentation.
- Supplier Performance must be disabled per API Defect.
- Packing Structures Supported by the Transaction. For non-serial items, the transaction only supports loose inventory transactions.

Status Conflicts

When transferring inventory with an inventory status conflict, the program prompts for which status (To Location or From Location status) to use for the transfer.

It also depends if you are transferring inventory to a location that does not have any quantity on hand.

The API is available for Transfer With Lot/Serial Change (3.4.3), which uses the following logic for status conflict:

- If status conflict and quantity on hand at To Location is zero, then it uses status defined in `ttTransLotSerial.Idstatus` field if executed in API mode; if in non-api mode, it will prompt for status to use.

- If status conflict and quantity on hand is not zero, then it will use To Location status if ttTransLotSerial.useto is set to Yes; otherwise it will not process the transaction in API mode. If in non-api mode, it will prompt you with a question to use To Location status or it will not process the transfer.

If the user does not want to process the transaction because of a status conflict, they can do the following:

- Add a validation for status conflict and block user from committing transaction.
- or,
- Set useto field to No and update ldstatus field with same status as inventory of From Location(ld_det.ld_status). If To Location qty on hand is not zero, transaction will not be processed, and if To Location qty on hand is zero then transfer will happen but status will not be changed.

Setup Considerations

Inv Transfer Restriction Maintenance (36.3.7.1). Provide ability to restrict inventory transfers by location per the criteria options shown below.

Fig. 2.7
Item Transfer - Setup Considerations

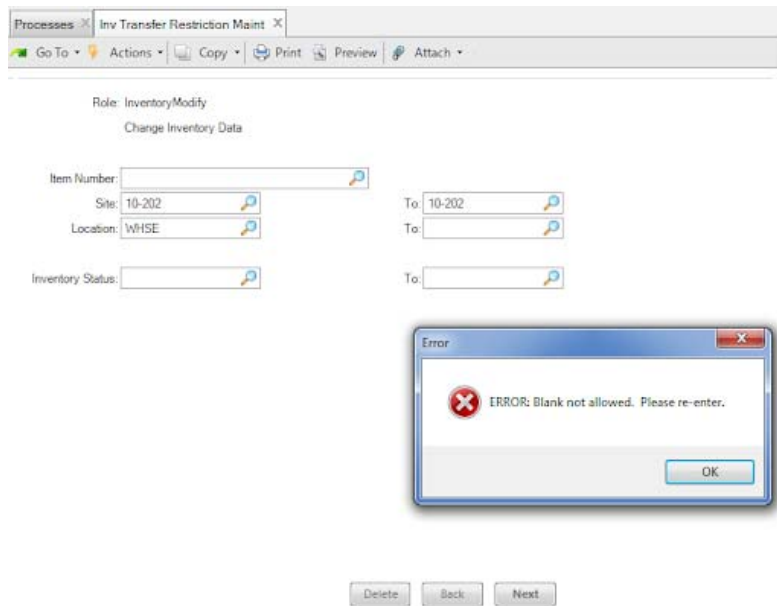

Minimum Data Required

N/A

Field Information

Field Name	Comments
tt...	
Lot (Data entry field)	<p>Input/Lookup/Scan of Lot Number</p> <p>Validation: Validate Lot Number exists</p> <p>Lookup Name: Lot/Serial</p> <p>Auto-Display: No</p> <p>Lookup Fields:</p> <ul style="list-style-type: none"> • Lot Number • Reference • Item • Location • Quantity on Hand
Item (Data entry field)	<p>Input/Lookup/scan of item number.</p> <p>Conditional: If the same lot is used for multiple items, then the system prompts for the item.</p> <p>Validation: For the Advanced Putaway Version, add validation to check for Gen Code setup for user site/log-in. Present error message, "Generalized Code Not Defined."</p> <p>Lookup Name: Item Number</p> <p>Auto-display: No</p> <p>Look-up Query Rules:</p> <p>Lookup Fields: Item Number (Sort 1 Ascending)</p>
Description	Displays the description of the input/scanned item.
Loc Zone	The default location type this inventory should be received into per Item Site / Item Master, QAD reserved field pti_site_loc.
UM	Displays the unit of measure of the input/scanned item.
Loc From (Data entry field)	<p>The prompting and behavior of this field is different for each of the 3 inventory transfer flavors.</p> <p>Validation:</p> <ul style="list-style-type: none"> • Location cannot be same as Loc From. • Location is valid for user/site. <p>Lookup Name: All locations for item</p> <p>Auto-display: No</p> <p>Default Selected Values: Location</p> <p>Look-up Query Rules:</p> <ul style="list-style-type: none"> • Locations per the user log-in site. • Find/display first Non-Zero balance inventory locations per selected item number. • Note: Displays the location one time even though multiple ld_dets may exist. • Note: Location type should not be an input. <p>Lookup Fields:</p> <ul style="list-style-type: none"> • Location (Sort 1 Ascending) • QOH (->>>9.9) • Created (Sort 2 Ascending) • Zone: The Location Type field in Location Maintenance. Used to define the Zone of the location. • Loc Stat

Field Name	Comments
Qty <i>(Data entry field)</i>	<p>Input quantity to transfer.</p> <p>Validation: QTY is available to transfer user, cannot transfer more than available to transfer.</p> <div style="text-align: center;">  <p>ERROR: Quantity available in site location for lot/serial 40. Please re-enter.</p> </div>
Loc To <i>(Data entry field)</i>	<p>Enter/Select location to transfer item to.</p> <p>Validation:</p> <ul style="list-style-type: none"> • Location cannot be same as Loc From. • Location is valid for user/site. <p>The following look-ups can be called:</p> <ul style="list-style-type: none"> • <i>Non-Zone Logic.</i> If Zone Storage Location (pti_det.pti_site_loc) = “blank” per item, then use Current Item Inventory look-up. • <i>Zone Logic.</i> If Zone Storage Location (pti_det.pti_site_loc) = “non-blank” per item, then use Putaway look-up. <p>Non-Zone Logic</p> <p>Lookup Name: Current Item Inventory</p> <p>Auto-display: Yes</p> <p>Default Selected Values: Location</p> <p>Look-up Query Rules:</p> <ul style="list-style-type: none"> • Find/display Non-Zero balance inventory locations per selected item number. • Do not display locations of selected Location From. • Do not display location more than once. Consolidate the inventory quantities if multiple lot records exist. • Do not default Loc To value if selected from look-up. <p>Look-up Fields:</p> <ul style="list-style-type: none"> • Location (Sort 2 Ascending) • QOH (->>, >>>9.9) • Created (Sort 1 Ascending) • Zone (pti_site_loc) • Loc Stat <p>Basic Zone Logic</p> <p>Lookup Name: Putaway Locations (original version)</p> <p>Auto-display: Yes</p> <p>Default Selected Values: Location</p> <p>Look-up Query Rules:</p> <ul style="list-style-type: none"> • Find/display Non-Zero balance inventory locations per selected item number where Location Type (loc_mstr.loc_type) = Zone Storage Location (pti_det.pti_site_loc). • Do not display locations of selected Location From. • Do not display location more than once. Consolidate the inventory quantities if multiple lot records exist. • Find/display inventory locations with Location Type (loc_mstr.loc_type) = to Zone Storage Location (pti_det.pti_site_loc) per item site master where Zero balance, including locations where an ld_det record does not exist. • Do not default Loc To value if selected from look-up. <p>Design Note: This browse is built using a procedure dcintrrx.p</p>

Field Name	Comments
Loc Zone	Per the selected Loc To value, display putaway(zone) per location maintenance location type loc_mstr.loc_type.
Review Before Commit (Data entry field)	Any input entered will complete the transaction. If data is incorrect, user should F4 back to correct it.

Troubleshooting

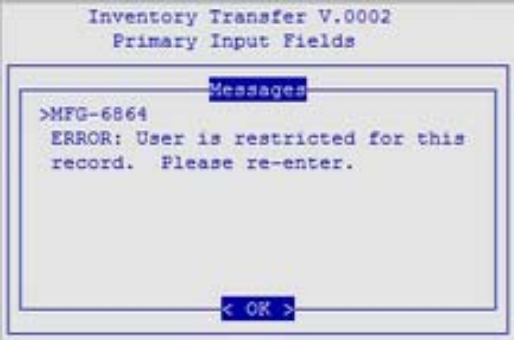
Issue/Error	Root/Solution
	<p>Per Inv Transfer Restriction Maintenance, user ROLE does not have permission to transfer inventory.</p> <ul style="list-style-type: none"> • See Inv Restriction Maintenance for settings. • See Role Permissions to see associated roles of users. • See “Setup Considerations” on page 22.
<p>In Component Pick-Transfer, after a component is picked, the transfer fails and displays message MFG-361 “Inventory status is not defined.”</p>	<p>We can have a blank status code defined, or we can have a default event on the ldstatus field to default from locFromStatus (same as in inventory transfer by lot). This will require some testing, too.</p>

Transfer Pack

Transfer a pack between locations. The transaction starts with From Location and includes advanced putaway logic.

Transaction Technical

DC Menu	DC Menu Name	DC Transaction Technical Name	Production Order .NET Menu Action
1.1.1.1-3	Inventory Transfer	Linked from “Inventory Transfer Parent.”	Trans: Pack Transfer with L/S Change App: Pack Transfer (3.17.8, papatr02.p)

Bar Code Format

- Linear Codes 1D multi-field as well as single field.
- Prefixes used.
- The separator needs to be configurable and its currently “:”. Ascii code 58 (to verify).
- The format is: <Item>:<Lot/Ser>:<Ref>:<Quantity>.
- Label examples in the Labels Section.

Transaction Flow Chart

Fig. 2.8
Transfer Pack Putaway

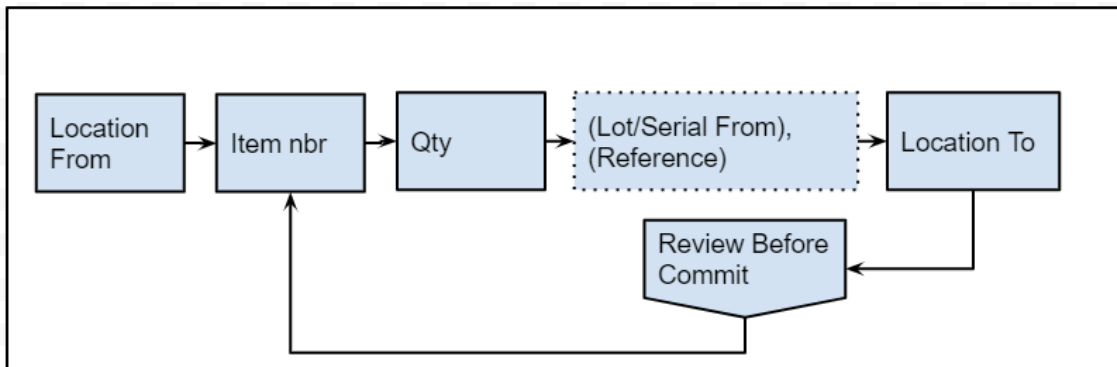

Limitations/Exceptions

- Supplier Performance must be disabled per API Defect.
- Packing Structures Supported by the Transaction. For non-serial items, the transaction only supports loose inventory transactions.

Setup Considerations

Inv Transfer Restriction Maintenance (36.3.7.1). Provide ability to restrict inventory transfers by location per the criteria options shown below.

Fig. 2.9
Item Transfer - Setup Considerations

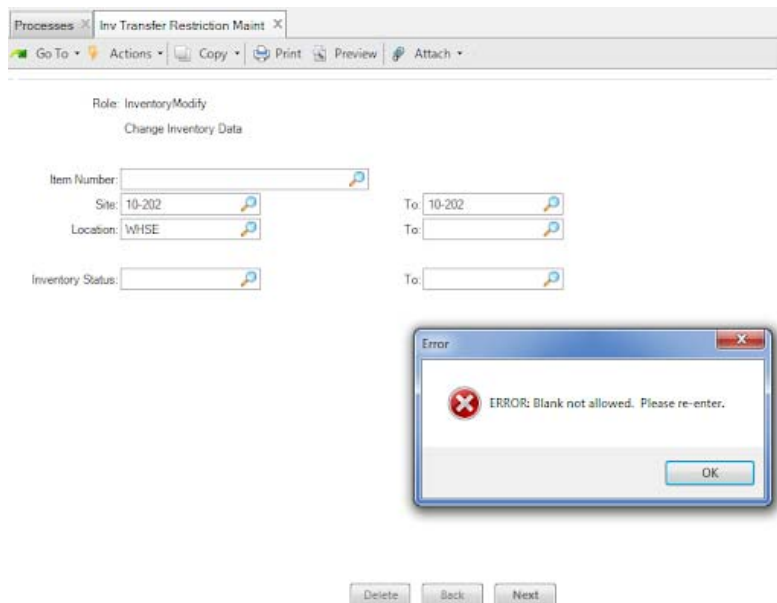

Minimum Data Required

N/A

Field Information

Field Name	Comments
tt...	
Item	<p>Input/Lookup/scan of item number.</p> <p>Lookup Name: Item Number</p> <p>Auto-display: No</p> <p>Look-up Query Rules:</p> <p>Lookup Fields: Item Number (Sort 1 Ascending)</p> <p>Validation: For the Advanced Putaway Version, add validation to check for Gen Code setup for user site/log-in. Present error message, "Generalized Code Not Defined,"</p>
Description	Displays the description of the input/scanned item.
Loc Zone	The default location type this inventory should be received into per Item Site / Item Master, QAD reserved field <code>pti_site_loc</code> .
UM	Displays the unit of measure of the input/scanned item.
Loc From	<p>The prompting and behavior of this field is different for each of the 3 inventory transfer flavors.</p> <p>Validation:</p> <ul style="list-style-type: none"> • Location cannot be same as Loc From. • Location is valid for user/site. <p>Lookup Name: All locations for item</p> <p>Auto-display: No</p> <p>Default Selected Values: Location</p> <p>Look-up Query Rules:</p> <ul style="list-style-type: none"> • Locations per the user log-in site. • Find/display first Non-Zero balance inventory locations per selected item number. • Note: Displays the location one time even though multiple <code>ld_dets</code> may exist. • Note: Location type should not be an input. <p>Lookup Fields:</p> <ul style="list-style-type: none"> • Location (Sort 1 Ascending) • QOH (->>, >>>9.9) • Created (Sort 2 Ascending) • Zone: The Location Type field in Location Maintenance. Used to define the Zone of the location. • Loc Stat
Lot/Serial From	Only applicable if inventory in the From Location has lots. Otherwise user is not prompted.
Reference From	Only applicable if inventory in the From Location has lots. Otherwise user is not prompted. Field not mandatory if no Reference is tied to the Lot/Serial #
Qty	<p>Input quantity to transfer.</p> <p>Validation: QTY is available to transfer, user cannot transfer more than available to transfer.</p> <div style="text-align: center;">  <p>ERROR: Quantity available in site location for lot/serial 40. Please re-enter.</p> </div>

Field Name	Comments
Loc To <i>(Data entry field)</i>	Enter/Select location to transfer item to. Validation: <ul style="list-style-type: none"> • Location cannot be same as Loc From. • Location is valid for user/site. The following look-ups can be called: <ul style="list-style-type: none"> • <i>Non-Zone Logic.</i> If Zone Storage Location (pti_det.pti_site_loc) = “blank” per item, then use Current Item Inventory look-up. • <i>Zone Logic.</i> If Zone Storage Location (pti_det.pti_site_loc) = “non-blank” per item, then use Putaway look-up. Non-Zone Logic Lookup Name: Current Item Inventory Auto-display: Yes Default Selected Values: Location Look-up Query Rules: <ul style="list-style-type: none"> • Find/display Non-Zero balance inventory locations per selected item number. • Do not display locations of selected Location From. • Do not display location more than once. Consolidate the inventory quantities if multiple lot records exist. • Do not default Loc To value if selected from look-up. Look-up Fields: <ul style="list-style-type: none"> • Location (Sort 2 Ascending) • QOH (->>, >>>9.9) • Created (Sort 1 Ascending) • Zone (pti_site_loc) • Loc Stat Basic Zone Logic Lookup Name: Putaway Locations (original version) Auto-display: Yes Default Selected Values: Location Look-up Query Rules: <ul style="list-style-type: none"> • Find/display Non-Zero balance inventory locations per selected item number where Location Type (loc_mstr.loc_type) = Zone Storage Location (pti_det.pti_site_loc). • Do not display locations of selected Location From. • Do not display location more than once (consolidate the inventory quantities if multiple lot records exist). • Find/display inventory locations with Location Type (loc_mstr.loc_type) = to Zone Storage Location (pti_det.pti_site_loc) per item site master where Zero balance, including locations where an ld_det record does not exist. • Do not default Loc To value if selected from look-up. Design Note: This browse is built using a procedure dcintrxr.p
Loc Zone	Per the selected Loc To value, display putaway(zone) per location maintenance location type loc_mstr.loc_type.
Review Before Commit <i>(Data entry field)</i>	Any input entered will complete the transaction. If data is incorrect, user should F4 back to correct it.

Troubleshooting

Issue/Error	Root/Solution
	<p>Per Inv Transfer Restriction Maintenance, user ROLE does not have permission to transfer inventory.</p> <ul style="list-style-type: none"> • See Inv Restriction Maintenance for settings. • See Role Permissions to see associated roles of users. • See “Setup Considerations” on page 26.
<p>In Component Pick-Transfer, after a component is picked, the transfer fails and displays message MFG-361 “Inventory status is not defined.”</p>	<p>We can have a blank status code defined, or we can have a default event on the ldstatus field to default from locFromStatus (same as in inventory transfer by lot). This will require some testing, too.</p>

Internal Item Label

Print an internal item label.

Transaction Technical

DC Menu	DC Menu Name	DC Transaction Technical Name	Production Order .NET Menu Action
1.1.3	Inventory	Internal Item Label	NA

Limitations / Exceptions

No label template provided.

Minimum System Setup

Label Printing Services must be installed.

Minimum Data Required

N/A

Transaction Flow Chart

Fig. 2.10
Internal Item Label

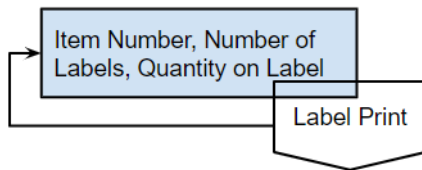

Field Information

Field Name	Comments
tt....- Item Label	
Site	Defaults from user log-in Values passed to LPS: Yes
WO ID (Hidden)	Passed from Linked production transaction Values passed to LPS: Yes
^Item (Data entry field)	Input item number Validate: Item is valid Values passed to LPS: Yes
Description	Display
Nbr of Lbl (Data entry field)	Input number of labels to print Values passed to LPS: Yes
Quantity on Label (Data entry field)	Input number of Items on Label Values passed to LPS: Yes
Call LPS (Hidden)	EventID: InternallItem Send Values: Site, Item Number, Nbr of Lbls, WO ID <ul style="list-style-type: none"> • lblstdxr.p createLPSWorkFileRecord, deleteLPSWorkFileRecord Values passed to LPS: Yes

Packaging

Pack Create by Pack Code

Create package ID (label) before receiving items/lots/serial inventory into it. Receive against discrete and scheduled orders.

Transaction Technical

DC Menu	DC Menu Name	DC Transaction Technical Name	Production Order .NET Menu Action
1.3.1	Packaging	Pack Create by Pack Code	Trans: Pack Create By Pack Code App: Pack Create by Pack Code (3.17.2, papacr01.p)

Limitations / Exceptions

N/A

Minimum System Setup

- Label Format Maintenance
- Test Printer

Minimum Data Required

N/A

Transaction Flow Chart

Fig. 2.11
Pack Create by Pack Code

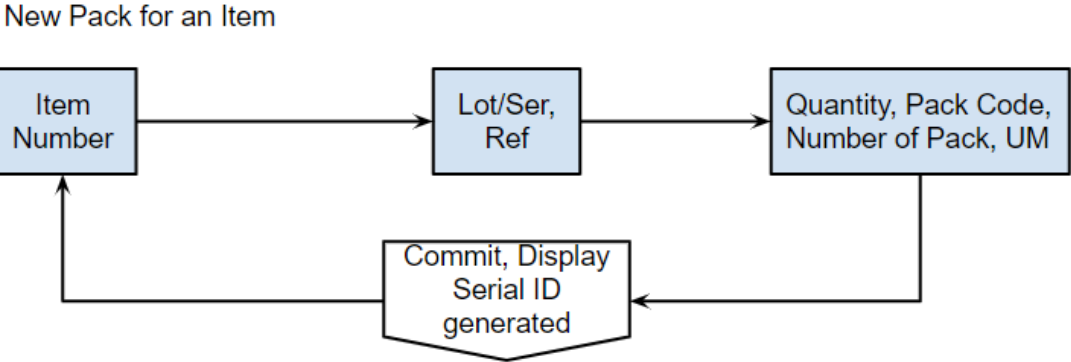



Field Information

Field Name	Comments
ttHeader - Pack Create by Pack Code	
Item <i>(Data entry field)</i>	Input/scan/look up Item to be added to Pack. Look-up Name: Auto-display: Default Selected Values: Look-up Query Rules: Display valid Items Look-up Fields: <ul style="list-style-type: none"> • Item Number • Description

Field Name	Comments
Lot/Ser <i>(Data entry field)</i>	Input/scan/look up Lot/Ser (Display only when non-blank value is entered). No validation required. Look-up Name: Auto-display: Default Selected Values: Look-up Query Rules: Display all Lot/Ser records of item selected in LoginSite. Look-up Fields: <ul style="list-style-type: none"> • Lot/Serial • Ref • Location • Qty OH • Status • Expiry Date
Ref <i>(Data entry field)</i>	Input/scan/look up Ref (Display only when non-blank value is entered). No validation required.
Quantity <i>(Data entry field)</i>	Input Quantity to add to Pack (Default to 1). Validation: Negative not allowed
Pack Code <i>(Data entry field)</i>	Input/look up Pack Code. Look-up Name: Auto-display: Default Selected Values: Look-up Query Rules: Display valid Pack Codes. Look-up Fields: <ul style="list-style-type: none"> • Pack Code • Description
Number of Pack <i>(Data entry field)</i>	Input Number of Packs to be created (Default to 1).
UM <i>(Data entry field)</i>	Input UM (Default to EA). Validation: UM entered must belong to either Item entered or Pack Code entered.

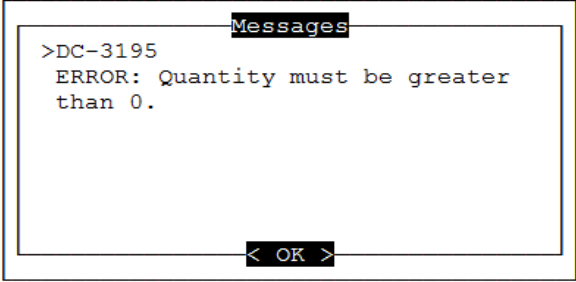
Troubleshooting

Issue/Error	Root/Solution
<p>Pack Build</p>  <p>F4-Back F10-Abort</p>	<p>User cannot enter negative number or 0.</p>
 <p>F4-Back F12-Abort</p>	<p>Setup Label format maintenance.</p>

Pack Build by Item

Build a new pack from serialized or non-serialized loose inventory. Add to a pack of non-serialized items from non-serialized loose inventory. Create/add Item, Lots, or Serialized inventory to a pack.

Transaction Technical

DC Menu	DC Menu Name	DC Transaction Technical Name	Production Order .NET Menu Action
1.3.2	Packaging	Pack Build - Item	Trans: Pack Build - Item App: Pack Build (3.17.3, papabd.p)

Limitations / Exceptions

- Does not support more than one Serialized Item in a pack.
- Does not support adding Serialized inventory.

Minimum System Setup

Label Format Maintenance

Minimum Data Required

N/A

Transaction Flow Chart

Fig. 2.12
Pack Build by Item

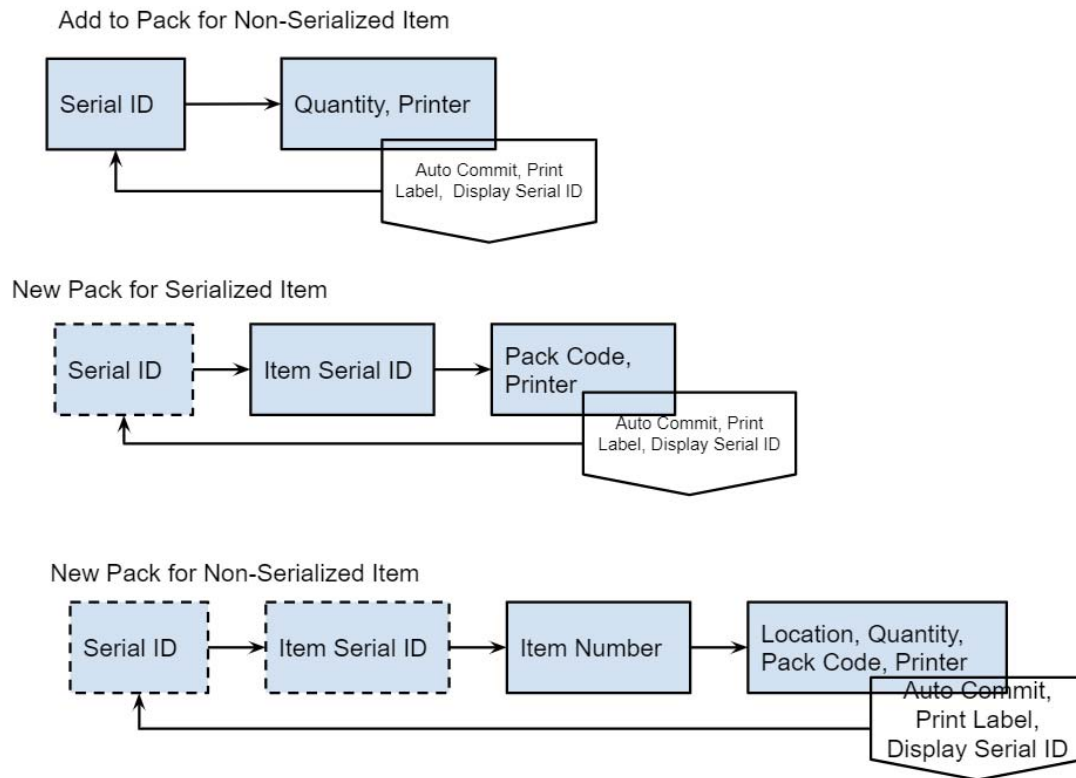

Field Information

Field Name	Comments
ttHeader - Pack Build by Item	
Serial ID <i>(Data entry field)</i>	<p>If adding item to Existing Pack: Input/scan/look up Serial ID of Pack to add inventory to.</p> <p>If adding item to New Pack: Leave field blank.</p> <p>Look-up Name:</p> <p>Auto-display:</p> <p>Default Selected Values:</p> <p>Look-up Query Rules:</p> <p>Look-up Fields:</p>

Field Name	Comments
Item Ser <i>(Data entry field)</i>	Enter blank to reach Item Nbr for building new Non-Serialized Pack. Not displayed in frame after blank entry.
Item Nbr <i>(Data entry field)</i>	If user selected existing serial ID, defaults from Serial ID.
Location	If adding item to Existing Pack: Enter location to pick items from. If adding item to New Pack: Enter location to build pack in.
Qty in Pk	If existing Pack, defaults from Serial ID.
Quantity <i>(Data entry field)</i>	Input Quantity to add to Pack.
Origin Address <i>(Data entry field)</i>	Prompt if creating new pack code. Please also add look-up same as .net.
Pack Code	If adding Item to Existing Pack: Defaults from Serial ID. If adding item to New Pack: Prompts for Pack Code.
Printer <i>(Data entry field)</i>	Input Printer to route Label to.

Troubleshooting

Issue/Error	Root/Solution
<p>Pack Build</p>  <p>F4-Back F10-Abort</p>	<p>User cannot enter negative number or 0.</p>
 <p>F4-Back F12-Abort</p>	<p>Setup Label format maintenance.</p>

Pack Build by LP

Create a new Master Pack and associate an existing child pack. Associate an existing child pack with an existing master pack. Add an existing package to a new or existing parent package. For example, you can add several boxes to a pallet.

Transaction Technical

DC Menu	DC Menu Name	DC Transaction Technical Name	Production Order .NET Menu Action
1.3.3	Packaging	Pack Build - LP	Trans: Pack Build - LP App: Pack Build (3.17.3, papabd.p)

Limitations / Exceptions

N/A

Minimum System Setup

- Label Format Maintenance
- Test Printer

Minimum Data Required

N/A

Transaction Flow Chart

Fig. 2.13
Pack Build by LP

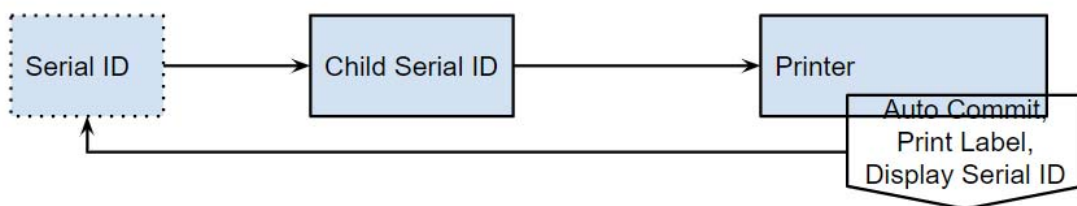

Field Information

Field Name	Comments
ttHeader -	
Master Pack ID (Data entry field)	Enter/Scan Master Pack to which you wish to add packs. If you do not have a Master Pack, leave blank to create a new Master Pack ID.
Location	Displays current location of Master Pack.

Field Name	Comments
Child Serial ID	Enter an active Pack or Item Serial ID to which you wish to add to the Master Pack. Validations: Validate the location type per the item in the pack = the location type of Child Packs already part of the Master pack ID structure. Note: All Child/Packs Items must have the same Location Type.
Item Number (Data entry field)	Displays Item Number of item in Child Pack if only a single item found.
Location	Displays Current Location of Child Pack.
Qty in Pack	Displays QTY in Child Pack.
No of Pk	Displays number of packs in scanned Child Pack.
Total Inv	Total qty of item in master pack.
Confirm (Data entry field)	Default = yes (used to allow user to view info before commit - we may want to hide this field when calling from a linked transaction).

Pack Merge

Merge Item or Pack Serial ID to Pack Serial ID. Merge packages together for packages with Active and Picked stages. Simplify transaction to focus on:

- Merge active pack to another active pack with same item/lot.
- Merge picked pack to another picked pack (without restrictions).

Transaction Technical

DC Menu	DC Menu Name	DC Transaction Technical Name	Production Order .NET Menu Action
1.3.4	Packaging	Pack Merge	Trans: Pack Merge App: Pack Merge (3.17.15, papamg.p)

Limitations / Exceptions

N/A

Minimum System Setup

N/A

Minimum Data Required

N/A

Transaction Flow Chart

Fig. 2.14
Pack Merge

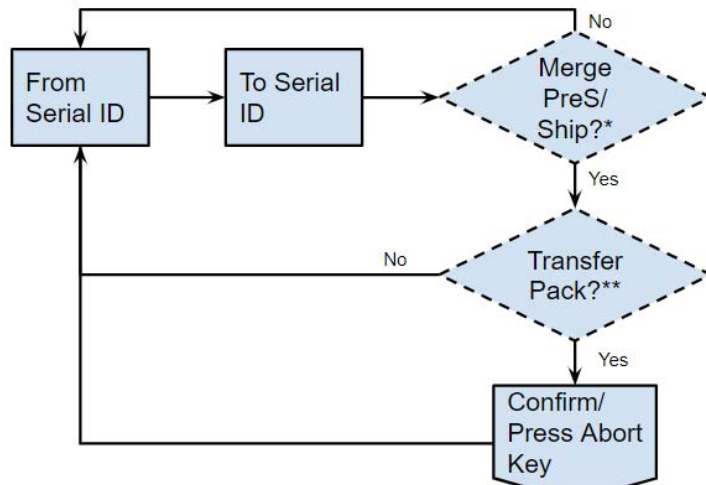

Set all optional prompts to Yes. If valid From/To serials entered, go to Confirm prompt.

*Conditional: User only prompted if From and To IDs belong to different Pres/Ship

**Conditional: User only prompted if From and To IDs are in different Site/Location

Field Information

Field Name	Comments
ttHeader - Pack Build by Item	
^From ID (Data entry field)	Input/Scan/Lookup Serial ID to merge From. Validation: Serial ID exists and has Stage = Active or Picked. Look-up Query Rules: Display Serial IDs with Stage = Picked and Active. Look-up Fields: <ul style="list-style-type: none"> • Serial ID • Item • Stage • Site • Location • PreS/Ship
Lot/Ref	Note: Conditional, only prompt for Lot and Reference if the item is lot controlled.
Stage	Defaulted
Location	Defaulted
PreS/Ship	Defaulted

Field Name	Comments
^To ID (Data entry field)	<p>Input/Scan/Lookup Serial ID to merge To.</p> <p>Validation: Serial ID exists and has Stage = Active or Picked. Does not equal serial ID entered as From Serial ID. If active stage, serial must have same item/lot as From Serial ID.</p> <p>Look-up Query Rules: Display Serial IDs with Stage equal to From ID Stage. If active stage, display serials with same item/lot. Do not display the serial entered in From ID.</p> <p>Conditional: If From ID is linked to a SO line, Display To ID linked to same SO line</p> <p>Look-up Fields:</p> <ul style="list-style-type: none"> • Serial ID • Item • Stage • Site • Location • PreS/Ship
Merge PreS/Ship? (Data entry field)	<p>Field #3 Merge PreS/Ship?</p> <p>Display: N/A (alert box)</p> <p>Validate: Logical input- yes or no.</p> <p>Note: Conditional message user receives if From/To Serial IDs are on different Pre-Shippers or Shippers.</p>
Stage	Defaulted
Location	Defaulted
PreS/Ship	Defaulted
Transfer Pack? (Data entry field)	<p>Validate: Logical input- yes or no.</p> <p>Note: Conditional message user receives if From/To Serial IDs are in different Site/Location.</p>

Pack Remove

Remove Serialized and non-serialized items from a pack. Remove and transfer items or child packs from a master pack.

Transaction Technical

DC Menu	DC Menu Name	DC Transaction Technical Name	Production Order .NET Menu Action
1.3.5	Packaging	Pack Remove	Trans: Pack Remove App: Pack Remove (3.17.5, paparm.p)

Limitations / Exceptions

Remove non-serialized items from a pack where items/lots are different.

Minimum System Setup

N/A

Minimum Data Required

N/A

Transaction Flow Chart

Fig. 2.15
Pack Remove

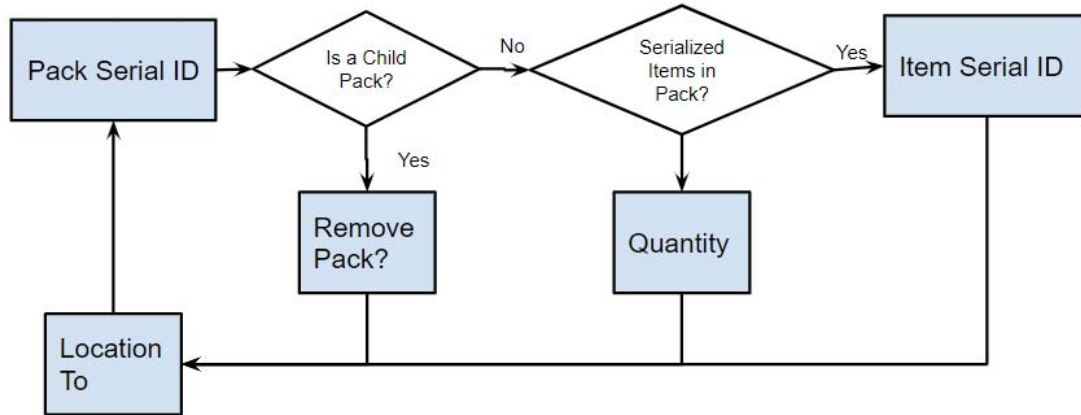

Field Information

Field Name	Comments
FRAME 1: Pack Remove Non-Serialized	
ttHeader - dummyParentSerial, ttParentData	
Serial ID (Data entry field)	Input/scan/look up Pack Serial ID. Validation: Pack serial exists and stage = Active. Process flow notes: <ul style="list-style-type: none"> • If Serial entered contains a serialized item, then go to field #3 Item Serial ID. • If Serial entered contains a non-serialized item, then go to field #2 Quantity. Lookup: Lookup includes active unit pack records only and not assembly packs or individual serialized items (Serial ID, Item Number, Qty in Pack, Pack Code, Stage). Query Rules: <ul style="list-style-type: none"> • Display all Serial IDs at Site = Login • Serial ID = Active Look-up Fields: <ul style="list-style-type: none"> • Serial ID (sort 1st ascending) • Item Number • Qty in Pack • Pack Code • Stage
Stage	Defaults from Pack Serial ID.
Item Nbr	Defaults from Pack Serial ID.
Desc	Default Item Desc.
Qty in Pk	Defaults from Pack Serial ID.
Lot/Ser	Default lot.
Ref	Default Ref.
Location	Default pack Location.
Exp Date	Default Item Expiry Date.

Field Name	Comments
Pack Code	Defaults from Pack Serial ID.
Quantity <i>(Data entry field)</i>	Input Quantity being removed from Pack. Database updated after Quantity is entered. Validation: Greater than 0 and less than/equal to Qty in Pack.
Confirm <i>(Data entry field)</i>	User enters Yes to Confirm, No to abort. Note: Default value = No
FRAME 2: Pack Remove Serialized	
ttHeader - dummyParentSerial, ttParentData	
Serial ID <i>(Data entry field)</i>	Input/Scan pack serial ID. Validation: Item serial exists in the selected pack serial.
Stage	Defaults from Pack Serial ID.
Item Nbr	Defaults from Pack Serial ID.
Qty in Pk	Defaults from Pack Serial ID.
Pack Code	Defaults from Pack Serial ID.
Item Serial ID <i>(Data entry field)</i>	Input/scan/look up Item Serial ID being removed from Pack. Database updated after Quantity is entered.

Pack Commission

Build a pack of non-serialized loose items. Activate an inactive serial ID, providing the ability for users to transact against it.

Transaction Technical

DC Menu	DC Menu Name	DC Transaction Technical Name	Production Order .NET Menu Action
1.3.6	Packaging	Pack Commission	Trans: Pack Commission App: Pack Commission (3.17.4, papacm.p)

Limitations / Exceptions

Does not support serialized loose items.

Minimum System Setup

See Packing Structure Maintenance (13.14.4) and Item Packaging Maintenance (13.14.7) for packaging setup.

Minimum Data Required

N/A

Transaction Flow Chart

Fig. 2.16
Pack Commission

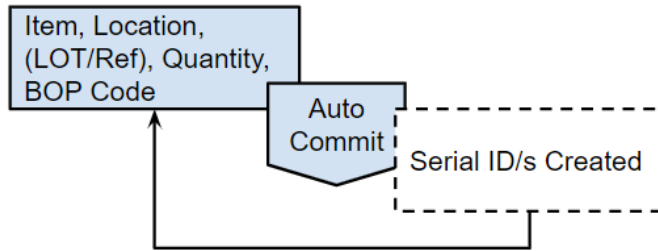

Field Information

Field Name	Comments
FRAME 1: Pack Commission	
ttHeader - dummySerialId, dummyDisplaySerialId, ttPackInfo, ttPackConfiguration	
Item <i>(Data entry field)</i>	Input/scan/look up item.
Location <i>(Data entry field)</i>	Input/look up location user withdraws inventory from to create a pack.
Quantity <i>(Data entry field)</i>	Input quantity of item to be put in a pack.
BOP Code <i>(Data entry field)</i>	Input/look up BOP code of Item.
Serial ID	Serial ID of pack is generated and displayed to the user.

Troubleshooting

Issue/Error	Root/Solution
<p>Pack Commission</p> <div style="border: 1px solid black; padding: 5px; margin: 10px 0;"> <p style="text-align: center;">Messages</p> <pre>>DC-11255 ERROR: BOP Code does not exist.</pre> <p style="text-align: center;">< OK ></p> </div> <p>F2-Look F4-Back F10-Abort</p>	<p>User receives this message if the item being received is not linked to a BOP or incorrect BOP is entered. In Packaging Structure Maintenance (13.14.4) and Item Packaging Maintenance (13.14.7) the user can assign a BOP to an item.</p>

Pack Decommission

Decommission a Non-Serialized or Serialized Item Pack, preventing transaction processing against it.

Transaction Technical

DC Menu	DC Menu Name	DC Transaction Technical Name	Production Order .NET Menu Action
1.3.7	Packaging	Pack Decommission	Trans: Pack Decommission App: Pack Decommission (3.17.6, papadecm.p)

Limitations / Exceptions

Does not handle Packs with Stage \neq Active.

Minimum System Setup

See Packing Structure Maintenance (13.14.4) and Item Packaging Maintenance (13.14.7) for packaging setup.

Minimum Data Required

N/A

Transaction Flow Chart

Fig. 2.17
Pack Decommission

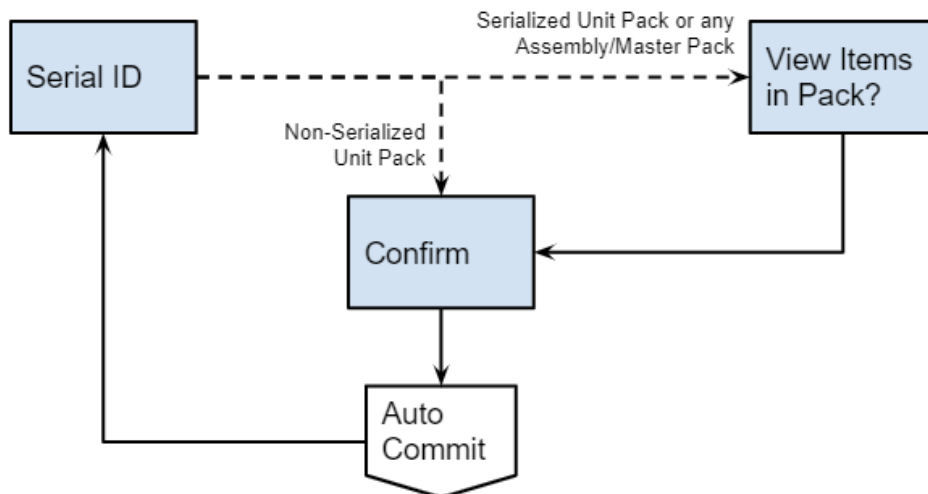

Field Information

Field Name	Comments
FRAME 1: Pack Decommission - Non-Serialized Unit Pack	
ttHeader - ttParentData	
Serial ID <i>(Data entry field)</i>	Input/scan/look up Serial ID to Decommission.
Item Nbr	Defaults from Serial ID.
Qty in Pk	Defaults from Serial ID.
Pack Code	Defaults from Serial ID.
Confirm <i>(Data entry field)</i>	Enter to Confirm.
FRAME 2: Pack Decommission - Serialized Unit Pack or any Assembly/Master Pack	
ttHeader - ttParentData	
Serial ID <i>(Data entry field)</i>	Input/scan/look up Serial ID to Decommission.
Pack Code	Defaults from Serial ID.
View Items in Pack? <i>(Data entry field)</i>	F2-Look to view Items, Descriptions, and Qty in Pk for Aggregated Unit Packs.
Confirm <i>(Data entry field)</i>	Enter to Confirm.

Troubleshooting

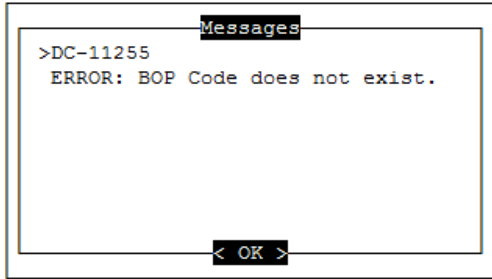
Issue/Error	Root/Solution
<p>Pack Commission</p>  <p>F2-Look F4-Back F10-Abort</p>	<p>User receives this message if the item being received is not linked to a BOP or incorrect BOP is entered. In Packaging Structure Maintenance (13.14.4) and Item Packaging Maintenance (13.14.7) the user can assign a BOP to an item.</p>

Pack Split

Split a package into multiple packages.

Transaction Technical

DC Menu	DC Menu Name	DC Transaction Technical Name	Production Order .NET Menu Action
1.3.8	Packaging	Pack Decommission	Trans: Pack Split App: Pack Split (3.17.16, papasp.p)

Limitations / Exceptions

This transaction is only configured to split unit-level serial IDs. It does not support use cases where users split child serial IDs from a master pallet to a different master pallet (existing or autogenerated). Contact QAD Services if this use case is required.

Minimum System Setup

N/A

Minimum Data Required

N/A

Transaction Flow Chart

Fig. 2.18
Pack Split

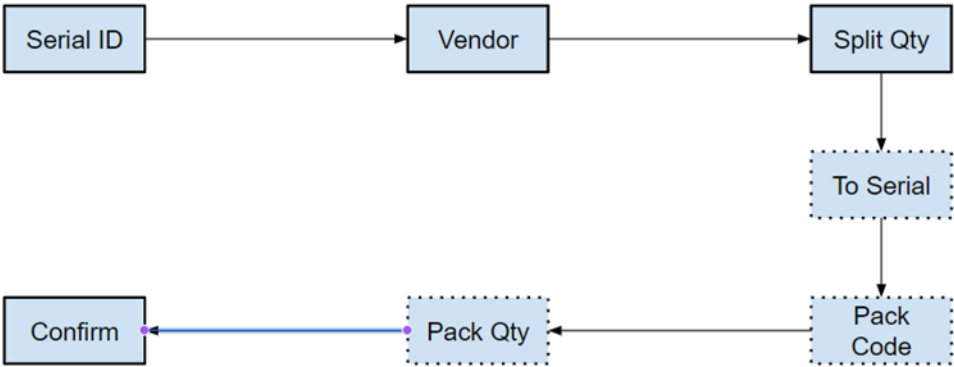

Field Information

Field Name	Comments
ttPackSplit	
Serial ID <i>(Data entry field)</i>	Input/scan/look up Serial ID to Split. Validation: <ul style="list-style-type: none"> • Blank not allowed • Serial ID exists • Serial ID stage is not Active • Serial ID is phantom = no • Check Serial ID is not Item serial ID • Validate Serial is unit pack • Serial ID site should be same as LoginSite Lookup Name: SerialID Auto Lookup: No Lookup Field: <ul style="list-style-type: none"> • Serial ID • Part • Pack Code • Serial Qty Available • Lot/Serial
Vendor <i>(Data entry field)</i>	Input/Scan/Look up Vendor (supplier) Validation: <ul style="list-style-type: none"> • Blank not allowed • Supplier should exist Lookup Name: Vendor Auto Lookup: No Lookup Field: <ul style="list-style-type: none"> • Vendor • Serial ID • Part • Serial Qty Available • Location
Part	Serial Item
Part Desc	Serial Item Description
Serial Location	Serial Location
Serial Lot/Serial	Lot/Serial value for Serial ID
Serial Quantity	Serial Quantity available
Split Quantity <i>(Data entry field)</i>	Input/Scan Validation: <ul style="list-style-type: none"> • Greater than zero • Cannot be greater than available qty in serial

Field Name	Comments
To Serial (Data entry field)	Input/scan/look up Serial ID to move split qty to. Look-up Name: SerialID Auto Look-up: No Look-up Field: <ul style="list-style-type: none"> • Serial ID • Part • Pack Code • Serial Qty Available • Lot/Serial
Pack Code (Data entry field)	Input/scan/look up Pack Code to create Serial. This field is prompted when To Serial is blank Validation: <ul style="list-style-type: none"> • Blank not allowed • Valid Pack Code • Must be same as From Serial Look-up Name: Pack Code Auto Look-up: No Look-up Field: <ul style="list-style-type: none"> • Pack Code • Description • UM
Pack Quantity (Data entry field)	Input/Scan Validation: Greater than zero
Confirm (Data entry field)	Confirm all entered data is correct before processing Pack Split.

Test Printer Setup

To avoid transaction error message, set up Test Printer. See the technical document details for this.

1 36.13.16.1.1 Label Printer Connection Maint

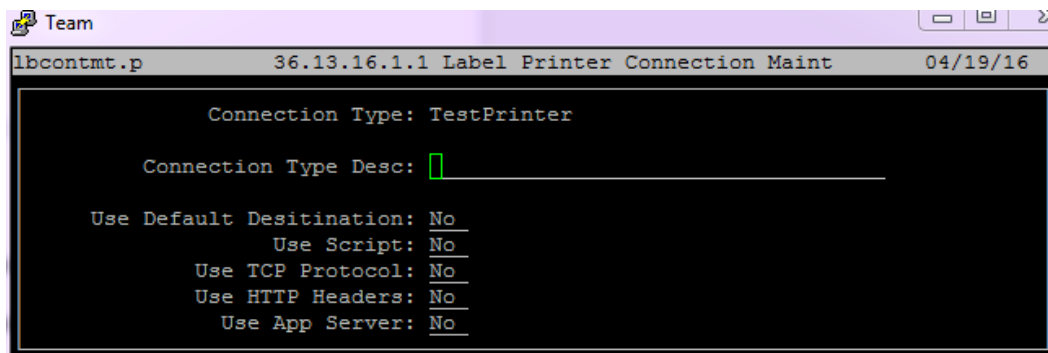

2 36.13.16.1.2 Label Printer Syntax Type Maint

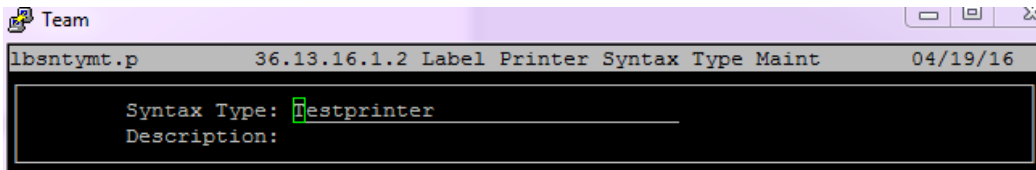

3 36.13.16.1.3 Printer Model Maintenance

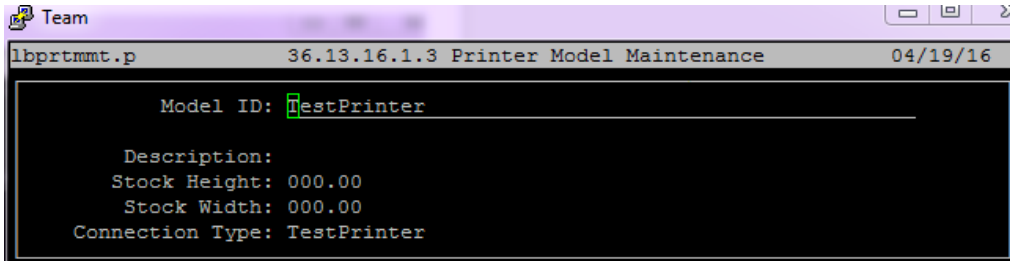

4 36.13.16.1.4 Print Queue Maintenance

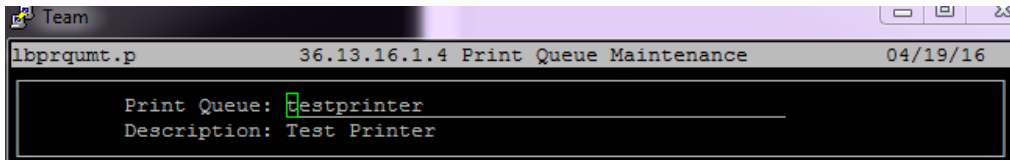

5 36.13.16.1.5 Label Printer Maintenance

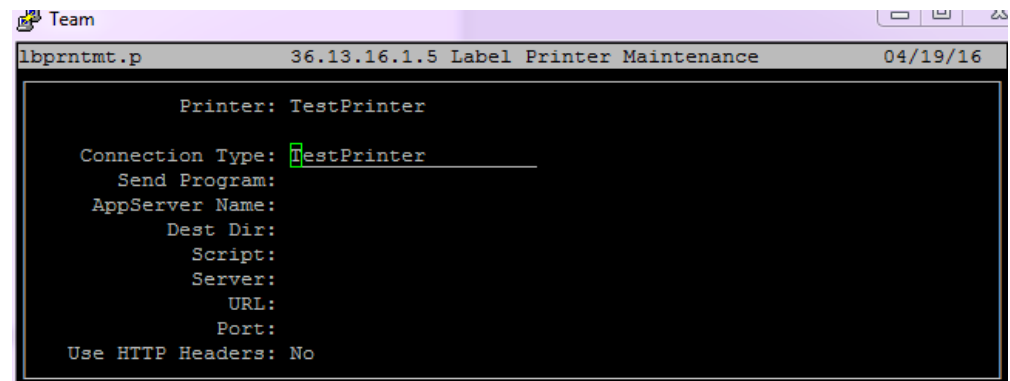
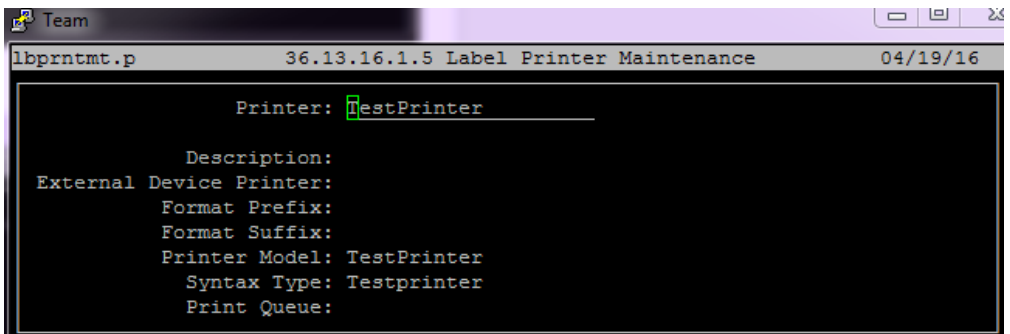

6 Save file try.pas on Application server (usually in home directory):

7 File try.pas is loaded to Google Drive. 36.13.16.1.7 Label Template Maintenance

```

Printer Syntax Type: Testprinter
Template Name: test1
Copy: No

Stock Description:
Stock Type:
Stock Height: 000.00
Stock Width: 000.00
Variable Separator: |
Pattern Separator:
Template File Name: /users/nmp/try.pas
File Mod Date: 12/10/15 File Mod Time: 12:37 A File Size: 3347

Data Contents
*FORMAT,~tt-MpLpDetail.LabelFormatID~
CUST_PART_1,~tt-MpLpDetail.CustPart_1~
CUST_PART_10,~tt-MpLpDetail.CustPart_10~
CUST_PART_2,~tt-MpLpDetail.CustPart_2~
CUST_PART_3,~tt-MpLpDetail.CustPart_3~
CUST_PART_4,~tt-MpLpDetail.CustPart_4~

```

8 36.13.16.1.9 Label Format Maintenance

```

Label Format: Lb1
Active: Yes

Label Desc: test
Track: No
Delete Labels before month:
Generate Files: No
Tokens: No
File Prefix:
File Suffix:
Copies: 1
Dataset:
Version:
Pause Between Label Generation(ms): 0

Printer Syntax Type: Testprinter
Merge Program:
Label Map:
Label Template: test1

Token Name:
Dataset Field Name:

```

Label Format Setup

Note A template file and a dataset from a customer environment was imported to a private environment for solving this issue.

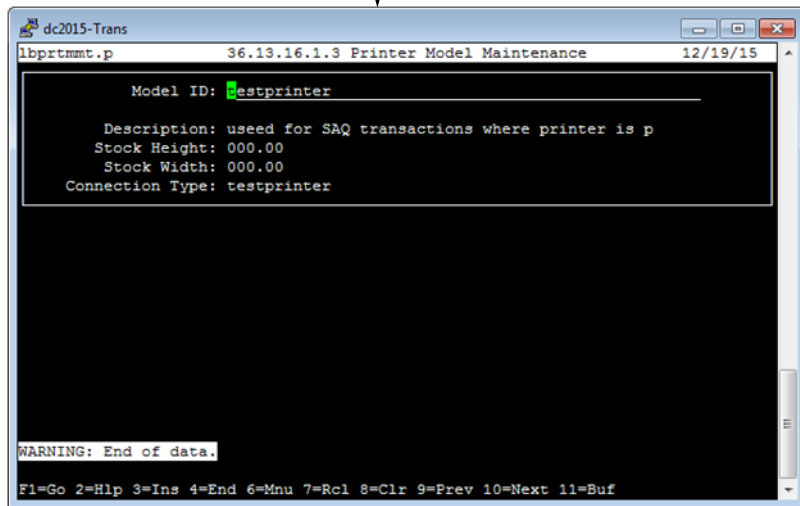
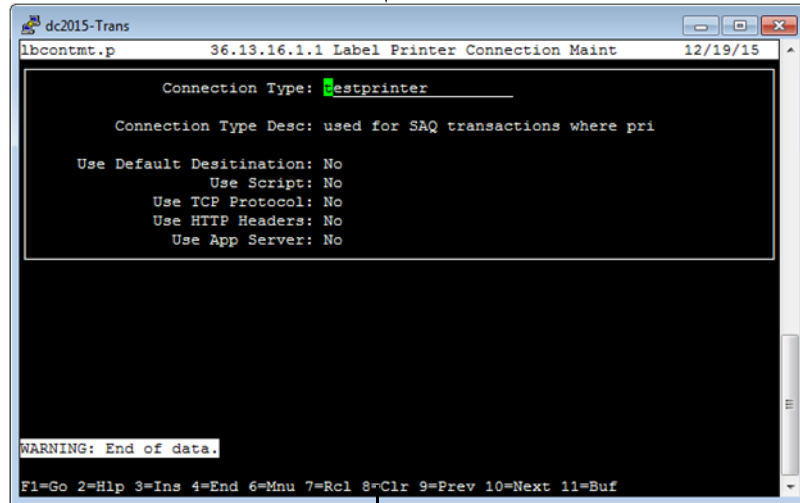
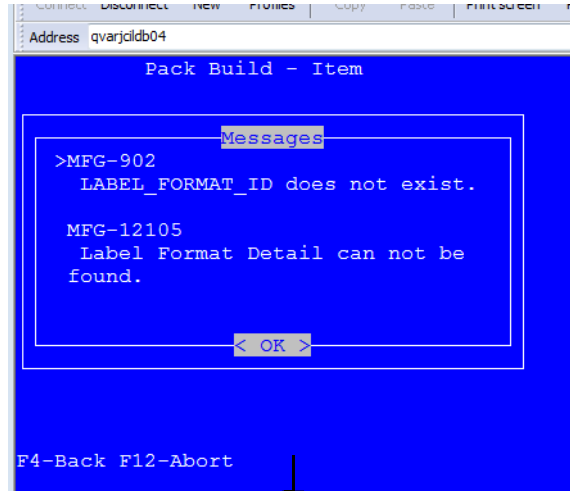

```
dc2015-Trans
lblprntmt.p 36.13.16.1.5 Label Printer Maintenance 12/19/15

Printer: testPrinter

Description: Dumy test printer
External Device Printer: Test
Format Prefix:
Format Suffix:
Printer Model: FileDrop
Syntax Type: PASS File
Print Queue:

WARNING: End of data.

F1=Go 2=Hlp 3=Ins 4=End 6=Mnu 7=Rcl 8=Clr 9=Prev 10=Next 11=Buf
```

```
dc2015-Trans
lblbtpmt.p 36.13.16.1.7 Label Template Maintenance 12/19/15

Printer Syntax Type: PASS File
Template Name: nmptry Copy:

Stock Description:
Stock Type:
Stock Height: 000.00 Stock Width: 000.00
Variable Separator: ~
Pattern Separator:
Template File Name: /users/nmp/try.pas
File Mod Date: 12/10/15 File Mod Time: 12:37 A File Size: 3347

Data Contents
*FORMAT,~tt-MpLpDetail.LabelFormatID~
CUST_PART_1,~tt-MpLpDetail.CustPart_1~
CUST_PART_10,~tt-MpLpDetail.CustPart_10~
CUST_PART_2,~tt-MpLpDetail.CustPart_2~
CUST_PART_3,~tt-MpLpDetail.CustPart_3~
CUST_PART_4,~tt-MpLpDetail.CustPart_4~

WARNING: End of data.

F1=Go 2=Hlp 3=Ins 4=End 6=Mnu 7=Rcl 8=Clr 9=Prev 10=Next 11=Buf
```

```
dc2015-Trans
lblbfmmt.p 36.13.16.1.9 Label Format Maintenance 12/19/15

Label Format: testprinter Active: Yes

Label Desc: desc test
Track: Yes Delete Labels before month:
Generate Files: Yes Tokens: No
File Prefix: kit_bom File Suffix: pas Copies: 1
Dataset: dsKit_bom Version: 1
Pause Between Label Generation (m/s): 0

Printer Syntax Type:
Merge Program:
Label Map:
Label Template:

Token Name:
Dataset Field Name:

WARNING: End of data.

F1=Go 2=Hlp 3=Ins 4=End 6=Mnu 7=Rcl 8=Clr 9=Prev 10=Next 11=Buf
```

Inventory Adjustments

Recount - By Item/Lot

Cycle count non-serialized items (loose inventory stored in a location within a site). Perform recount for item.

Transaction Technical

DC Menu	DC Menu Name	DC Transaction Technical Name	Production Order .NET Menu Action
1.7.1	Packaging	Recount - Item	Trans: Inventory Adjustment Entry - Recount Item App: Inventory Adjustment Entry (3.13.2, icccaj.p)

DC Menu	DC Menu Name	DC Transaction Technical Name	Production Order .NET Menu Action
1.7.2	Packaging	Recount - Lot	Trans: Inventory Adjustment Entry - Recount Lot App: Inventory Adjustment Entry (3.13.2, icccaj.p)

Limitations / Exceptions

- Recount - Item and lot transaction can be configured to perform an Initial Count.
- Currently not configured for serialized items or locations that have items in a pack.
- Users should have an entry for every Lot in each Location. If no inventory exists there, enter 0.

Minimum System Setup

See Inventory Control (3.24) for tolerance settings.

Minimum Data Required

N/A

Transaction Flow Chart

Fig. 2.19
Recount Item/Lot

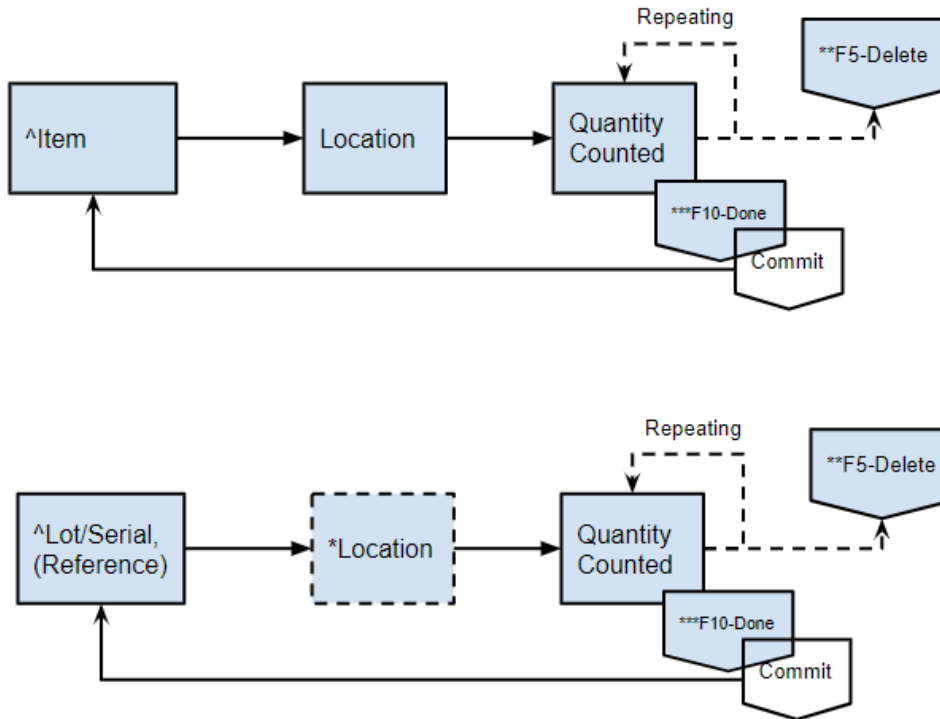

- *Location only prompted if Lot number is found in more than one location
- **F5-Delete exists to reset the Total Qty to 0 in case of an entry mistake
- ***F10-Done prompts question about Cycle Count being complete. User entering Yes indicates the count is complete for all lots in the item/location combination

Field Information

Field Name	Comments
FRAME 1: Pack Decommission - Non-Serialized Unit Pack	
ttHeader - ttParentData	
^Item/Lot <i>(Data entry field)</i>	Scan/Enter Item/Lot from the look-up. Note: User must enter a Quantity Counted for each Lot in the look-up. If Lot has no quantity left, user may enter 0.
Reference (Conditional) <i>(Data entry field)</i>	Conditional: Only applicable if inventory in the Location has lots. Otherwise user is not prompted. Field not mandatory if no Reference is tied to the Lot/Serial number.
Location (Conditional) <i>(Data entry field)</i>	Conditional: Input/scan/look up Location to cycle count Lot in. User is only prompted with Location if the lot exists in more than one Location.
Item	Item number of input/scanned lot defaulted.

Field Name	Comments
Description	Description of item defaulted from input/scanned Lot.
Site	Site defaulted from initial log-in.
Location	Redisplayed or defaulted from single lot record.
QOH	Displays Quantity on Hand at Location. See Location field for additional information on defaulted value.
Total Qty	Running total of Quantity Counted.
Last Qty	Most recent Quantity Counted input.
Quantity Counted <i>(Data entry field)</i>	Input quantity counted of item. Quantity Counted will continue to prompt until user enters F10-Done. This initiates processing and commits transaction to database.

Troubleshooting

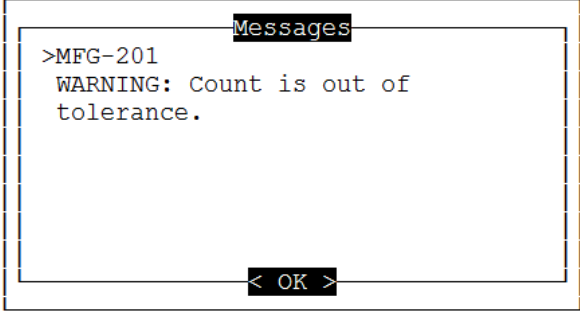
Issue/Error	Root/Solution
<p>Cycle Count Initial</p> 	<p>Per Inventory Control, inventory classes have established tolerances. Any Cycle Count Initial that falls outside of the tolerance will result in this message.</p> <p>See Inventory Control for settings.</p> <p>Inventory level will not change from Cycle Count Initial when count is out of tolerance.</p> <p>If true count is out of tolerance, must be updated from Cycle Count Recount.</p> <p>If count is inside tolerance, the transaction will process and the quantity will update. No message will be displayed if processed quantity is different than the original inventory quantity.</p>

Issues Unplanned

Perform unplanned issues for item and/or lot.

Transaction Technical

DC Menu	DC Menu Name	DC Transaction Technical Name	Production Order .NET Menu Action
1.7.4	Packaging	Issues - Unplanned	Trans: Issues - Unplanned App: Issues - Unplanned (3.7, icunis.p)

Limitations / Exceptions

- Does not support serialized items.
- Only supports Loose Inventory Transactions.

Minimum System Setup

N/A

Minimum Data Required

N/A

Transaction Flow Chart

Fig. 2.20
Issues Unplanned

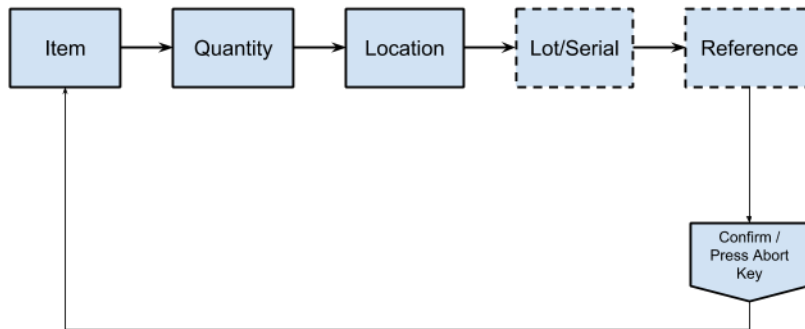

Field Information

Field Name	Comments
tt...	
Item Number (Data entry field)	Input/scan value. Validation: Item number should exist in Item Master. Lookup Fields: <ul style="list-style-type: none"> • Item • Description Lookup Rules: Items should be displayed as per LoginSite.
Description	Displays the description of input/scanned item.
UM	Display the UM for the entered Item.
Quantity (Data entry field)	Scan and display the quantity for the Item. Validation: Quantity should be greater than 0.
^Location (Data entry field)	Inventory location of input/scanned item number. Look-up Fields: <ul style="list-style-type: none"> • Loc • Description • Loc Status • Created Look-up rules: <ul style="list-style-type: none"> • Display locations where the inventory is present for the item and site. • Date Created reflects the date on which the item was received into the location.
Lot/Serial	Only applicable if inventory in the Location has lots. Otherwise user is not prompted.
Reference	Only applicable if inventory in the Location has lots and its reference field is not blank. Otherwise user is not prompted. Field not mandatory if no Reference is tied to the Lot/Serial #.

Field Name	Comments
WO ID	Prompt this field but do not validate.
Confirm / Press Abort Key <i>(Data entry field)</i>	Prompt this field to the user. Only Yes value is allowed and process the transaction.

Receipts Unplanned

Perform unplanned receipts for item and/or lot.

Transaction Technical

DC Menu	DC Menu Name	DC Transaction Technical Name	Production Order .NET Menu Action
1.7.5	Packaging	Receipts - Unplanned	Trans: Receipts - Unplanned App: Receipts - Unplanned (3.9, icunrc.p)

Limitations / Exceptions

- Does not support serialized items.
- Only supports Loose Inventory Transactions.

Minimum System Setup

N/A

Minimum Data Required

N/A

Transaction Flow Chart

Fig. 2.21
Receipts Unplanned

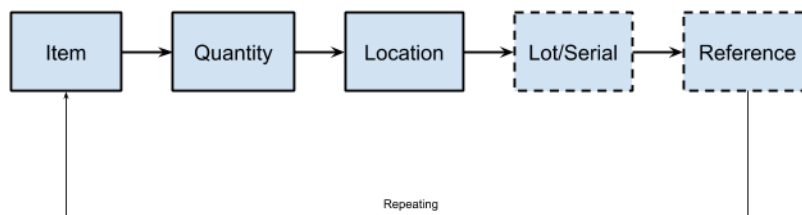

Field Information

Field Name	Comments
tt...	
Item Number (Data entry field)	Input/scan value. Validation: Item number should exist in Item Master. Look-up Fields: <ul style="list-style-type: none"> • Item • Description Look-up Rules: Items should be displayed as per LoginSite.
Description	Displays the description of input/scanned item
UM	Display the UM for the entered Item.
Quantity (Data entry field)	Scan and display the quantity for the Item. Validation: Quantity should be greater than 0.
^Location (Data entry field)	Inventory location of input/scanned item number. Look-up Fields: <ul style="list-style-type: none"> • Loc • Description • Loc Status • Created Look-up rules: <ul style="list-style-type: none"> • Display locations where the inventory is present for the item and site. • Date Created reflects the date on which the item was received into the location.
Lot/Serial	Only applicable if inventory in the Location has lots. Otherwise user is not prompted.
Reference	Only applicable if inventory in the Location has lots and its reference field is not blank. Otherwise user is not prompted. Field not mandatory if no Reference is tied to the Lot/Serial #.

Tag Count Entry - Pack

Update quantity on hand. Record and compare actual counts for an item with the system quantity on hand.

Transaction Technical

DC Menu	DC Menu Name	DC Transaction Technical Name	Production Order .NET Menu Action
1.7.7	Packaging	Tag Count Entry - Pack	Trans: Tag Count Entry - LP App: Pack Tag Count Entry (3.16.3.3, paptcc.p) Linked Trans: Tag Recount Entry linked

Limitations / Exceptions

N/A

Minimum System Setup

N/A

Minimum Data Required

Inventory balances are not changed until the Inventory Balance Update is run.

Transaction Flow Chart

Fig. 2.22
Tag Count Entry - Pack

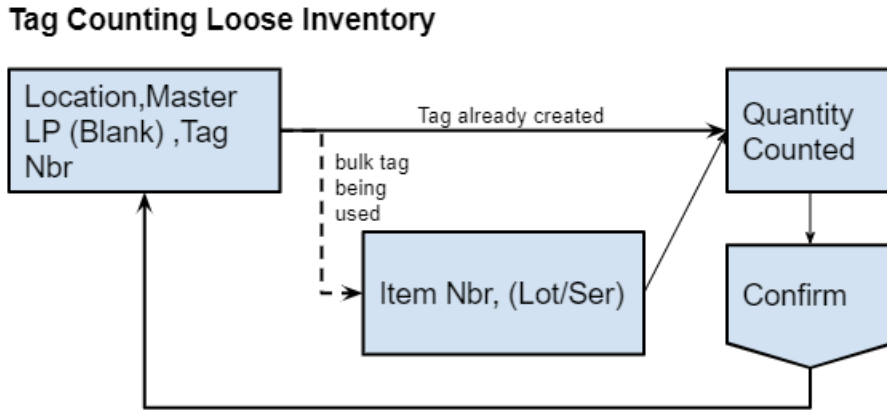

Field Information

Field Name	Comments
ttHeader - Physical Inventory Count (Loose Inventory)	
Location <i>(Data entry field)</i>	Input/scan/Lookup location. *****Recount Flow***** Display
Master Pk <i>(Data entry field)</i>	Blank Entered. *****Recount Flow***** Display
Tag Nbr <i>(Data entry field)</i>	Input/Scan/Lookup Inventory Tag Number. *****Recount Flow***** Validation: Tag is already counted.
Item Nbr (Conditional) <i>(Data entry field)</i>	Conditional: Input/scan/look up Item Number if Tag is being created Bulk Tag. Display Item Number if Tag is already created. *****Recount Flow***** Display
Desc	Display Item Description.
Lot (Conditional) <i>(Data entry field)</i>	Conditional: Input Inventory Lot Number is Tag is being created Bulk Tag. Display if Item is Lot Controlled and Tag is already created. *****Recount Flow***** Display

Field Name	Comments
Quantity Counted (Data entry field)	Input Quantity Counted.
Confirm (Data entry field)	Enter yes to confirm or no to return.
tt...- Physical Inventory Count (Master pack with child Serial IDs)	
Location (Data entry field)	Input/scan/Lookup if Tag is being created. *****Recount Flow***** Display
Master Pk (Data entry field)	Default master Pack Serial ID *****Recount Flow***** Display
Tag Nbr (Data entry field)	Input/Scan/Lookup Inventory Tag Number *****Recount Flow***** Validation: Tag is already counted
Item Nbr	Display
Desc	Display Item Description.
Lot	Display
Quantity Counted (Data entry field)	Input Quantity Counted. If Quantity counted is the same as system quantity proceed to confirm field. If quantity counted is different than system quantity, proceed to Child Pk field.
Confirm (Data entry field)	Enter yes to confirm or no to return.
Child Pk (Data entry field)	Input/scan/look up Child Serial ID. Look-up contains all packs on master pack. Place an asterisk next to each pack that has been counted.
Quantity Counted (Data entry field)	Input Quantity Counted.
Confirm (Data entry field)	Enter yes to confirm or no to return.
Finished Counting Child Packs (Data entry field)	Enter yes to complete tag count or no to loop back to Child Pk field.
tt...Physical Inventory Count (Master pack with NO child Serial IDs)	
Location (Data entry field)	Input/scan/Lookup location. *****Recount Flow***** Display
Serial ID (Conditional) (Data entry field)	Conditional: Input/scan serial ID if using a bulk tag. Display Serial ID if tag is already created. *****Recount Flow***** Display
Tag Nbr (Data entry field)	Input/Scan/Lookup Tag Number. *****Recount Flow***** Validation: Tag is already counted

Field Name	Comments
Item Nbr (Conditional) <i>(Data entry field)</i>	Conditional: Input/scan/look up Item Number if Tag is being created. Display Item Number if Tag is already created. *****Recount Flow***** Display
Desc	Display Item Description.
Lot (Conditional) <i>(Data entry field)</i>	Conditional: Input Inventory Lot Number if Tag is being created. Display if Item is Lot Controlled and Tag is already created. *****Recount Flow***** Display
Quantity Counted <i>(Data entry field)</i>	Input Quantity Counted.
Confirm <i>(Data entry field)</i>	Enter yes to confirm or no to return.

Tag Recount Entry - Pack

Count non-serialized items in a pack. Perform recount for item.

Transaction Technical

DC Menu	DC Menu Name	DC Transaction Technical Name	Production Order .NET Menu Action
1.7.8	Packaging	Tag Recount Entry - Pack	Trans: Tag Recount Entry - LP App: Pack Tag Recount Entry (3.16.3.4, paptrc.p) Linked Trans: Tag Recount Entry linked

Limitations / Exceptions

Initial Tag Count Entry must be done for user to utilize Tag Recount Entry transaction.

Minimum System Setup

N/A

Minimum Data Required

Inventory balances are not changed until the Inventory Balance Update is run.

Bar Code Format

- QR 2D codes and Linear 1D Codes are multi-field and single field in some cases.
- The separator needs to be configurable. Currently, it is “:”. Ascii code 58 (to verify).
- The format is <Item>:<Lot/Ser>:<Ref>:<Quantity>.

Transaction Flow Chart

Fig. 2.23
Tag Recount Entry - Pack

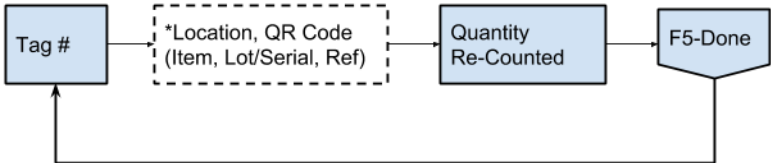

*Conditional fields only prompted if Tag type is Bulk (tag_mstr.tag_type = B)

Field Information

Field Name	Comments
ttHCycCntRes	
Tag <i>(Data entry field)</i>	Enter/Scan tag number. Validate: <ul style="list-style-type: none"> Tag number must exist. Tag is “active” (not void, not posted - tag_mstr.tag_void = No) and already counted. Tag count entry must have record. Initial tag date cannot be null. Query Rules: Display all tag records per location already counted. Look-up Fields: <ul style="list-style-type: none"> Item Description
Site	Site defaulted from initial log-in tag number. Validated against login site.
Location <i>(Conditional)</i>	Defaults per system generated tag number. User prompted for lot/serial location if this is a bulk tag. Validation Rules: Location must exist Query Rules: Display valid locations at Site = Log-in Look-up Fields: <ul style="list-style-type: none"> Location Description
Scan Barcode <i>(Conditional)</i>	Only prompts if bulk tag (type=B)
Item Number <i>(Conditional)</i>	Defaults per system-generated tag number. Retrieve from QRCode Item if this is a bulk tag. Validation Rules: Item must exist.
Lot/Serial <i>(Conditional)</i>	Defaults per system-generated tag number. Retrieve from QRCode Lot/Serial if this is a bulk tag. Validation Rules: Cannot be blank if Item is Lot/Serial = L in Item Master or Item-Site data.
Reference <i>(Conditional)</i>	Defaults per system-generated tag number. Retrieve from QRCode Ref if this is a bulk tag. Validation Rules: Ref can be blank.

Field Name	Comments
Description	Defaults from Item Number.
UOM	Defaults from Item Number.
ABC Cl	Defaults from Item Number.
QOH	Not displayed
Quantity Re-Counted (Data entry field)	Input quantity counted for Item/Location. Need to support at least Format “9,999,999.99” European (7 + 2 Digits).
Re-Count UM	Not displayed: Defaults from Item Master.
Re-Count Conv	Not displayed: Defaults to “1.0000”.
Re-Counted By	Not displayed: Defaults to user log-in.
Date Re-Counted	Not displayed: Defaults to current date (mandatory for API).
Remarks	Not displayed.: Defaults to blank.

Quality Release/Reject Label

Print an item/lot quality label, identifying status of the item, such as rejected or approved.

Transaction Technical

DC Menu	DC Menu Name	DC Transaction Technical Name	Production Order .NET Menu Action
1.1.2	Inventory	Quality Release/Reject Label	NA

Limitations / Exceptions

- The label template is not provided.
- If more than 1 lot record is found in system, the user is prompted for the Item Number and From Location; otherwise, these values will default when user scans/enters the lot number.

Minimum System Setup

Label Printing Services must be installed.

Minimum Data Required

N/A

Transaction Flow Chart

Fig. 2.24
Quality Release/Reject Label

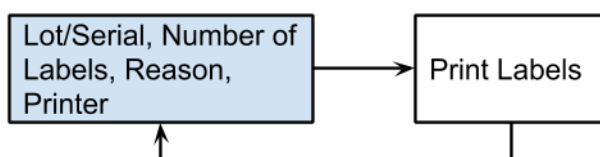

Field Information

Field Name	Comments
ttReleaseRejectLabel	
Lot/Serial <i>(Data entry field)</i>	Input/scan/look up Lot/Serial number Look-up Name: Auto-display: Default Selected Values: Look-up Query Rules: Display Lot/Serial where Qty on Hand > 0 Look-up Fields: <ul style="list-style-type: none"> • Lot/Serial • Item Number • Qty on Hand • Expiry Date • Status
Item	Defaults from Lot/Serial number. User may be prompted if Lot/Serial exists in more than one location
Location	Defaults from Lot/Serial number. User may be prompted if Lot/Serial exists in more than one location
Desc	Defaults from Item
Status	Defaults from Lot/Serial number
Label Type	Defaults from Lot/Serial number
Num Labels <i>(Data entry field)</i>	Input number of labels to print
Reason <i>(Data entry field)</i>	Input/look up Select New or Reprint
Printer <i>(Data entry field)</i>	Input/look up Printer to use

Inbound Transactions

This chapter includes detailed technical information for the Automation Solutions: Data Collection Inbound transactions.

Introduction 66

Purchase Receipts 66

Introduction

This chapter covers the following transactions:

- PO Shipper Create by Pack
- Inbound Receipts
- Purchase Order Receipts
- Pending PO Shipper Unload
- DO Receipt by Pack
- Inbound Label Print
- Material Putaway

Purchase Receipts

PO Shipper Create by Pack

Create a Shipper with packaging units. This is applicable when ASNs are not received via EDI or you want to license plate incoming purchase receipts. Also allows you to modify an existing PO Shipper. Creates an LP for each Shipper Record.

Transaction Technical

DC Menu	DC Menu Name	DC Transaction Technical Name	Production Order .NET Menu Action
3.1.1	Purchase Receipts	PO Shipper Create by Pack	Trans: PO Shipper Maintenance by Pack App: PO Shipper Maintenance (5.13.14, rsshmt.p) <ul style="list-style-type: none"> • Calls linked transaction: Pack Create by PO Shipper (5.13.12.3, papocr.p)

Limitations / Exceptions

N/A

Minimum System Setup

N/A

Minimum Data Required

N/A

Field Information

Field Name	Comments
tt...	
Shipper ID (Data entry field)	Look-up Query Rules: Display Suppliers for pending PO Shippers per selected purchase order in prior field. Look-up Fields: <ul style="list-style-type: none"> • Ship-From (Sort ascending) • Shipper ID
PO Nbr (Data entry field)	Input/scan/look up Purchase Order Number. Blank is not allowed. Validate Ship-to = login site. Look-up Query Rules: Display Open Purchase Orders at Site = Login Look-up Fields: <ul style="list-style-type: none"> • Order • Date • Sch • Supplier
Pack Slip (Data entry field)	Enter packing slip number. (Do not default this value). Blank not allowed. Display off after Item field prompt.
^Item Number (Data entry field)	Prompt if Order is left blank. Provide list of Open POs per entered item
Desc	Display from Item Master.
Line, UM	Defaults first open PO Line. Defaults from Item Master.
PO UM	Defaults from Item Master.
Tot Qty Rec (Data entry field)	Input total quantity being received.
Location (Data entry field)	Default from Item Site Maint. Turn off display for Line and PO UM.
Lot/Ser (Data entry field)	Defaults if autolot. Enter lot number if it is not defaulted.
Supplier Lot (Data entry field)	Enter supplier lot number.
Confirm (Data entry field)	Yes or no
Print Item Labels? (Data entry field)	Enter yes to print item labels and proceed to printer field or no to not print the item labels and skip the printer field.
^Printer (Data entry field)	Enter label printer for items and validate. Default to dummyPrinter if Print Item Labels? = No.
ttLotSerialRefInfo - Order Detail	
PO Nbr	Redisplay
Qty Rec	Redisplay
Line	Redisplay
^Item	Redisplay
Desc	Redisplay
Lot/Ser	Redisplay

Field Name	Comments
Pack Code <i>(Data entry field)</i>	Default/Prompt (TBD)
Nbr of Pks <i>(Data entry field)</i>	Enter number of packs being received.
Pack Qty <i>(Data entry field)</i>	Enter the quantity on each pack. Default value to 1, do not display, do not allow user to update.
Confirm <i>(Data entry field)</i>	Enter Yes to Confirm or No to Abort.
Print Pack Label? <i>(Data entry field)</i>	Enter Yes to Print or No to not print pack labels.
^Printer <i>(Data entry field)</i>	Input/scan/lookup printer.
	Pop-up displays message 'X Serial IDs created ending at XXXXXXXX'
Linked Transaction - Pack Create by PO Shipper	
tt...	
Supplier	Defaulted from Transaction 1.
PO	Defaulted from Transaction 1.
Line	Defaulted from Transaction 1.
Lot #	Defaulted from Transaction 1.
Receipt Quantity	Defaulted from Transaction 1 Receipt QTY field.

Troubleshooting

Issue/Error	Root/Solution
<p>PO Shipper Maintenance</p> <pre> Open PO's by Site Order Date Schd Supplier ----- > P1010111 01/22/15 no QMI - USA D P1010111 01/22/15 no QMI - USA D mns1013 10/14/14 no QMI - USA D mns1013a 10/13/14 no QMI - USA D MPOTest 11/21/14 no QMI - USA D P1010002 05/06/13 no QMI - USA D P1010041 10/13/14 no QMI - USA D </pre> <p>^Purchase Order</p> <p>PO Shipper Maintenance</p> <pre> Item Number Qty Open Qty to Rec PO Line ----- > 50.0 2.0 P1010111 1 30.0 2.0 P1010111 2 50.0 3.0 P1010111 1 30.0 3.0 P1010111 2 </pre> <p>^Item Number</p>	<p>Purchase Order look-up duplicates PO number after partial receipt. Item Number look-up also displays duplicate PO number.</p>

Inbound Receipts

Inbound Receipts is a parent transaction that can receive all receipt types: Purchase Orders, Scheduled Orders, and Distribution Orders.

Transaction Technical

DC Menu	DC Menu Name	DC Transaction Technical Name	Production Order .NET Menu Action
3.1.2	Purchase Receipts	Inbound Receipts	Trans: Inbound Receipts Parent App: Calls linked transactions <ul style="list-style-type: none"> • Purchase Order Receipts (5.13.1, poporc.p) • Pending PO Shipper Unload (5.13.12.13) • DO Receipt By Pack (12.9.13 padorc.p)

Transaction Flow Chart

Fig. 3.1
Inbound Receipts

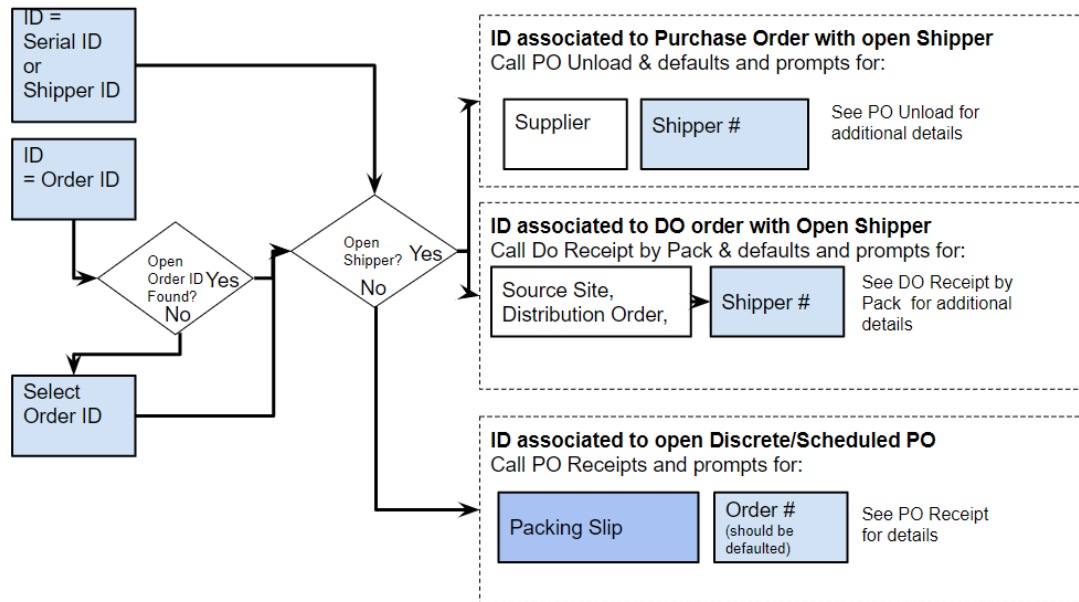

Field Information

Field Name	Comments
tt...	

Field Name	Comments
ID (Data entry field)	<p>If user scans a serial number, the system checks if serial is PO Unload or DO Unload.</p> <p>If user scans an order number, system determines if PO Unload or DO Unload.</p> <p>If user scans an item number, system displays list of open orders to select from.</p> <p>If system finds multiple matches of scanned value, system displays list of orders to select from.</p>
Orders (Data entry field)	<p>Conditionally prompt if ID is not found or multiple orders found for ID. If system finds multiple matches of scanned value, display list of orders to select from.</p> <p>Look-up Name: Inbound Open Orders</p> <p>Auto-display: No</p> <p>Default Selected Values: Order</p> <p>Auto-display: Yes</p> <p>Look-up Query Rules:</p> <p>Where Order Type = "F" Discrete</p> <ul style="list-style-type: none"> • and Order Ship-To (pod_det.pod_site) = "user log-in site" • and Order Status (po_mstr.po_stat) = "blank" <p>Where Order Type = "T" Scheduled</p> <ul style="list-style-type: none"> • and Order Ship-To (scx_ref.scx_shipto) = "user log-in site" • and Order Status start date (po_mstr.po_eff_strt) and end date (po_mstr.po_eff_to) <= current date <p>Where Order Type = "Distributed"</p> <ul style="list-style-type: none"> • and Order Ship-To (scx_ref.scx_shipto) = "user log-in site" <p>Look-up Fields:</p> <ul style="list-style-type: none"> • Order: Purchase / Scheduled Order # / Distribution Order • Date (Sort 1 Ascending): For discrete orders, where Order Due Date where oldest open order line due date. For scheduled orders, where (po_mstr.po_eff_strt) • Supplier: Supplier Name • Schd?: If order is Scheduled Order type = Yes • Order Type: Discrete, Scheduled, Distributed • Open Shippers?: If open shippers found for order, display "yes"

Purchase Order Receipts

Receive against discrete and scheduled orders. This transaction supports both discrete purchase order and supplier schedule receipts.

Transaction Technical

DC Menu	DC Menu Name	DC Transaction Technical Name	Production Order .NET Menu Action
3.1.2.2-1	Purchase Receipts	Linked from "Inbound Receipts Parent"	Trans: Purchase Order Receipts App: Purchase Order Receipts (5.13.1, poporc.p)

Bar Code Format

- Linear Codes 1D multi-field as well as single field.
- Prefixes used
- The separator needs to be configurable and its currently ":". Ascii code 58 (to verify).

- The format is: <Item>:<Lot/Ser>:<Ref>:<Quantity>.
- Label examples in the Labels Section.

Fig. 3.2
Purchase Order Receipts - Label Example



Limitations / Exceptions

- Process a single purchase order per packing slip.
- Does not support EAM PO receipts.
- DC does not support negative PO receipts by design.
- Not configured for regulatory and lot attributes.

Minimum System Setup

N/A

Minimum Data Required

Open discrete or scheduled order

Transaction Flow Chart

Fig. 3.3 Purchase Order Receipts

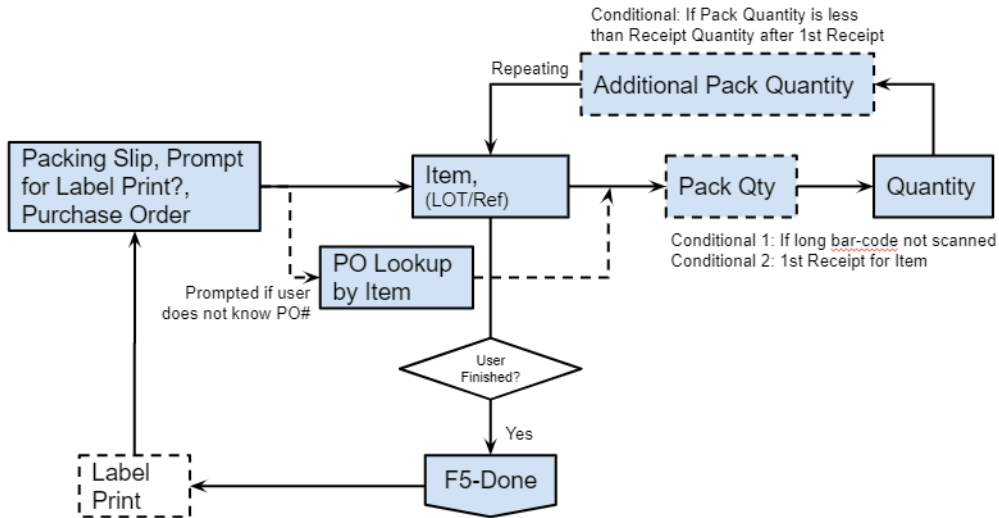

Field Information

Field Name	Comments
tt...	
Packing Slip <i>(Data entry field)</i>	Input/scan Packing Slip number
Print Labels? <i>(Data entry field)</i>	
Purchase Order/Long Bar Code <i>(Data entry field)</i>	Input/scan Packing Slip number Validations: Open PO Look-up Name: Purchase Order Auto-display: Yes Default Selected Values: Order Look-up Query Rules: Where Order Type = "F" Discrete <ul style="list-style-type: none"> • and Order Ship-To(<i>pod_det.pod_site</i>) = "user log-in site" • and Order Status(<i>po_mstr.po_stat</i>) = "blank" Where Order Type = "T" Scheduled <ul style="list-style-type: none"> • and Order Ship-To(<i>scx_ref.scx_shipto</i>) = "user log-in site" • and Order Status start date(<i>po_mstr.po_eff_strt</i>) and end date (<i>po_mstr.po_eff_to</i>) <= current date Look-up Fields: <ul style="list-style-type: none"> • Order - Purchase / Scheduled Order # • Date (Sort 1 Ascending) - For discrete orders, where Order Due Date where oldest open order line due date. For scheduled orders, where (<i>po_mstr.po_eff_strt</i>) • Supplier - Supplier Name • Schd? - If order is Scheduled Order type = Yes

Field Name	Comments
Item/Long Bar Code (Data entry field)	<p>Input/scan/lookup Item on Purchase Order</p> <p>Validations:</p> <ul style="list-style-type: none"> • If Long-Bar Code is scanned, Validate: Box (label) has not been scanned prior per the label (CTRL#) • If PO Receipts Status is active per item master, validate pt_mstr.pt_rctpo_status [DC-362 Status does not exist Item Receipt Status] <p>Look-up Name: PO Item</p> <p>Auto-display: Yes</p> <p>Default Selected Values: Item/Line</p> <p>Look-up Query Rules: Same as prior defined</p> <p>Look-up Fields:</p> <ul style="list-style-type: none"> • Order - Purchase / Scheduled Order # • Date (Sort 1 Ascending) • Supplier - Supplier Name • Schd? - If order is Scheduled Order type = Yes
Line	Defaults from PO
Lot	<p>Lot number will default if Auto-Lot is enabled.</p> <p>The lot will conditionally prompt if the item is defined as lot controlled.</p>
Receipt Status	<p>Hidden field</p> <p>The Location status is used. This is different from .NET UI where the receipt status is used.</p> <p>The following logic is used to get the receipt status/Inventory status in .NET UI:</p> <ol style="list-style-type: none"> 1. Check if 1.4.16 item site inventory data record is available for item and site. 2. If available then check if Active flag for PO Receipt status is set. If yes then use item-site inventory data record for PO Receipt Status. If not then move to next step. 3. Check if 1.4.1 item master records is available for item. 4. If available then check if Active flag for PO Receipt status is set. If yes then use Item Master record for PO Receipt Status. If not then move to next step. 5. Check inventory detail record (Id_Det) with domain site loc part lot ref. If record is available then use status from inventory detail record. If not available then move to next step. 6. Get status from location master. If location master not available then move to next step. 7. Get status from site.
Location	Defaults per PO Line
Packing Slip (Data entry field)	<p>Input Packing Slip Total Quantity. User is only prompted first time Item is selected.</p> <p>Conditional: If long-bar code is scanned per the Order or Item field, do not prompt for Packing Slip QTY.</p>
UM	Defaults from Item
Desc	Defaults from Item
Total Qty	Total quantity received for Item
Last Qty	Last quantity received for Item
Quantity (Data entry field)	<p>Input quantity received of Item per pack</p> <p>Validate (Custom):</p> <ul style="list-style-type: none"> • Validate against scheduled / discrete order due date per current date • Validate against scheduled order or discrete PO the QTY to receive
WO ID	<p>WO ID</p> <p>Conditional: Display WO ID if a WO ID exists for sub-contract order line.</p>

Field Name	Comments
Receipt Location	Default value from Purchase Order Line. Display the field. Conditional: Prompt for receipt location if no location found on PO.
Additional Pack Quantity	Conditional: If user responds “YES”, user inputs additional pack quantity if original Pack Quantity was insufficient.
	After user completes first item, receipt LOOP. Purpose: Prompt for the next item to scan, and redisplay the last item scanned.

Troubleshooting

Issue/Error	Root/Solution
<p>PO receipt - by PO PO Detail</p> <div style="border: 1px solid black; padding: 5px; margin: 10px 0;"> <p style="text-align: center;">Messages</p> <pre>>MFG-337 ERROR: Overshipment percentage exceeds 10. Please re-enter.</pre> <p style="text-align: center;">< OK ></p> </div> <p>F4-Back F5-Done F10-Abort</p>	<p>Per Purchasing Control (5.24)</p> <p>User not allowed to receive more than overshipment percentage. Site used in example has 10% limit.</p>

Pending PO Shipper Unload

Receive packs, validating against a pre-shipper.

Transaction Technical

DC Menu	DC Menu Name	DC Transaction Technical Name	Production Order .NET Menu Action
3.1.2.2-2	Purchase Receipts	Linked from “Inbound Receipts Parent”	Trans: Pending PO Shipper Unload by Pack App: Pending PO Shipper Unload (5.13.12.13)

Fig. 3.4
Pending PO Shipper Unload

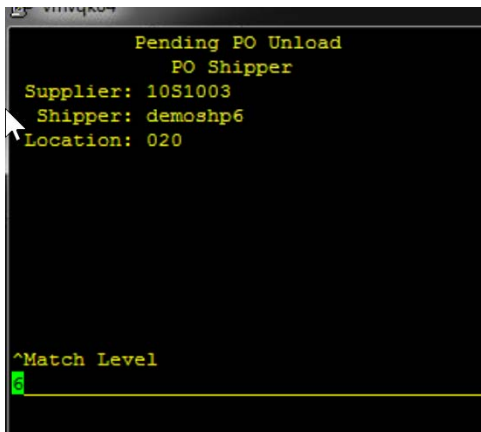

Limitations / Exceptions

- No Linked transactions are existing.
- No label printing functionality is included.
- Some limitations in API prevent using matching levels 1 and 7.
- 1D and 2D Barcodes are supported:
 - The matching level defaults from the Supplier.
 - The matching level must be selected by the user.
 - An API limitation requires users to define whether to confirm the shipper up front or during a later buffer.
 - In case there is no PO Shipper, we do not dynamically support this in Automation Solutions.

Minimum System Setup

See Packing Structure Maintenance (13.14.4) and Item Packaging Maintenance (13.14.7) for packaging setup.

Minimum Data Required

- PO Shipper already has PO Container setup.
- The Container ID associated with the PO Shipper will become serial ID at receiving.

Transaction Flow Chart

The Matching Level will determine the flows.

Fig. 3.5
Pending PO Shipper Unload

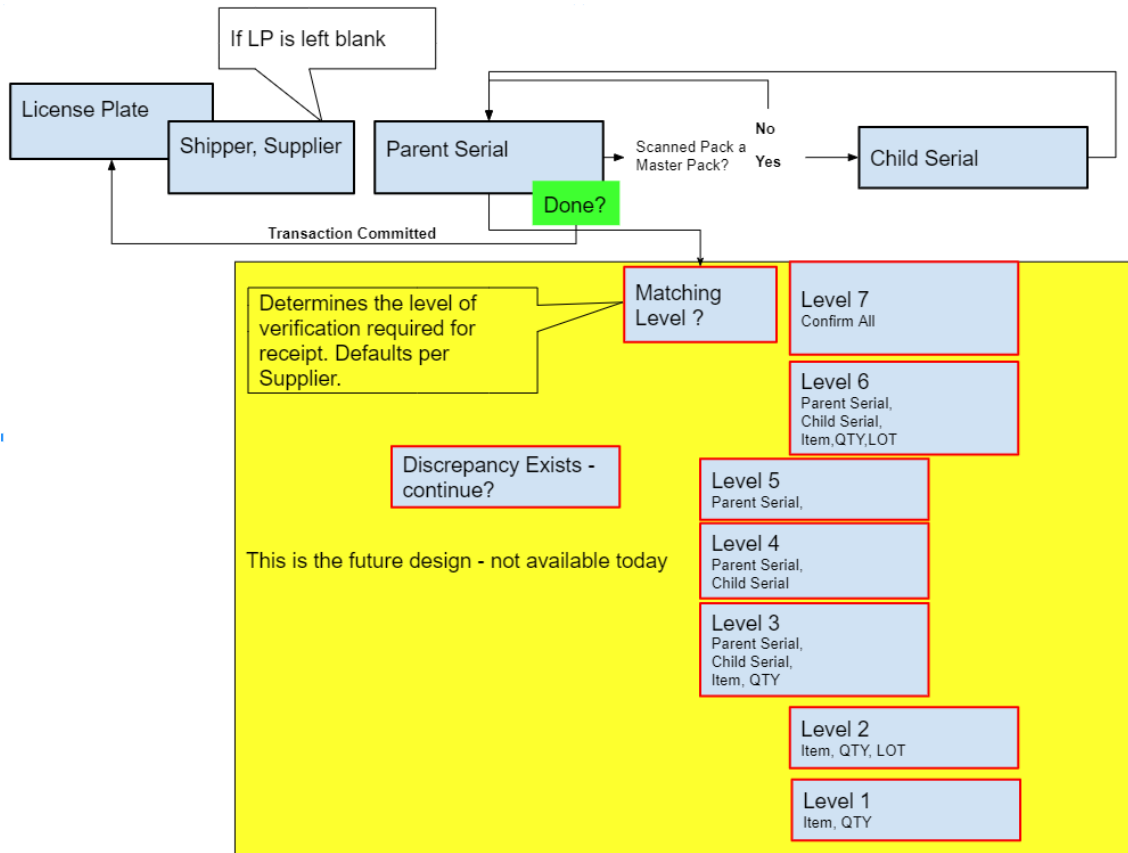

Matching Levels

Fig. 3.6
Pending PO Shipper Unload

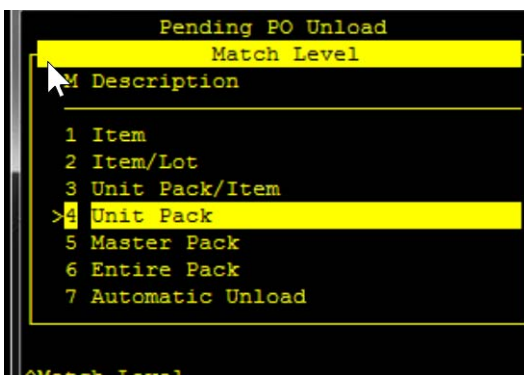

Note Match Level 7 (Automatic Unload) is equivalent to a Shipper Receipt. Displays the number of Shipper lines to receive.

Unload Option #	Field Prompt	Unload Options / Match Levels 6 - 1					
		6A / 6B Entire Pack	5A / 5B Master Pack	4 Unit Pack	3 Unit Pack/Item	2 Item/Lot	1 Item
Primary Use Cases							
6A	Shipper Parent Parent Pack Serial ID	If Pack Code multi-pack, prompt for child pack. Can leave blank (to create new pack)	If ID contains items in pack - ERROR	If ID contains items in pack - ERROR	If ID contains items in pack - ERROR	HIDE	HIDE
5A	Child Pack Serial ID	Can leave blank (to create new pack)	HIDE	ID must contain SINGLE Item in Pack	ID must contain SINGLE Item in Pack	HIDE	HIDE
2	Lot, Reference, Supplier Lot	Enter /Validate	Display	Display	Display	Enter / validate	HIDE
1	Item, QTY	Enter /validate	Display	Display	Enter /validate Enter	Enter / validate	
6	If Serial ID left blank: BOP Code	Default/Modify	HIDE	HIDE	HIDE	Default/ Modify	Default/ Modify
Unsupported Use Cases							
1B	Shipper Container						
2B	Shipper Sub- Containers						
	multi-items in SERIAL pack						
	multi-items in CONTAINER						
	Same item number on different PO lines						
	Same item on different POs						

Field Information

Field Name	Comments
tt...	
Scan LP (Data entry field)	<p>Scan LP to locate Shipper to receive against.</p> <p>Note: Look-up can be used to see the serials that have not yet been received. Turn off update of LP and turn off update and display of D LP.</p> <p>Validations:</p> <ul style="list-style-type: none"> • Blank not allowed. • LP should be attached to a PO Shipper. • LP should be for login site. • License Plate should be attached to same PO/shipper as “Scan LP”. • Shipper not previously confirmed: “Error, Shipper Previously Confirmed” • DC-5814: Selected shipper has invalid type.
Long Barcode	<p>Note: Consider this an example of what can be done. The logic has been left in the transaction, but turned off.</p> <p>Input/scan long barcode of Supplier Code and Shipper ID.</p> <p>Format: CUST 10S1002(Supplier Code) bwsJan19A(PO Shipper) CUST 10S1002 bwsJan19A</p>
PO Nbr	Defaults from first LP scan. If LP not provided, prompt for PO Nbr.
Shipper	Defaults from first LP scan. If LP not provided, prompt for PO Nbr.
Match Level	<p>Defaults per Match Level Maintenance definition per Supplier definition (Match Level Maintenance).</p> <p>Provides ability for user to change the match level, which determines the level of scan verification to perform in the transaction.</p>
Total Lines	
Total Qty	Default total quantity from all License Plates.
Parent Serial (Data entry field)	<p>Conditionally prompts per Matching Levels: 6,5,4,3.</p> <p>Scan LP to locate Shipper to receive against.</p> <p>Note: Look-up can be used to see which serials have not yet been received. Serials that have been received will be marked with an ‘ * ‘ and serials that have not been received will be marked with a blank space. This will not be a scan the first time through. Post process: verify serial has not already been scanned.</p> <p>If an LP is scanned more than once, the following error message will be displayed: “Serial ID has already been processed, do you wish to proceed?” If user enters No, return to License Plate field. If user enters Yes, proceed to total receipt complete field.</p>
Child Serial (Data entry field)	Conditionally prompts per Matching Levels: 6,4,3.
Item	<p>Default/Display value</p> <p>Conditionally prompts per Matching Levels: 6,2 (does not default value).</p>
LOT #	<p>Default/Display value</p> <p>Conditionally prompts per Matching Levels: 6,2.</p> <p>Conditionally prompts if item is LOT controlled.</p>
REF #	<p>Default/Display value</p> <p>Conditionally prompts per Matching Levels: 6,2 (does not default value).</p> <p>Conditionally prompts if item is LOT controlled.</p>

Field Name	Comments
Qty <i>(Data entry field)</i>	Default/Display value Conditionally prompts per Matching Levels: 6,3,2,1 (does not default value).
Location	Defaulted from Location: <ul style="list-style-type: none"> Scheduled Order Maintenance - pod_det.pod_loc We choose not to use PO Shipper location field: sr_wkfl.sr_loc
	Post process: If any LPs have not been entered, ask user to Receive with discrepancy? (Yes or No). If user enters Yes, receive the inventory. If user enters No, return to License Plate field.

Troubleshooting

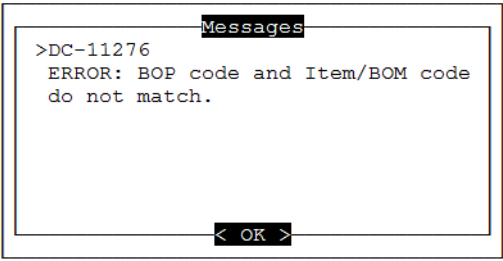
Issue/Error	Root/Solution
Pack Receipts By WO - Step 0 	User receives this message if the item being received is not linked to a BOP or incorrect BOP is entered. In Packaging Structure Maintenance (13.14.4) and Item Packaging Maintenance (13.14.7), the user can assign a BOP to an item.

DO Receipt by Pack

Receive Distribution Order by Pack. Perform negative receipt of Pack on Distribution Order.

Transaction Technical

DC Menu	DC Menu Name	DC Transaction Technical Name	Production Order .NET Menu Action
3.1.2.2-3	Purchase Receipts	Linked from "Inbound Receipts Parent"	Trans: DO Receipt By Pack App: DO Receipt By Pack (12.9.13 padorc.p)

Limitations / Exceptions

Configured to automatically decommission the pack upon receipt.

Minimum System Setup

N/A

Minimum Data Required

N/A

Transaction Flow Chart

Fig. 3.7
DO Receipt by Pack

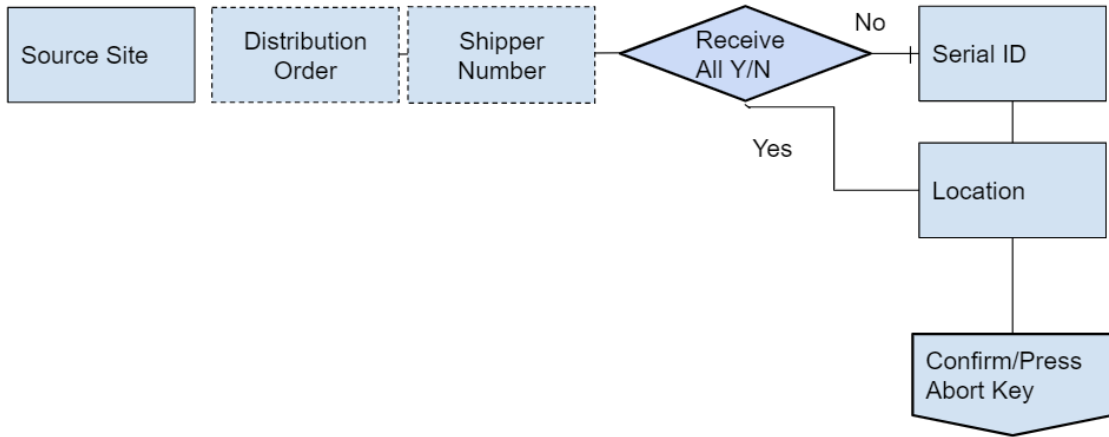

Field Information

Field Name	Comments
Pack Receipts by Production Line dttDistributedOrder, ttDistributedOrder, ttPickedSerial, ttPickedRequisition	
Src Site <i>(Data entry field)</i>	Input/scan/look up Source Site. (1) Field #1 Source Site Update enable Validations: <ul style="list-style-type: none"> • Site exists • Site is not the log-in site Look-up Query Rules: Display Sites ≠ Log-in Look-up Fields: <ul style="list-style-type: none"> • Site (1st ascending) • Description

Field Name	Comments
Order (Data entry field)	<p>Input/scan/look up Distribution Order Number.</p> <p>Allow the user to enter <blank> or a valid Order. When blank, prompt Serial field and Receive All flag should be set to no.</p> <p>Field #2 Distribution Order</p> <p>Display- Source</p> <p>Update enable</p> <p>Validations:</p> <ul style="list-style-type: none"> • Distribution Order exists/open • Ship-To for Distribution Order is the log-in site <p>Look-up Query Rules:</p> <ul style="list-style-type: none"> • Display Distribution Orders with Ship-To = Log-in • Display Serial ID stage = Active <p>Look-up Fields:</p> <ul style="list-style-type: none"> • Source (1st ascending) • Serial ID (2nd ascending) • Order • Ship-To
Use Shipment Information (Hidden)	Conditionally set this to Yes if the Distribution Order field is not blank.
Shipper Number (Hidden)	Shipment Number
Receive All? Y/N (optional) (Data entry field)	<p>Add new optional prompt once user enters an Order - 'Receive All? Y/N'.</p> <ul style="list-style-type: none"> • If N is selected, then proceed with the existing transaction flow. • If Y is selected, prepare to receive all open serial IDs on the Shipper/Order that are available for receiving.
Serial ID (Data entry field)	<p>Input/scan/look up Pack Serial ID.</p> <p>Prompt the user for this field before Corrcn. If the user entered <blank> in Order field, please display the Order once Serial ID is entered.</p> <p>Field #4 Serial ID</p> <p>Display- Source, Order, Corrcn</p> <p>Update enable</p> <p>Validations:</p> <ul style="list-style-type: none"> • Serial ID is open on the entered Distribution Order (not already received). • Serial ID is stage active. <p>Look-up Query Rules:</p> <ul style="list-style-type: none"> • Display Serial IDs on selected Distribution Order (Display Serial IDs for all Distribution Orders with Ship-To = Log-in). • Display Serial ID stage = Active <p>Look-up Fields:</p> <ul style="list-style-type: none"> • Item (1st ascending) • Quantity (2nd descending) • Serial ID • Pack Code
Item	Defaults from Pack Serial ID.
Qty in Pk	Defaults from Pack Serial ID.
Open Qty	Defaults from Pack Serial ID.

Field Name	Comments
Location (Data entry field)	<p>Input/scan/lookup receiving Location.</p> <p>Note: Location is only prompted when Correctn = No.</p> <p>Field #5 Location</p> <p>Display- Source, Order, Correctn, Item, Qty in Pk, Open Qty, Serial ID</p> <p>Update enable</p> <p>Validations: Location exists</p> <p>Look-up Query Rules: Display Locations at Site = Log-in</p> <p>Look-up Fields:</p> <ul style="list-style-type: none"> • Location (1st ascending) • Description • Status • Date Created
Receive/Press Abort Key (Data entry field)	<p>Enter to Confirm transaction or press F10-Abort to leave.</p> <p>If Confirmed, please Decommission and return to the Serial ID field.</p> <p>Prompt user - Receive / Press Abort Key.</p> <p>Display- Source, Order, Correctn, Item, Qty in Pk, Open Qty, Serial ID, Location</p> <p>Update enable</p> <p>Validations: <return> or Abort only</p> <p>Note: Removed Quantity to Receive prompt. User is required to receive the entire pack.</p> <p>Return to Serial ID field</p> <p>Scenario 2 - negative receipt (correction = yes)</p>
Other field settings	<ul style="list-style-type: none"> • Internal Setup Notes (comparison to .NET flow) • 'Site' = log-in site • Set Date = current date • Set Use Shipment Information = unchecked • Set Request Number = to the Request Number originating demand for the item on the Distribution Order • All other fields Update = no / Display = no

Inbound Label Print

Print/reprint inbound receipts label.

Transaction Technical

DC Menu	DC Menu Name	DC Transaction Technical Name	Production Order .NET Menu Action
3.1.4	Purchase Receipts	Inbound Label Print	Trans: PO Label Print App: NA

Limitations / Exceptions

A sample label.

Transaction Flow Chart

Fig. 3.8
PO Label Print

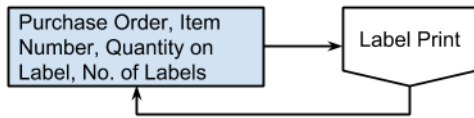

Field Information

Field Name	Comments
ttPOLabel, ttPODet, ttLblDet	
PO Nbr <i>(Data entry field)</i>	Input/scan/lookup Purchase Order number
PO Line	Defaults from PO Nbr and Item
Item <i>(Data entry field)</i>	Input/scan/lookup Item Number
Qty on Lbl <i>(Data entry field)</i>	Input Quantity of Item on label
No. Of Labels <i>(Data entry field)</i>	Input Number Of Labels

Material Putaway

Directs material handlers where to put away received materials.

Note For detailed transaction information, see “Production Item Putaway” on page 206

Transaction Technical

DC Menu	DC Menu Name	DC Transaction Technical Name	Production Order .NET Menu Action
3.1.4	Purchase Receipts	Material Putaway	Trans: Production Order Item Putaway App: Inventory Transfer with Lot/Serial Change (3.4.3, iclotr03.p)

Limitations / Exceptions

Requires implementation services to refine/develop putaway rules/logic. The putaway logic provided with this transaction is not supported and is used for reference only. For assistance on the putaway rule logic, please contact QAD Services.

Outbound Transactions

This chapter includes detailed technical information for the Automation Solutions: Data Collection Outbound transactions.

Introduction 86

Outbound Shipments 86

Shipment Modify 125

Outbound 134

Introduction

This chapter covers the following transactions:

- SO Bulk Pick - Transfer
- SO Pre-Shipper Create
- Pre-Shipper Pick
- Pre-Shipper Pack
- Sub Contract Container
- Sub Contract Shipper Pick
- Pre-Shipper Convert to Shipper
- Truck Load
- DO Shipper Confirm
- Move Pack between Shipper
- Pack Merge
- Shipper LP Weight Modify
- Shipper Labels
- Shipper Item Label
- License Plate Label

Outbound Shipments

SO Bulk Pick - Transfer

Use this transaction to transfer non-serialized loose inventory by item from a warehouse location to a shipping stage location. It directs users to pick and transfer materials from the warehouse to a packaging staging area, where users will later pick and package according to the pre-shipper requirements.

Transaction Technical

DC Menu	DC Menu Name	DC Transaction Technical Name	Production Order .NET Menu Action
7.1.1	Outbound Shipment	SO Bulk Pick - Transfer	Trans: Transfer With Lot/Erial Change - SO Bulk Pick App: Inventory Transfer (3.4.3, iclotr03.p)

Limitations / Exceptions

This transaction is provided for demonstration/conceptual purposes. No QAD Support provided. Please contact QAD Services for changes (picking logic) required for your implementation.

Minimum System Setup

Follow these steps if you are picking by ZONE:

Location Maintenance x

Go To Actions Copy Print Preview Attach

Site: 101 Kendallville
 Location: 10R1A1

Description: ROW 1 SECTION A LEVEL 1

Inventory Status: GOOD

Project:

Date Created: 7/5/2015

Permanent:

Type: R1

Single Item:

Single Lot/Reference:

Capacity: 0.0 UM:

Reserved Locations:

Using field = Zone

- 1 Define zones for items in Item Site Inventory Data Maintenance (1.4.16).
- 2 Zones to be associated to locations
 - This zone field is used for the Inventory Putaway Transaction to determine the locations matching the zone defined in Item Site Inventory Data Maintenance (1.4.16).
 - Zones are also assigned to locations for the outbound warehouse, which is required for the SO Bulk Pick transaction to work. The SO Bulk Pick transaction uses the zone assigned to a location to find the items to pick per the pre-shipper/shipper pick requirements.
- 3 GCM Setup

Field Name	Value	Comments	Group
loc_type	floor	Material stocked on the workflow.	SYSTEM
loc_type	R1	Zone R1	SYSTEM
loc_type	R5	Zone R5	SYSTEM
loc_type	stockrm	Materials stored in a stockroom	SYSTEM
loc_type	W1	Zone W1	SYSTEM
loc_type	warehse	Material stored in a warehouse	SYSTEM

- 4 Where Value is the “Inventory Status” specified in Location Maintenance. Inventory Status for the location should be “PBAY.” Otherwise, the location look-up may not work as expected.

```

mgcodemt.p          36.2.13 Generalized Codes Maintenance          03/01/16
-----
Generalized Codes
Field Name: SO BULKPICK STATUS
Value: PBAY

Comments:

Group: APP
    
```

Minimum Data Required

- Picklists
- Inventory to Pick

Transaction Flow Chart

Fig. 4.1
SO Bulk Pick - Transfer

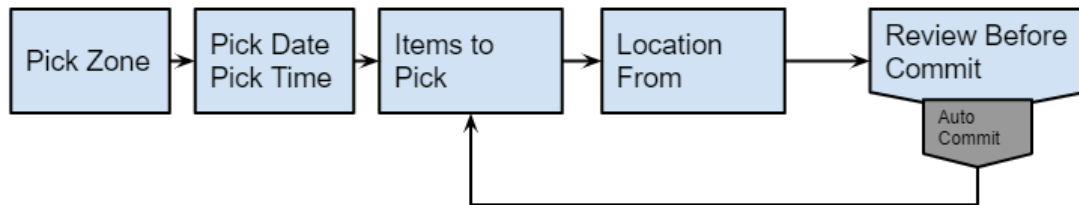

SO Bulk Pick Procedure Logic

This section explains the SO Bulk pick procedure logic.

For SO Item Lookup, the procedure name is createInvPartRec. This procedure will list items having requirements for picking.

- The procedure accepts a Zone value (maintained in loc_type). This zone can be single zone or pipe (|) separated list of zones.
- The procedure lists items that have quantity on hand for locations satisfying selected zones.
- The procedure is required to calculate a Pick value for each item for which Bulk Pick (abs_chr07) is set to yes.
- Pack Bay quantity for a particular Site/Item/Location/Zone is calculated, which helps in calculating total pick quantity.
- The procedure also shows the pick location with the location status (maintained in generalized codes) where inventory exists that is greater than or equal to the pick quantity. If no location is selected, the system displays the location with the location status (maintained in generalized codes) having the oldest inventory available.
- The procedure utilizes timeout logic like WO to delete the dcWorkFile if the user holds the record open for too long and the pick time is exceeded.

The procedure provides the back-office supervisor with visibility of open pick requirements.

Note A QAD customer created a .NET browse, xubr888.p to mimic our DC look-up. The results of the .NET browse should mirror the results of the DC look-up for items that need to be bulk picked. Please contact QAD Services for more details.

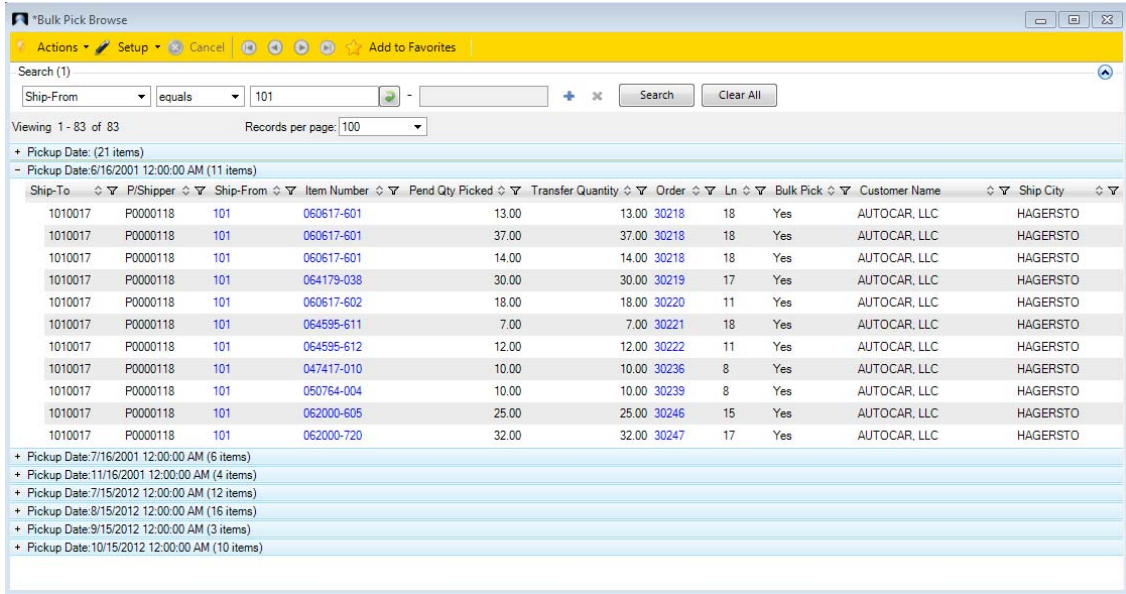



Field Information

Field Name	Comments
ttTransLotSerial - Transfer by Item	
^Pick Zone <i>(Data entry field)</i>	<p>Enter Zone(s) to pick for “R1 R2 R3”</p> <p>Validations:</p> <ul style="list-style-type: none"> Blank entry is not allowed The Zone is a valid generalized code per the loc_mstr.loc_type MFG-11384 invalid value. There is 1 record and the generalized code exists where fieldname = SO_BULKPICK_STATUS <p>Look-up Purpose: Display list of Zones available</p> <p>Look-up Name:</p> <p>Auto-display:</p> <p>Default Selected Values:</p> <p>Look-up Query Rules: Where generalized code field type = “loc_type“</p> <p>Note: The Pick Zone Lookup query rule is not clear. Do you want to see all the zones for a login domain? This setup is done in Generalized Code Maint and it is based on Domain and not the login site.</p> <p>Look-up Fields:</p> <ul style="list-style-type: none"> Zone (Sort 1 ascending): The Type field in location Maintenance Description: Description of Zone (Type) field
Pick Thru Date <i>(Data entry field)</i>	<p>Define how far into future to bulk pick. Defaults to tomorrow’s date.</p> <p>Hide field after the user enters the value.</p>
Pick Time <i>(Data entry field)</i>	<p>Optional: Define how many hours into the future to bulk pick. For example, set the pick time for someone picking the next day through 12pm.</p> <p>Default: 11:59</p> <p>Hide field after the user enters the value.</p>

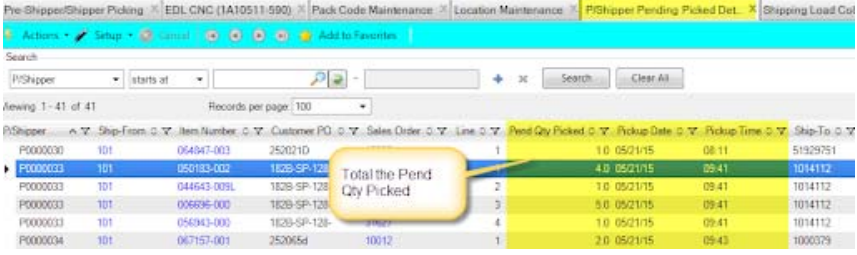
Field Name	Comments
^Item # (Data entry field)	<p>Select: item from Look-up/Input.</p> <p>DC Workfile is created to indicate the item that the user has selected to work on.</p> <p>Look-up Purpose: Display list of Zones from Location Maintenance Type field</p> <p>Look-up Name: Items to Bulk Pick</p> <p>Auto-display:</p> <p>Default Selected Values:</p> <p>Look-up Query Rules:</p> <ol style="list-style-type: none"> Find items for the selected Pick Zone(s). Where Pre-Shipper field abs__chr07" "bulk pick" field = yes <ul style="list-style-type: none"> ----a. Where Pre-Shipper Pick QTY > 0 exists ----b. Where location detail status (ld_det.ld_status) = 1 or more gen codes values (gen code field name "SO_BULKPICK_STATUS"). -----Where available inventory exists per location detail type (ld_det.ld_type) "Zone" = selected Pick Zone(s) Or, Where inventory exists in Location Type (ld_det.ld_type) = "selected Pick Zones", and Location Status = "Pbay" and there are no active pre-shippers for the item (regardless of pick date). The concept is to return products that have no demand for picking. <div style="text-align: center; margin-top: 20px;"> <p>The diagram illustrates a grid of zones. The top row (A105-A113) is labeled 'Zone = W2(Loc Type) Status = Good'. The bottom row (B105-B113) is labeled 'Zone = W1(Loc Type) Status = Good'. A callout box points to the B110 cell, stating 'If no pre-shippers for item, then negative pick requirement'. A red arrow points from the B110 cell to the B109 cell. The B111 cell contains the value '100' and is labeled 'Status = PBay'.</p> </div>

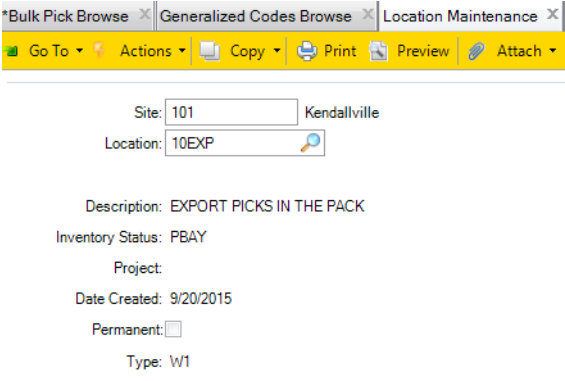
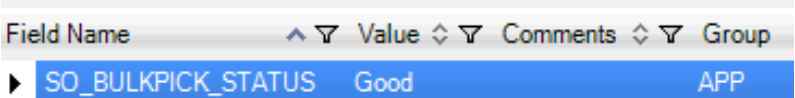
Field Name	Comments
^Item # (continued) (Data entry field)	<p>Look-up Fields:</p> <ul style="list-style-type: none"> • P: Indicates there is a user picking this material. • Picker Name: Displays the user ID of the user who has selected this item to pick. A DC workfile is created for the user ID and Item Number when the user selects the item to pick. The purpose of the field is to prevent multiple people from working on the same pick by showing other users that someone is working on this pick. Note: If both users select the item at the same time to pick, it is possible both users will work on the same pick. This should be a rare exception with no negative business impacts. Includes the scenario for SO Bulk Pick where 2 users select different zones but both users are directed to pick the same component. What if a user does not complete the transaction or aborts? How does the field get cleared? ----1. Add a time-stamp on the record (item) selected by the user. ----2. Use the DC transaction dummy field to define the picktimeout, such as 5 minutes. dPickTimeout in buffer dtTransLotSerial ----3. When the user opens the Item Look-up, remove all DC workfile records where current time compared to time-stamp is > than picktimeout Req QTY: [Pending QTY Picked - Pack Bay Qty] Pending Qty Picked: [Total all open preshippers Pend Qty Picked per item] • Pick Loc: Finds the suggested pick location per the following rules for positive picks: ----1. Where location detail type (ld_det.ld_type) = selected Pick Zone(s) ----2. Where location detail status (ld_det.ld_status) = 1 or more gen codes values (gen code field name "SO_BULK_PICK_STATUS") ----3. Where location QTY is >= Pick QTY AND oldest create date. Otherwise, oldest inventory location create date where location detail type = selected Pick Zone(s).  <p>The screenshot shows a SAP table with columns: PShipper, Ship-From, Item Number, Customer PO, Sales Order, Line, Pend Qty Picked, Pickup Date, Pickup Time, and Ship-To. A callout box highlights the 'Total the Pend Qty Picked' column.</p> <ul style="list-style-type: none"> • Pick Loc: Finds the location to return materials from when no pre-shippers are open per the rules for negative picks: ----1. Where location detail type (ld_det.ld_type) = selected Pick Zone(s) ----2. Where location detail status (ld_det.ld_status) = "Pbay" ----3. select first location per ld_det create date • PackBayQOH: Site/part/location where location type is "PBay" • Pick-Up Date/Time: Displays the oldest record date/time for the Pre-Shippers that are found with open pick requirements. • Shipper: Displays the pre-shipper/shipper that are driving the requirements. Displays the ID related to the Pick-up Date and Time displayed. • Pick QTY Example: Item 064874-003 (130 - 30 = 100) • Zone: Defined per the location type (ld_det.ld_type) • Picker Name: Used for trouble-shooting, such as when a record shows it is in pick status and no other users are logged in.
Description	Description of input/scanned item
UM	Unit of Measure of input/scanned item

Field Name	Comments
Pack Bay Qty	<p>Displays the QOH for the selected item where loc_det_status = "PBAY" for selected Pick Item + Zone. See Pack Bay QTY look-up rules for calculation.</p> 
Pick Req	Displays the required Pick QTY for the item. See Pick QTY look-up rules for calculation.
Pick Loc	Displays the recommended pick location for the record selected in the Item look-up.
Pick Avail	Displays the (Ld_QTY_OH) of Pick Loc.
<p>^Loc From (Data entry field)</p>	<p>Enter/scan location to transfer material from. Do not default value selected from the look-up.</p> <p>Validate: Location is valid Look-up Name: Item Locations Auto-Display: No Default Selected Values: Look-up Query Rules:</p> <ol style="list-style-type: none"> Where Non-Zero balance inventory locations for the selected item number. Displays the location one time even though multiple ld_dets may exist. Where location (ld_det.ld_status): <ul style="list-style-type: none"> ----a. Status = gencodes. See example below.  <ul style="list-style-type: none"> ----b. AND qty = loose inventory only ----c. AND qty = non-detail allocated > 0 <p>Look-up Fields:</p> <ul style="list-style-type: none"> • QOH: QOH = loose + non-detail allocated inventory only. Note: Because loose inventory consists of Allocated and non-Allocated inventory, the QOH will not be correct if it equals loose + non-detail Allocated. Although we should display QOH as non-detail allocated (loose inventory). An approach could be QOH = Loose Qty - Allocated Qty inventory. But, in allocated inventory we do not have separation for serialization and loose quantity. • Location: • Created: • Zone: • Loc Status:

Field Name	Comments
Qty to Pick <i>(Data entry field)</i>	<p>Input quantity to transfer.</p> <p>Validate:</p> <ul style="list-style-type: none"> Quantity greater than zero. User cannot transfer more than available to transfer. <div style="text-align: center;">  <p>ERROR: Quantity available in site location for lot/serial 40. Please re-enter.</p> <hr style="width: 50%; margin: 10px auto;"/> </div> <p>Default: Qty for the entered From Location (total qty in the location). Note: user will not select location from look-up.</p>
Lot/Serial From	Only applicable if inventory in the From Location has lots. Otherwise, user is not prompted.
Reference	Only applicable if inventory in the From Location has lots. Otherwise, user is not prompted. Field not mandatory if no Reference is tied to the Lot/Serial.
^Loc To <i>(Data entry field)</i>	<p>Enter/scan location to transfer.</p> <p>Rule: The ld_det status needs to be set to the location STATUS of the TO LOCATION.</p> <p>Look-up Name: Item Locations (Putaway Locations)</p> <ul style="list-style-type: none"> If the user is picking for a positive requirement, the look-up is disabled. If the user is returning for a negative requirement and the Zone is defined for the item per pti_det.pti_site_loc, THEN auto-display Putaway look-up. Do not default value from the selected value look-up. <p>Auto-Display: No</p> <p>Default Selected Values:</p> <p>Look-up Query Rules:</p> <ul style="list-style-type: none"> Do not display locations of selected Location From. Do not display location more than once. Consolidate the inventory quantities if multiple lot records exist. If Zone Storage Location (pti_det.pti_site_loc) = "non-blank" per item: <ul style="list-style-type: none"> a. Find/display Non-Zero balance inventory locations per selected item number where Location Type (loc_mstr.loc_type) = Zone Storage Location (pti_det.pti_site_loc) b. Find/display inventory locations with Location Type (loc_mstr.loc_type) = to Zone Storage Location (pti_det.pti_site_loc) per item site master where Zero balance, including locations where an ld_det record does not exist. Location Status only = "GOOD" <p>Validate: Valid location. Location is not the same as the source location.</p>
Review Before Commit <i>(Data entry field)</i>	Any input entered will complete the transaction. If data is incorrect, the user should press F4 to go back and correct it.

Troubleshooting

Issue/Error	Root/Solution
 <p>The screenshot shows a terminal window titled 'Inventory Transfer V.0002 Primary Input Fields'. A 'Messages' box is open, displaying the text: '>MFG-6864 ERROR: User is restricted for this record. Please re-enter.' Below the message is an '< OK >' button.</p>	<p>Per Inv Transfer Restriction Maintenance, user ROLE does not have permission to transfer inventory.</p> <ul style="list-style-type: none"> • See Inv Restriction Maintenance for settings. • See Role Permissions to see associated roles of users.
<p>Item is not displayed in the DC browse, but it does display in the .NET browse (55.7.9.20, xxbr056.p).</p>	<p>Item Master 1.4.17 field pti__qadc01 is not populated with a zone.</p>

SO Pre-Shipper Create

Use this transaction to create a Sales Order Pre-Shipper on demand by scanning the LP. It also allows users to create a Pre-Shipper ID on the fly by scanning the LP to find the customer ship-to information they will need to create pre-shipper for.

Transaction Technical

DC Menu	DC Menu Name	DC Transaction Technical Name	Production Order .NET Menu Action
7.1.2	Outbound Shipment	SO Pre-Shipper Create	Trans: Pre-Shipper-Shipper Picking - Create Shipper App: Pre-Shipper/Shipper Picking (7.8.1, pasopi.p)

Limitations / Exceptions

- Key Assumption: 1 Pre-shipper per Master Pack
- The LP that is scanned must have a linked sales order number because the transaction is not configured to build a pack and it does not prompt the user for Item, SO#, and Line.

Minimum System Setup

N/A

Minimum Data Required

N/A

Transaction Flow Chart

Fig. 4.2
SO Pre-Shipper Create

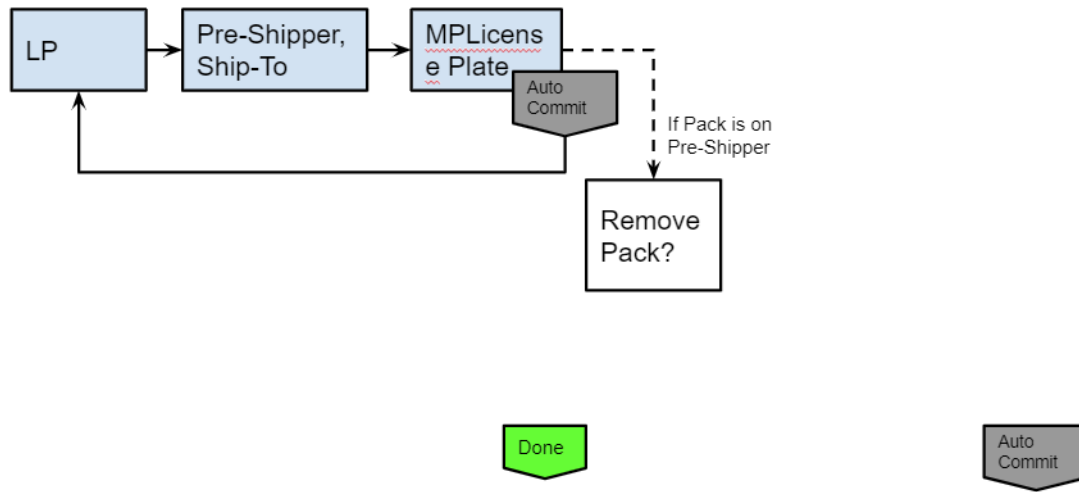

Field Information

- **Purpose:** Select/Find the Pre-Shipper to pick for.
- **Assumption:** The transaction starts when the user scans the LP to find the Shipper they need to pick against.
- This transaction supports all inventory types

Field Name	Comments
tt...	
License Plate <i>(Data entry field)</i>	Scan the Master Pack LP to find open pre-shippers for the LP. If no SO# is found on the LP or user leaves field blank, then prompt for Pre-Shipper Nbr. Validate: LP is Active Status <div style="border: 1px solid #ccc; padding: 5px; width: fit-content; margin: 10px auto;"> <p>Ship-From ID: <input type="text"/></p> <p>Pre-Shipper/Shipper: <input type="text" value="Pre-Shipper"/></p> <p>Number: <input type="text"/></p> <p>Ship-To/Dock: <input type="text"/></p> </div>
Ship-From ID (hidden)	Defaults according to the Site of the Destination LP
Pre-Shipper/Shipper (hidden)	Defaults Pre-Shipper = yes
^Pre-Shipper Number	Defaults if Pre-Shipper is found when LP is scanned. Otherwise, leave field blank for system assignment. Note: The number will not display if left Blank until commit.
Ship-To/Dock	Default value per the Pre-Shipper Number or, Default value per the SO# per scanned LP Otherwise, prompt user for Ship-To.

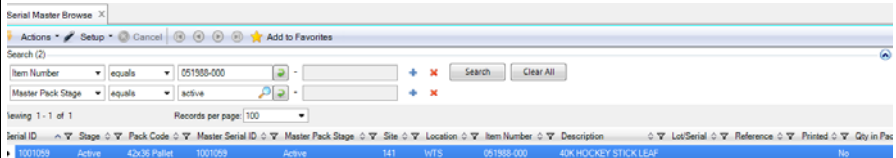
Field Name	Comments
tt... - LP/Item Picking	
Pre-Shipper Nbr	Redisplay
Customer	Display Ship-To Customer Name
Order	Conditional: Default SO# per selected LP + linked SO # If SO# number is not found, prompt for SO#.
Line	Defaults to the first open SO Line Number for selected item number within the LP. Assume a single item in LP.
Req Pick	Display per Sales Order/Line
From Location	<p>Displays Location of License Plate</p> <p>Look-up Name:</p> <p>Auto-display:</p> <p>Look-up Query Rules: Find/display all License Plated (serial master records) inventory records where serial master status = "active" and location status = "available" for the selected item per prior field.</p> <p>Look-up Fields:</p> <ul style="list-style-type: none"> • Location (Sort 2 ascending) • Serial ID • QTY in Pack: If the user selects a master pack, there could be multi-levels in the pack structure where the same item exists. Display the total QTY of the item within the pack structure. • Multi-item Pack (Yes/No): Indicates if the user selects a master pack that contains multiple items. For example, the master pack may contain 5 boxes of item A (each box qty of 10) and 5 boxes of item B(each box qty of 5). • Please reference the Serial Master Browse example below to identify where the data is pulled for a serial ID of a pack (license plate). • Created (Sort 1 ascending) • Pack Status (ld_det) • Loc Status (oc_mstr.loc_status) • Loc Type 

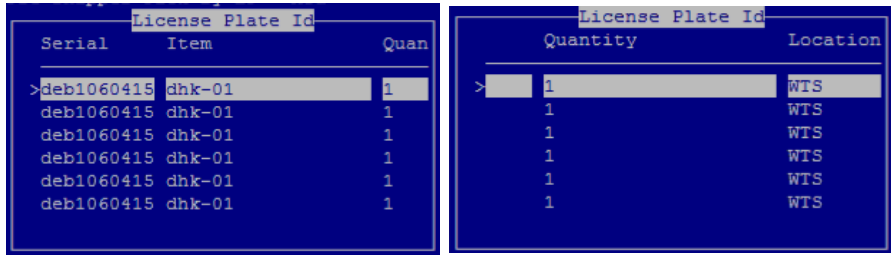
Field Name	Comments
^MP License Plate	<p>Defaults to the LP ID from the prior frame if scanned.</p> <p>Input/scan/look up Pack Serial ID.</p> <p>Validations:</p> <ul style="list-style-type: none"> • If the user enters a Serial ID that is already picked for the Pre-Shipper, the user is prompted with the following question: “Remove pack/item from Pre-Shipper/Shipper?” If Yes, serial ID is unpicked and user is returned to Serial ID field. If No, user is returned to Serial ID field. • System shall validate the LP belongs to the sales order on the pre-shipper <p>Look-up Name:</p> <p>Auto-display:</p> <p>Look-up Query Rules:</p> <p>Look-up Fields:</p> <p>Display the LPs that are already assigned to pre-shipper and the LPs that match the same SO# per the ser_mstr user field 1.</p>  <p>Add a new column on the very left called “PICKED”:</p> <ul style="list-style-type: none"> • If Serial ID is picked, then value = “YES”. • If Serial ID is not picked, then value = “NO”.
Remove pack/item from pre-shipper/shipper (Conditional) (Data entry field)	<p>Enter Yes to remove Serial ID from Pre-Shipper/Shipper. Enter No to return to Serial ID prompt.</p> <p>Conditional: Field only displays if user scans an LP that already exists on the Pre-Shipper.</p>
Pack Qty	Defaults from Serial ID
To Loc (Data entry field)	<p>Input/scan/look up Location to transfer Pre-Shipper/Shipper to.</p> <p>Look-up Name:</p> <p>Auto-display:</p> <p>Look-up Query Rules: Display location where item exists except for From Location.</p> <p>Look-up Fields:</p> <ul style="list-style-type: none"> • Location (Sort 2 ascending) • Serial ID • QTY in Pack • Created (Sort 1 ascending) • Pack Status (ld_det) • Loc Status (oc_mstr.loc_status) • Loc Type
Confirm (Data entry field)	Enter Yes to Confirm transaction or enter No to leave.

Pre-Shipper Pick

This transaction allows users to pick inventory for a pre-shipper when that inventory is License Plated. It also supports Pre-Shipper picking when inventory is License Plated and it is picked for pre-shipper requirements.

Transaction Technical

DC Menu	DC Menu Name	DC Transaction Technical Name	Production Order .NET Menu Action
7.1.3	Outbound Shipment	Pre-Shipper Pick	Trans: Pre-Shipper-Shipper Picking-by LP PARENT App: Calls linked transactions
7.1.3-1	Outbound Shipment	Linked	Trans: Pre-Shipper-Shipper Picking - Pick by LP App: Pre-Shipper/Shipper Picking (7.8.1, pasopi.p)
7.1.3-2	Outbound Shipment	Linked	Trans: Pre-Shipper-Shipper Picking - by DO App: Pre-Shipper/Shipper Picking (12.9.1, padopi.p)

Limitations / Exceptions

Does not support configured products.

Minimum System Setup

N/A

Minimum Data Required

- Pre-Shipper
- Serialized (Packaged Item) inventory

Transaction Flow Chart

Fig. 4.3
SO Pre-Shipper Pick

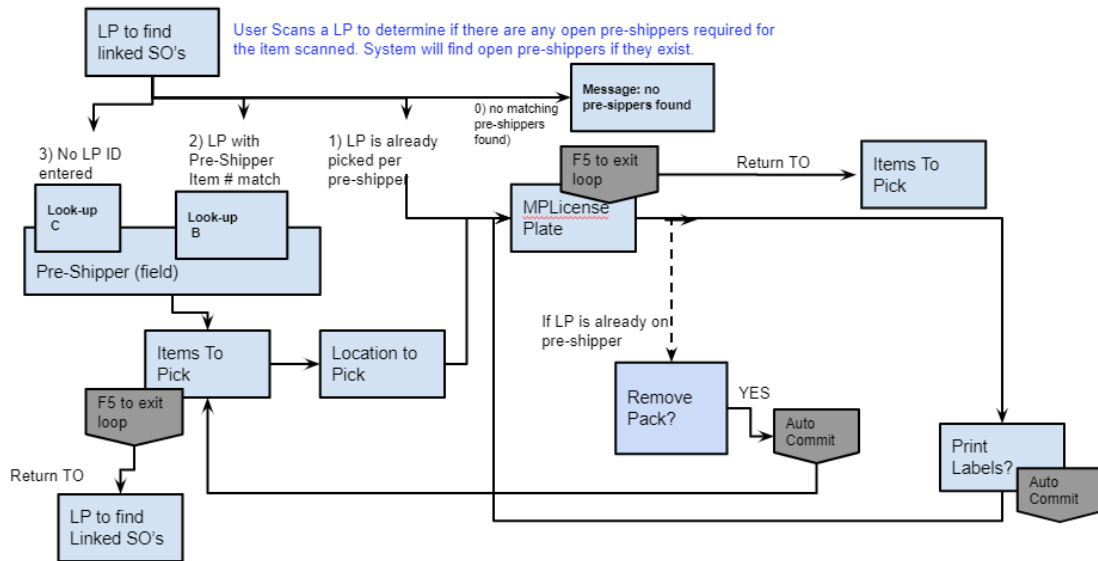

Field Information

Field Name	Comments
ttShipper - Shipper	
^Shipper Number (Data entry field)	Input/scan/look up Shipper Number. Validate: <ul style="list-style-type: none"> Valid sub-contract shipper Shipper must be unconfirmed Blank entry is allowed Look-up Purpose: Select the shipper number for the sub-contract PO or create a shipper number. Look-up Name: Auto-display: Default Selected Values: Location Query Rules: <ul style="list-style-type: none"> Domain = login domain Site = login site Shipper number is not confirmed Look-up Fields: <ul style="list-style-type: none"> ID (Sort 1 ascending): Shipper ID Sup: Supplier number
ttSerial - Serial	

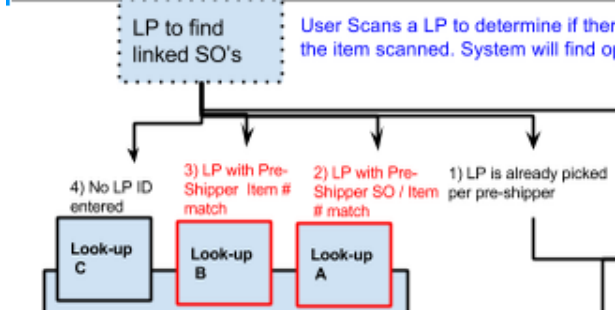
Field Name	Comments
LP (Serial ID) <i>(Data entry field)</i>	<p>Scan the Master Pack LP to find open pre-shippers for the LP/Item.</p> <p>Note: SO# must be associated to the LP for the system to find open pre-shippers for the LP. Use the Pack Create by WO DC transaction to write the SO# to the serial_user1 field.</p> <p>Validate: LP is Active Status and not picked. If Picked, display an error that states LP is already picked per Pre-Shipper “XYSYD”.</p> <p>Post Process: As a post process, apply the following rules to the Pre-Shipper Field:</p> <p>Note: The advanced logic defined below may not be required by Truck but it will be required by Bumper/Trim when scanning a box LP to find the pre-shippers they need to pick for.</p> <ol style="list-style-type: none"> 1. If LP is picked, default Pre-Shipper ID of LP. 2. If LP, auto display Pre-Shipper Look-up A (list of pre-shippers matching) where LP Item & SO# (ser_mstr user_1) = 1 or more Pre-Shipper Item & SO# record, 3. If LP, auto display Pre-Shipper Look-up B where LP Item = pre-shipper Item. 4. If no open pre-shippers exist, display error, “No Open Pre-shippers found per LP/Item/SO”. 5. If the user does not enter an LP ID, then auto-display Pre-Shipper Look-up C. <p>Details of Post Process Rule 1 and 2a. If a single pre-shipper is found for the scanned LP, the user should automatically be advanced to this point in the transaction:</p>  <p>Look-up C: Same look-up as Pre-Shipper LP by Item (pre-Shipper look-up) If no LP is scanned, then display “See Pre-Shipper LP by Item for details on look-up logic.”</p>
Ship-From ID (hidden)	Defaults according to the Site of the Destination LP
^Pre-Shipper/Shipper (hidden)	Defaults Pre-Shipper = yes
^Pre-Shipper Nbr	Defaults if Pre-Shipper is found when LP was scanned. Input/scan/look up Pre-Shipper/Shipper Number. Validation: If the pre-shipper record is accessed from 7.9.2 and the user enters the same pre-shipper number in the DC transaction, a record lock error will be displayed to the user.
Ship-To/Dock (Hidden)	Defaults per Pre-Shipper selected
Pre-Shipper Nbr	Redisplay
Customer	Display Ship-To Customer Name
^Item Number	User selects the item to pick and the order, line, Req Pick information is defaulted in the next fields. OR Item number defaults from the LP that was scanned in Frame 1.
Order	Defaults the SO# for the selected item number.

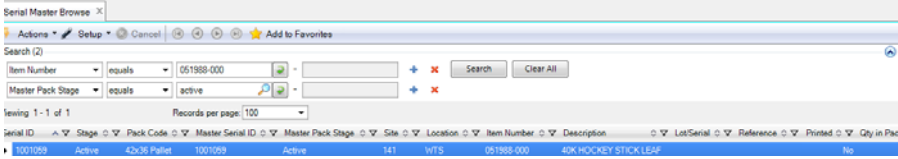
Field Name	Comments
Line	Defaults the Line Number for the selected item number.
Req Pick	Defaults from Sales Order for the selected item number.
From Location	<p>Auto-display list of locations Serialized items can be found in.</p> <p>OR</p> <p>Defaults according to the Location of scanned LP.</p> <p>Look-up Name:</p> <p>Auto-display:</p> <p>Look-up Query Rules: Find/display all License Plated (serial master records) inventory records where serial master status = “active” and location status = “available” for the selected item per prior field.</p> <p>Look-up Fields:</p> <ul style="list-style-type: none"> • Location (Sort 2 Ascending) • Serial ID • QTY in Pack: If the user selects a master pack, there could be multi-levels in the pack structure where the same item exists. Display the total QTY of the item within the pack structure. • Multi-item Pack (Yes/No): Indicates if the user selects a master pack that contains multiple items. For example, the master pack may contain 5 boxes of item A (each box qty of 10) and 5 boxes of item B(each box qty of 5). Please reference the Serial Master Browse example below to identify where the data is pulled for a serial ID of a pack (license plate). • Created (Sort 1 ascending) • Pack Status (ld_det) • Loc Status (oc_mstr.loc_status) • Loc Type • LP Date 

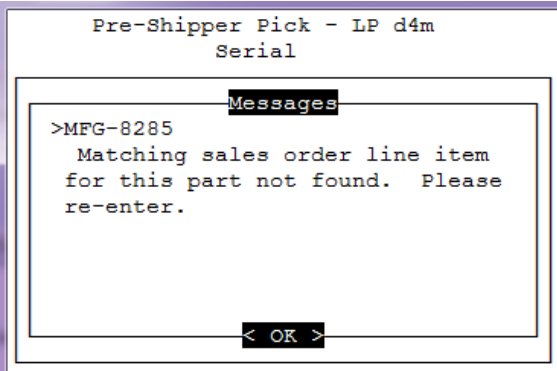
Field Name	Comments
Serial ID ^MP License Plate (Data entry field)	<p>Input/scan/look up Pack Serial ID.</p> <p>Validation: If the LP has items on it that are not on the pre-shipper, display the following error: “Items in LP not required by shipper”.</p>  <p>Note: If the user enters a Serial ID that is already picked for the Pre-Shipper, the user is prompted with the following question: “Remove pack/item from Pre-Shipper/Shipper?” If Yes, serial ID is unpicked and user is returned to Serial ID field. If No, user is returned to MP LP ID field.</p> <p>Look-up: Display the LPs that are already assigned to the pre-shipper.</p>
Remove pack/item from pre-shipper/shipper (Conditional) (Data entry field)	<p>Conditional: Enter Yes to remove the Serial ID from Pre-Shipper/Shipper. Enter No to return to the Serial ID prompt.</p>
Print Labels (Data entry field)	<p>Default = Yes</p> <p>Creates request to License Plate Label Print</p>
<p>Linked Transaction: LPS EVENT CALL (License Plate Label)</p> <p>Purpose: Print customer labels for an LP that is being added to a pre-shipper.</p> <p>Key Assumption: The LP must be associated to the pre-shipper to print the customer-specific labels.</p> <p>Note: We do not call this as a linked transaction. We create an LPS event passing the values below.</p>	
<p>tt... - License Plate Label Transaction</p>	
Pass in the following variables:	<p>Pass the following field values from EDL Receipts to:</p> <ul style="list-style-type: none"> • LP ID = ID per the WO Receipt By Pack Transaction • Lbl Type = MPUpdate • PrintLabel = Yes
Display the following transaction fields	<p>All fields should be hidden</p>
Technical Implementation	

Pre-Shipper Pack

This transaction allows you to do the following:

- Create a new License Plate on a Pre-Shipper or Shipper.
- Modify an existing License Plate on a Pre-Shipper.

- Create a new License plate, searching for Pre-Shippers by Item Number.
- Perform Pre-Shipper picking for a SO and DO where inventory is loose and you pick and package it according to the pre-shipper requirements.

Transaction Technical

DC Menu	DC Menu Name	DC Transaction Technical Name	Production Order .NET Menu Action
7.1.4	Outbound Shipment	Pre-Shipper Pack	Trans: Pre-Shipper-Shipper Pack Build-PARENT App: Calls linked transactions
7.1.4-1	Outbound Shipment	Linked	Trans: Pre-Shipper-Shipper Pack Build - DO App: Pre-Shipper/Shipper Pack Build (12.9.2 padopa.p) Linked Trans: Pack Transfer linked with prompt Linked Trans: LP Weight Modify linked with prompt Linked Trans: Transfer With Lot-Serial Change - Item Version
7.1.4-2	Outbound Shipment	Linked	Trans: Pre-Shipper-Shipper Pack Build - Item - SO App: Pre-Shipper/Shipper Pack Build (7.8.2, pasopa.p) Linked Trans: Pack Transfer linked with prompt Linked Trans: LP Weight Modify linked with prompt Linked Trans: Transfer With Lot-Serial Change - Item Version

Limitations / Exceptions

- This transaction does not allow users to remove an LP. See LP Remove transaction.
- This transaction is intentionally designed not to allow users to modify Shippers because it can cause synchronizing issues with TMS. This prevents TMS from getting out of sync with QAD.

Minimum System Setup

N/A

Minimum Data Required

N/A

Field Information

Field Name	Comments
<p>Pre-Shipper/Shipper Pack Build (Parent) Transaction: Pre-Shipper/Shipper Pack Build Purpose: Select/find the pre-shippers to pick for. tt...- Pre-Shipper LP by Item (Shipper)</p>	
^Pre-Shipper No <i>(Data entry field)</i>	Input/scan Pre-Shipper or Shipper number. Alternative: User can enter a Blank and search for pre-shippers by item. Validate: <ul style="list-style-type: none"> • Validate ID is Pre-Shipper only • Validate Shipper has not been rated in TMS • Validate Shipper is not confirmed Look-up Purpose: Display list of customers who have open pre-shipper IDs/numbers Look-up Name: Pre Shipper No Query Rules: <ul style="list-style-type: none"> • Pre-shippers where ship-from = user log-in site • Pre-Shippers only with or without open pick requirements Look-up Fields: <ul style="list-style-type: none"> • Pick: If Yes, there are open pick requirements (pending picks). • Customer Name • Pickup Date: “custom field l_pick_date” per 7.9.2” • Pickup Time: “custom field l_pick_time” per 7.9.2” • Ship To • Ship Date • ID
Item Number (Conditional) <i>(Data entry field)</i>	Conditional: User is prompted only if Blank Pre-Shipper No is entered. Input/scan Item Number to find Pre-Shippers to pick and ship against.
<p>Transaction Detail - Pre-Shipper LP by Item (Parent Serial) Transaction: Pre-Shipper/Shipper Pack Build Purpose: Select create/modify license plate. tt...</p>	
Pre-Shipper No	Redisplay pre-shipper no.
LP Gross	Displays gross weight of last LP modified.
Sh Gross	Displays the Gross weight of all LPs per ser_mstr.

Field Name	Comments
MP License Plate ID (Data entry field)	<p>Input/scan the existing LP or leave Blank to create a new LP.</p> <p>Validation: For the Pre-Shipper LP Modify version, validate the LP already exists on Pre-Shipper.</p> <p>Look-up Purpose: Display the list of LP numbers associated with this pre-shipper.</p> <p>Look-up Name: MP License Plate ID</p> <p>Auto-Display:</p> <p>Query Rules: Display the list of LP numbers (stage = picked) associated with this pre-shipper.</p> <p>Look-up Fields:</p> <ul style="list-style-type: none"> • Serial [format x(12)] • Item • QTY • Loc
Remove Item From Pre-shipper (Conditional) (Data entry field)	<p>Conditional:</p> <ul style="list-style-type: none"> • If user enters existing LP ID, prompt user. Default = “NO” • If user enters “YES”, see remove item from pre-shipper flow.
Pack Code (Conditional) (Data entry field)	<p>Conditional: Designate the pack code for the License Plate. Only applies to new LPs.</p> <p>Look-up Purpose: Display the list of Pack Codes.</p> <p>Look-up Name: Pack Codes</p> <p>Auto Display:</p> <p>Query Rules: Displays all Pack Codes</p> <p>Look-up Fields:</p> <ul style="list-style-type: none"> • Pack Code • Description
Transaction Detail - Pre-Shipper LP by Item (Child Serial)	
Transaction: Pre-Shipper/Shipper Pack Build	
Purpose: Select items to pick per pre-shipper pending pick requirements tt...	
Pre-Shipper No	Redisplay pre-shipper no.
MP LP	Redisplay LP, if entered in prior frame 1 MP LP field.

Field Name	Comments
^Item Number <i>(Data entry field)</i>	Input/scan Item Number. Look-up Purpose: Display a list of open items (pending pick) associated with this pre-shipper. Look-up Name: Pending Pick Required Auto-Display: No Query Rules: Look-up Fields: <ul style="list-style-type: none"> • Item • Pick_Req • SO number • Line Num • Cust PO • Loc: The FIFO location of the item per inventory control file settings. <p>- Picking Logic _____</p> <p>1) Location</p> <p>2) Lot/Serial</p> <p>3) Date</p> <p>4) Expire Date</p> <p style="text-align: center;">Picking Order: <input type="text" value="3"/></p> <p style="text-align: center;">Ascending or Descending: <input type="text" value="Ascending"/></p> <ul style="list-style-type: none"> • Alloc: Does the item have detailed allocations? If yes, then there are detailed allocations.
Order	Defaults from Pre-Shipper and Item Number.
Line	Defaults from Pre-Shipper and Item Number.
Req Pick	Defaults from Pre-Shipper and Item Number.
^Location From <i>(Data entry field)</i>	Enter the location the inventory is to be pulled from. If existing LP is selected, the default Location is the LP location. This facilitates negative picks. If doing a removal, the Location is set to the LP location and the field is read-only. Look-up Purpose: Display a list of locations with the item to be shipped. Look-up Name: Item Locations Auto-Display: Query Rules: <ul style="list-style-type: none"> • Display locations per user log-in site • Locations with QOH > 0 • If no detail allocations, locations where unallocated > 0 Look-up Fields: <ul style="list-style-type: none"> • Loc • QTY OH: The amount of inventory available at that location. • Lot • Ref
ReScn Item <i>(Data entry field)</i>	Input/scan Item Number for verification.

Field Name	Comments
Quantity to Pick <i>(Data entry field)</i>	Enter the quantity to pick for the License Plate. If removing items from the LP, see Alternate Flow. If a user enters a negative value, validate that the Location = LP Location. Validate: Allow Positive values only.
Picked	Displays the quantity the user has picked (format “->,>>>,>9.9”)
Packed	Displays the total quantity of items the user has picked on the License Plate
Confirm <i>(Data entry field)</i>	Enter to confirm the creation or modification of the License Plate.
Linked Transaction Detail - Pack Transfer	
Transaction: Pack Transfer	
Purpose: Transfer the new license plate, including items in license plate, to WTS.	
Key Assumption: Only occurs when LP is not in WTS. User does not see any prompts. tt...	
	Fields to pass into Transaction: <ul style="list-style-type: none"> • LP ID: Created/entered in prior transaction step. • To Location: WTS
Linked Transaction Detail - Weight Modify	
Purpose: Modify the Gross weight of an LP tt...	
Serial ID	Defaults from a previous process
Item	Defaults from a previous process
Pack Qty	Defaults from a previous process
Net Wt	Defaults from a previous process
Tare Wt	Initially defaults from a previous process. This can be recalculated based on the Gross Weight input by the user.
Gross Weight <i>(Data entry field)</i>	Input the Gross Weight if it is different than the calculated amount.
Linked Transaction Detail - Print Label	
Transaction: Label Print	
Purpose: Provide ability to print /reprint LP shipper labels tt...	
Serial ID created <i>(Data entry field)</i>	User accesses this prompt after pressing F5-Done on MP License Plate ID screen, which ends the process. Enter Y to print label and enter N to skip label print.

Remove Item from Pre-shipper

Field Name	Comments
Transaction Detail - Pre-Shipper LP by Item (Parent Serial)	
Transaction: Pre-Shipper/Shipper Pack Build	
Purpose: Select an existing LP to modify and then remove the item quantities from the LP.	
Key Assumption: User responds “Yes” to question below tt...	
Pre-Shipp No	Redisplay per prior frame
MP LicP	Redisplay per prior frame

Field Name	Comments
Remove item from pre-shipper? <i>(Data entry field)</i>	For the Pre-Shipper Pick by Item version, Hide field and default value = "NO" For the Pre-Shipper LP Modify, Hide field and default value = "YES"
Transaction Detail - Pre-Shipper LP by Item (Child Serial)	
Transaction: Pre-Shipper/Shipper Pack Build	
Purpose: Select and existing LP to modify and then remove the item quantities from the LP.	
Key Assumption: User enters quantity of items to remove in the next screen/fields. tt...	
Pre-Shipper No	Redisplay pre-shipper no.
MP LP	Redisplay LP, if entered in prior frame 1 MP LP field.
Item (Conditional)	Conditional: Prompt if multiple items are found for the LP. Otherwise default/display only.
Order (Conditional)	Conditional: Prompt if multiple SO are found for the LP. Otherwise default/display only.
Line (Conditional)	Conditional: Prompt if multiple SO are found for the LP. Otherwise default/display only.
Req Pick	Defaults from the Pre-Shipper and Item Number.
Location	Location = to LP location
ReScan Item <i>(Data entry field)</i>	Enter/Scan item displays above.
Quantity to Remove <i>(Data entry field)</i>	Enter the quantity to remove. Validate: QTY =< QTY in LP
Picked	ReDisplay the QTY to Remove
Packed	ReDisplay the QTY in LP - QTY to Remove
Confirm <i>(Data entry field)</i>	Enter to confirm the modification of the License Plate.
Linked Transaction Detail - Weight Modify	
Purpose: Modify the Gross weight of an LP tt...	
Serial ID	Defaults from a previous process.
Item	Defaults from a previous process.
Pack Qty	Defaults from a previous process.
Net Wt	Defaults from a previous process.
Tare Wt	Initially defaults from a previous process. This can be recalculated based on the Gross Weight input by the user.
Gross Weight <i>(Data entry field)</i>	Input the Gross Weight if it is different than the calculated amount.
Linked Transaction Detail - Inventory Transfer	
Transaction: Inventory Transfer	
Purpose: When removing QTY of item from LP, the Qty is transferred to a stock location.	
Item	Defaults from MP License Plate ID
Desc	Defaults from item
UM	Defaults from item
Loc From	Defaults from MP License Plate ID
Qty	Quantity to be removed that was previously entered.

Field Name	Comments
Location To <i>(Data entry field)</i>	Input location to move. Input/scan Item Number. Look-up Purpose: For the item to be removed, display a list of locations where the item has previously been located or currently has inventory. Look-up Name: Item Locations Auto-Display: No Query Rules: <ul style="list-style-type: none"> • Displays locations per user log-in site • Locations with QOH > 0 Look-up Fields: <ul style="list-style-type: none"> • Loc • QOH • Created: Inventory in new Location for 1st time • Loc St (Location Status): Status of Inventory in that location
Inventory Status	Default "Accept To Status"
Review Before Commit <i>(Data entry field)</i>	User prompted to look over information

Sub Contract Container

Use this transaction to create containers that will be included within shippers for shipments to outside subcontract processors. Users can create a single container with component items, maintain containers/items, and create containers (License Plates) for shipment.

Transaction Technical

DC Menu	DC Menu Name	DC Transaction Technical Name	Production Order .NET Menu Action
In package - not on menu	Outbound Shipment	Sub Contract Container	Trans: Sub Container Maintenance App: Sub Container Maintenance (18.22.5.4, rectmt.p)

Limitations / Exceptions

N/A

Minimum System Setup

N/A

Minimum Data Required

QMI Data to use:

- Site: 10-200
- Routing Code: 02001 used for all connector items 02001-5

- Operation: 20 Subcontract Plating
 - Supplier: 10SUBCT
- 1 **Cumulative WO.** When using QMI data, use the Cumulative Order Browse to check for a cumulative order for item 02001 and not the open cumulative order for item 02001.
 - 2 **Sub Contract PO with the Cumulative WO specified.** Search Supplier Schedule Maintenance or Purchase Order Maintenance for a supplier schedule or purchase order for supplier 10PLATSP and item 02001. Ensure that the type for line item is set to S, the Work Order ID is equal to the Cumulative Order ID found in the Cumulative Order Browse, and the Subcontract Operation for this item is 20. Verify that the operation is also populated with the correct data.
 - 3 **Verify Inventory.** View the Work Order Location by using the Work Order Bill Browse and specifying the Work Order ID from Cumulative Order Maintenance. Verify that inventory for the component item is available in this location.
 - 4 **BOM and routing setup for the parent item and location setup:**
 - Using QMI Data, verify that Routing 02001 is set up with Operation 20 selected as the subcontract operation.
 - Using QMI Data, verify that a Bill of Material is set up for item 02001. Verify that component 62050 is being added at Operation 20, the subcontract operation.
 - Verify that Locations Pack and WTS are set up.
 - 5 **Pack Code Setup.** Verify that a Pack Code and Item are set up in Pack Code Maintenance. The Pack Code and Item need to be set up identically or you need to specify the item number in Pack Code Maintenance.

Transaction Flow Chart

Fig. 4.5
Sub Contract Container

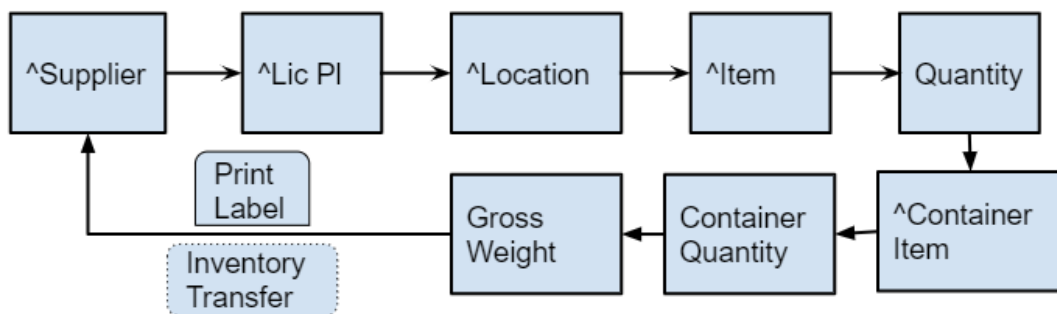

Field Information

Field Name	Comments
tt...- SubShipContainerDet	
^Supplier <i>(Data entry field)</i>	Input/scan/look up supplier. Validate: <ul style="list-style-type: none"> • Supplier number exists • Supplier is in a valid domain Look-up Purpose: Select the supplier for the sub-contract PO. Look-up Name: Supplier Auto-Display: Query Rules: Domain = login domain and there is an active scheduled PO against the supplier. Look-up Fields: <ul style="list-style-type: none"> • Sup: Supplier Number (Sort 1st ascending) • Sort Name: Supplier name (Sort 2nd ascending) • PO Number • Line
tt...- SubShipContainer	
^Lic Pl (Container) <i>(Data entry field)</i>	Input/scan/look up License Plate. Look-up Purpose: Select an existing container or create a container for the sub-contract PO. Look-up Name: Container ID Auto-Display: Query Rules: <ul style="list-style-type: none"> • Domain = login domain • Site = login site Validations: Blank entry, new entry, or existing ID Look-up Fields: <ul style="list-style-type: none"> • Cont_ID: Container ID (Sort 1st ascending) • Cont_Item: Container item (Sort 2nd ascending) • Quantity
^Location <i>(Data entry field)</i>	Input/scan/look up location. Look-up Purpose: Select the location from where you are picking/returning the items. Look-up Name: Location Auto-Display: Query Rules: <ul style="list-style-type: none"> • Domain = login domain • Site = login site Look-up Fields: <ul style="list-style-type: none"> • Loc: Location (Sort 1st ascending) • Description: Details about the location • Qty

Field Name	Comments
^Item Number <i>(Data entry field)</i>	<p>Input/scan/look up item number.</p> <p>Look-up Purpose: Select the item that you are adding or removing from the container.</p> <p>Look-up Name: Component Item</p> <p>Auto-Display:</p> <p>Query Rules:</p> <ul style="list-style-type: none"> • Domain = login domain • Site = login site • Work order status = "R" <p>Look-up Fields:</p> <ul style="list-style-type: none"> • Item • QOH • Par_Item • WO ID <p>Note: Sort by PO due date first. Sort by item number second.</p>
Quantity <i>(Data entry field)</i>	<p>Input/scan quantity for the item.</p> <p>Validate:</p> <ul style="list-style-type: none"> • If creating a new container, the quantity has to be greater than zero. • If modifying the existing container, the quantity can be zero. • If adding more items to containers, the quantity has to be less than or equal to the on hand balance for the specified location.
Container Item <i>(Data entry field)</i>	<p>Input/scan/look up container item.</p> <p>The container item relieved from the location pack</p> <p>Look-up Purpose: Select the packaging for the items being placed in the container.</p> <p>Look-up Name: Container Item</p> <p>Auto-Display:</p> <p>Query Rules: pckc_mstr.pckc_inv_part = yes by pckc_mstr.pckc_part</p> <p>Look-up Fields:</p> <ul style="list-style-type: none"> • Item Number: (Sort 1st ascending) • Pack: Pack code (Sort 2nd ascending)
Container Quantity <i>(Data entry field)</i>	<p>Input/scan container quantity.</p> <p>Validate: The quantity has to be greater than zero.</p>
tt...- SubShipContainerItem	
Item Wght	Defaults from a previous process.
Lic pl	Defaults from a previous process.
Cont Item	Defaults from a previous process.
Cont Loc	Defaults from a previous process.
Gross Weight <i>(Data entry field)</i>	Input/scan gross weight.

Field Name	Comments
Linked Transaction Detail - Inventory Transfer	
Transaction: Inventory Transfer	
Purpose: Transfer the new LP, including the component items in the LP, to WTS.	
	Fields to pass into Transaction: <ul style="list-style-type: none"> • Item: Created/entered in prior transaction step. • Location: To WTS • Quantity Assumption: When the quantity is reduced, the component items are moved from WTS back to the location.

Programs

Program	Procedure
adadxr.p	getName
dcengxr.p	getVariableValue, setFieldValue, setEventFlag, setBufferFlag, setPassBack, setVariable
dcintrxr.p	validateItemSiteCombination, IsItemLotControlled
dcshpxr.p	printShipperLabels, showSerialGenerated, getBasicSerialData, getTotalShipperWeightsAllLP, validateSerialId, isValidShipper
directmt.p	processSubContainer, fetchCompRecordsForPOWO
dcstdfp.p	pConcatValue, pCompareValue,
dcstdxr.p	CheckDCResourceSecurity, displayMessage, IsMasterExist, getRepValue, displayLargeMessage, UserPrompt, compareNumeric, ValueIsBlank
dcwkflxr.p	deleteWorkFileRecordByPrimaryKey, FieldValueByPrimaryKey, updateLogicalFieldByPrimaryKey
dcwoisxr.p	updateStdTable, validateItemOnWOBOM
lblstdxr.p	createLPSWorkFileRecord, deleteLPSWorkFileRecord
pasdxr.p	calculatePackWeight
pasexr.p	getSerialStage

Troubleshooting

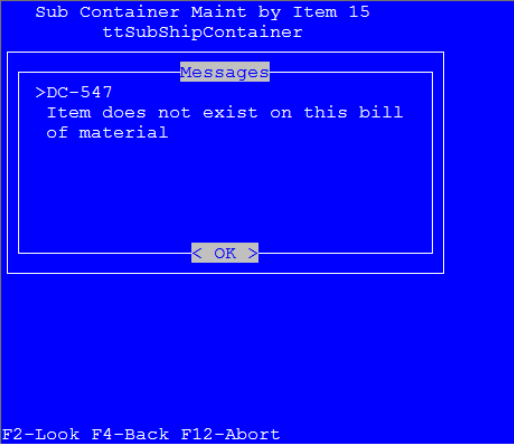
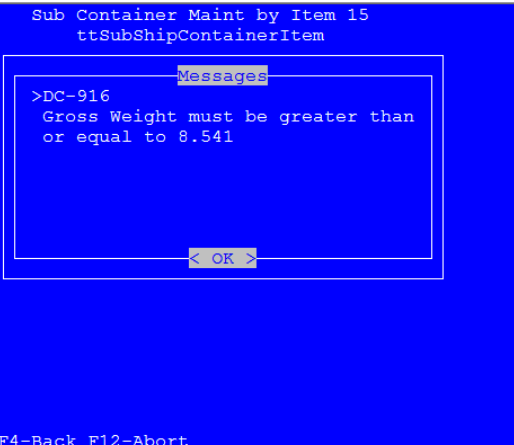
Issue/Error	Root/Solution
<p>The following error occurs when the location entered for the component item is not the same location specified on the work order bill.</p>  <p>F2-Look F4-Back F12-Abort</p>	<p>Enter the correct location on the work order bill. The work order component location can be found in the Work Order Bill Browse.</p>
<p>The following error occurs when the gross weight entered for the container is less than the standard weight for the item and container.</p>  <p>F4-Back F12-Abort</p>	<p>Enter the correct weight.</p>

Sub Contract Shipper Pick

This transaction allows users to create shippers for shipments to subcontractors and to create/modify a Sub Shipper to ship any combination of containers, items, and WIP items.

Transaction Technical

DC Menu	DC Menu Name	DC Transaction Technical Name	Production Order .NET Menu Action
In package - not on menu	Outbound Shipment	Sub Contract Shipper Pick	Trans: Sub Shipper Maintenance App: Sub Shipper Maintenance (18.22.5.5, reshmt.p)

Limitations / Exceptions

Does not support serialized inventory. Only supports loose inventory transactions.

Minimum System Setup

- 1 Create container item, parent item, and child item.
- 2 Location 'pack' should be set up for login site.
- 3 Maintain its product structure.
- 4 Set up BOM and routing for the parent item.
- 5 In Pack Code Maintenance, ensure packaging structure code is the same as the container item and that inventory item = yes.
- 6 Maintain the production line in 18.22.1.1 for the parent item.
- 7 Create a Cumulative WO for parent item from 18.22.6.1.
- 8 Create a Sub Contract PO with the Cumulative WO specified for 5.5.1.13.
- 9 Run Subcontract Order MRP % Maint (5.5.1.21) to set up the site and item and to assign the PO.
- 10 Use Schedule Maintenance (18.22.2.1) to set up schedule for the parent item.
- 11 Create container for the supplier.
- 12 Use this setup for sub shipper maintenance.

Minimum Data Required

N/A

Transaction Flow Chart

Fig. 4.6
Sub Contract Shipper Pick

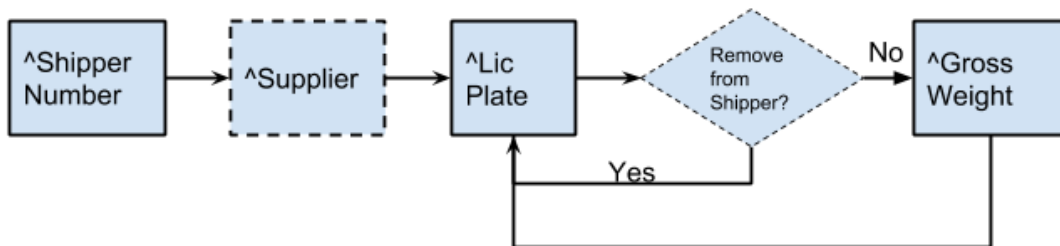

Field Information

Field Name	Comments
tt...	
^Shipper Number <i>(Data entry field)</i>	Input/scan/look up Shipper Number. Validate: <ul style="list-style-type: none"> Valid sub-contract shipper. Shipper must be unconfirmed. Blank entry is allowed. Look-up Purpose: Select the shipper number for the sub-contract PO or create a shipper number. Look-up Name: Sub-Shippers Query Rules: <ul style="list-style-type: none"> Domain = login domain Site = login site Shipper number is not confirmed Look-up Fields: <ul style="list-style-type: none"> ID: Shipper ID (Sort 2nd ascending) Sup: Supplier number (Sort 1st ascending)
^Supplier <i>(Data entry field)</i>	Input/scan/look up Supplier. Conditional field. Validate: <ul style="list-style-type: none"> Supplier number exists Supplier is in a valid domain Look-up Purpose: Select the supplier for the sub-contract shipper. Look-up Name: Suppliers Query Rules: <ul style="list-style-type: none"> Domain = login domain Site = login site Look-up Fields: <ul style="list-style-type: none"> Sup: Supplier Number (Sort 1st ascending) Name: Supplier name
Shipper	Defaults from a previous frame.
Ship To	Defaults from a previous frame.
^Lic Plate <i>(Data entry field)</i>	Input/scan/look up License plate. Validate: <ul style="list-style-type: none"> Lic Plate number exists Lic Plate not already on confirmed shipper Look-up Purpose: Select the License Plate for the sub-contract shipper. Look-up Name: License Plate Query Rules: <ul style="list-style-type: none"> Domain = login domain Site = login site Supplier = supplier entered Look-up Fields: <ul style="list-style-type: none"> License Plate (Sort 2nd ascending) Item Number Quantity Selected (Sort 1st ascending): Yes/No indicates if the license plate is selected on the specified shipper.

Field Name	Comments
Remove from shipper? <i>(Data entry field)</i>	Yes/No. Conditional field.
Total Weight	Defaults from a previous frame.
Gross Weight <i>(Data entry field)</i>	Input/scan gross weight.

Troubleshooting

Issue/Error	Root/Solution
<p>This error occurs when the gross weight entered for the container is less than the standard weight for the item and container.</p> 	<p>Enter the correct weight</p>

Pre-Shipper Convert to Shipper

This transaction allows users to convert a Pre-Shipper to a Shipper for both SO and DO Pre-Shippers.

Transaction Technical

DC Menu	DC Menu Name	DC Transaction Technical Name	Production Order .NET Menu Action
7.1.7	Outbound Shipment	Pre-Shipper Convert to Shipper	Trans: Pre-Shipper Convert - Parent App: PreShipper/Shipper Print (7.9.4, rcrp13.p)

Limitations / Exceptions

For the SO Pre-Shipper Convert to Shipper, we have designed the behavior of this transaction differently than the behavior in standard product. In standard product, when a pre-shipper is converted to a shipper, the pre-shipper is always deleted, even in cases where there are unpicked quantities remaining on the pre-shipper.

This transaction is designed to move the picked LPs from the source pre-shipper to a shipper. Any unpicked quantity will remain on the original pre-shipper. If the source pre-shipper has no remaining quantity to pick, then the source pre-shipper will be deleted.

Minimum System Setup

To enable the logic that retains a SO pre-shipper if it is not fully picked when it is converted to a Shipper, create a code master setup for the “Remove Pre-Ship flag”:

- Code Field Name: DC_Remove_PreShip
- Code value: <ShipFrom>
- Code Comment: Yes/No (keep No if pre-shipper is not to be removed/maintain with partial qty)

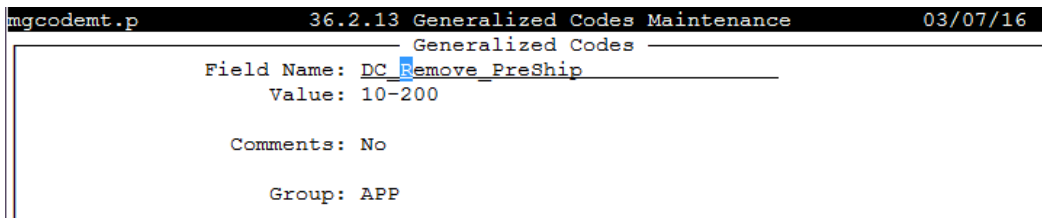

Minimum Data Required

N/A

Transaction Flow Chart

Fig. 4.7
Pre-Shipper Convert to Shipper

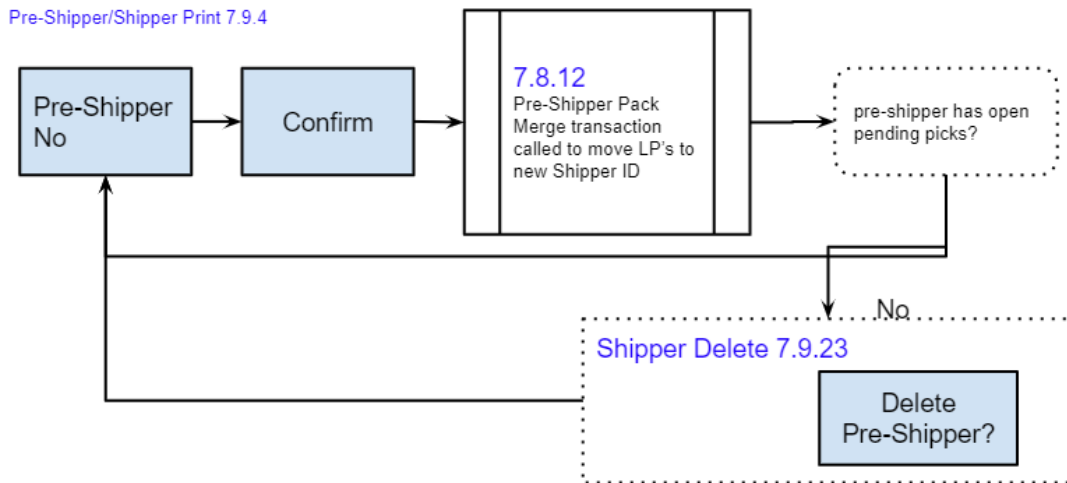

Field Information

Field Name	Comments
	dttpreshpcnv, disdttpreshpcnv, ttpreshpcnv - Pre-Shipper Convert
Last Pre-Ship	Last Scanned Pre-shipper Number
New Shipper	New Shipper Number created for Pre-Shipper Number
Last Ship To	Last Shipper's Ship To address
Cust Name	Last Customer Name
Pre-Ship (Data entry field)	<p>Input/scan/look up Pre-Shipper Number.</p> <p>Validation:</p> <ul style="list-style-type: none"> • Pre-Shipper exists • Pre-Shipper has at least one picked serial <p>Note: ID = Pre-Shipper IDs</p> <p>Look-up Name:</p> <p>Auto-display:</p> <p>Default Selected Values:</p> <p>Look-up Query Rules:</p> <ul style="list-style-type: none"> • Display only Pre-Shippers that are non-confirmed. • Pre-shipper that have some picked serials. If not, then they are not displayed. • Ship-from Site = Login Site • For the SO version, display only Shipment Type = P • For the DO version, display only Shipment Type = D <p>Look-up Fields:</p> <ul style="list-style-type: none"> • Pre-Shipper number (Sort ascending) • Ship-To • Ship-Date • Customer Name
Ship-To	Defaults from the Pre-Shipper Number
Ship Date	Defaults from the Pre-Shipper Number
Cust Name	Defaults from the Pre-Shipper Number
Pend Pick (Hidden)	If open pending picks are required, display "Yes".
Confirm (Data entry field)	User is prompted to review and confirm the pre-shipper number.

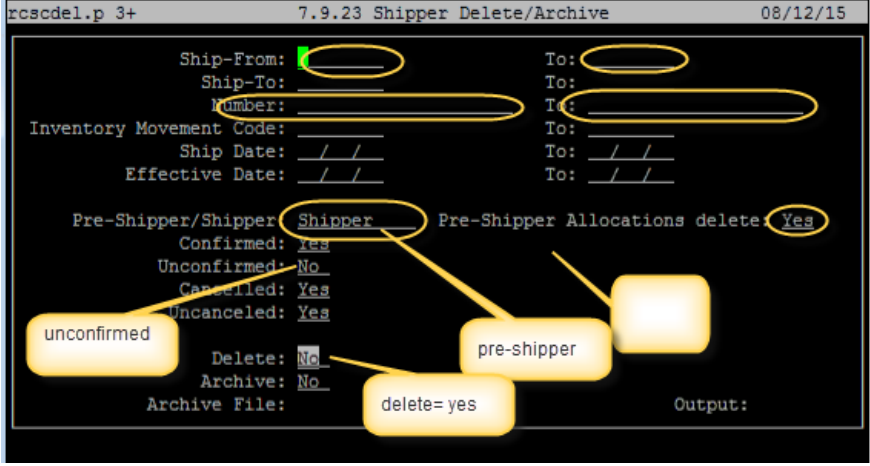
Field Name	Comments
Delete Pre-Shipper? (Data entry field)	<p>Conditional prompt: If zero open QTY on source pre-shipper, prompt user if they wish to delete source pre-shipper.</p> <ul style="list-style-type: none"> • Yes = deletes source pre-shipper • No = does not delete source pre-shipper  <p>Note: When the Delete flag is set to Yes in GCM, it will delete the pre-shipper that has a pending pick quantity and will create new shipper for the picked quantity. For this functionality, Pre-Shipper Convert version 20121.0003 will be linked to the parent transaction. When Delete flag is set to No (or Blank) in GCM, it will only move the pre-shipper to shipper for the picked quantity and it will not delete the pre-shipper record having the pending pick quantity. For this functionality, Shipper move version 20121.0001 transaction is created. A new parent transaction, Pre-shipper convert link will be created for this requirement.</p>
	After the user commits, display the last Pre-Shipper, the New Shipper and the Last Ship to.

Truck Load

Use this transaction to validate that the content loaded into the truck matches the Shipper. It provides a simplified approach to the Truck Load process and it supports both SO and DO.

Transaction Technical

DC Menu	DC Menu Name	DC Transaction Technical Name	Production Order .NET Menu Action
7.1.8	Outbound Shipment	Truck Load	Trans: Truck Load App: Truck Load (7.8.4, patrkld.p)

Limitations / Exceptions

- Sub-Plate logic not supported
- Does not support Sub-Contract

Minimum System Setup

N/A

Minimum Data Required

N/A

Transaction Flow Chart

Fig. 4.8
Truck Load

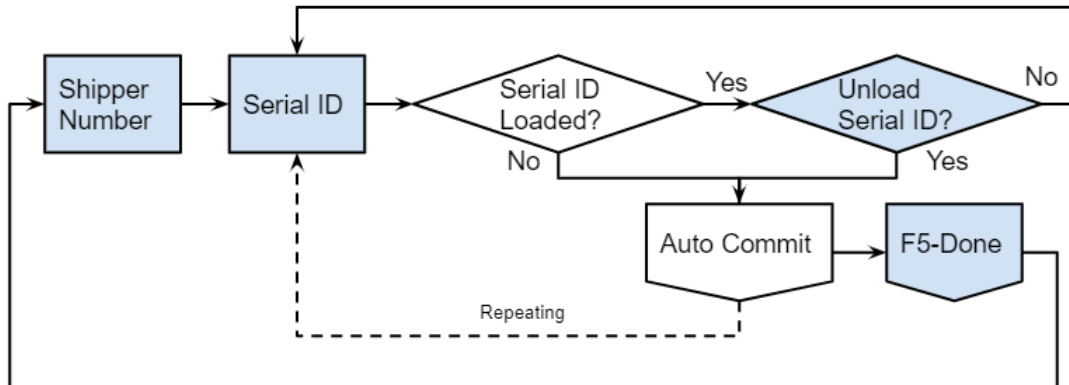

Field Information

Field Name	Comments
ttShipperToLoad, ttSerialToLoad - Truck Load	
Shipper Number (Data entry field)	Scan/input Shipper Number to load.
Customer	Defaults from the Shipper Number.
Name	Defaults from the Shipper Number.
Pallets	Defaults from the Shipper Number.
Loaded	Displays the count of loaded pallets. Otherwise, a Blank is displayed if no pallets are loaded.
Last Load	Defaults the last Serial ID entered.
Last Unload	Defaults the last unloaded Serial ID.
Serial ID (Data entry field)	Scan/input the Serial ID on the Shipper to load. The Unload prompt appears if the user enters a Serial ID that is already loaded.

Sub-Plate Logic

The following is from a functional document:

- Follow the same logic to find if a scanned Serial contains the corresponding usrw_wkfl record.
- Then check if the LP is already loaded based on usrw_logfld[i] field.
- If it was already loaded and scanned again, prompt for unload confirmation.
- If user confirms, update the usrw_wkfl record (usrw_logfld[i] as no).
- Even if one LP is scanned for unload, check for the corresponding ser_mstr record to see if it was updated as truck loaded. If yes, then update the ser_mstr as truck unloaded.
- Ensure the serial history is updated with the truck unload transaction.

Labels

With the above example, the SubPlates License ID will be printed as below

Label Count	User Scan
First Label	1028068
Second Label	1028068.01
Third Label	1028068.02
Fourth Label	1028068.03
Fifth Label	1028068.04
Sixth Label	1028068.05
Seventh Label	1028068.06
Eighth Label	1028068.07
Ninth Label	1028068.08

Truck Load Change

The changes below are specific to the SubPlate scan process. All other functionality remains the same.

- 1 Allow the user to scan the shipper.
- 2 Allow the user to scan the LP.
 - Check if the LP has a ‘.’ (period).
 - If yes, remove the period and value after it using a memory variable. For example, if the scanned value is 100001.01, then change the value to 100001.

- 3 Check if the LP record is available in usrw_wkfl

Usrw_domain = global_domain | usrw_key1 = ‘SubPlates’ and usrw_key2 = <Serial Id>

If record is not available, then business as usual.

If usrw_wkfl record is found, then perform the following:

- Update usrw_logfld
- In the above mentioned label example (1028068 - 1028068.08)

User Scan	Update Record
1028068	usrw_logfld[1]
1028068.0	usrw_logfld[2]

Troubleshooting

Issue/Error	Root/Solution
<p>User cannot enter Pre-Shipper in Shipper Number field. Truck Load</p> <div data-bbox="231 380 742 636" style="border: 1px solid black; padding: 5px;"> <p style="text-align: center; background-color: black; color: white; margin: 0;">Messages</p> <pre style="font-family: monospace; margin: 0;">>MFG-10801 ERROR: Invalid Shipper. Please re-enter.</pre> <p style="text-align: center; background-color: black; color: white; margin: 0;">< OK ></p> </div> <p>F2-Look F4-Back F5-Done F10-Abort</p>	<p>Create a Shipper in Pre-Shipper/Shipper Print (7.9.4) or Pre-Shipper/Shipper Workbench (7.9.2).</p>

DO Shipper Confirm

Use this transaction to confirm a DO Shipper.

Transaction Technical

DC Menu	DC Menu Name	DC Transaction Technical Name	Production Order .NET Menu Action
7.1.9	Outbound Shipment	DO Shipper Confirm	Trans: DO Pre-Shipper-Shipper Confirm App: DO Pre-Shipper/Shipper Confirm (12.19.13, dodsois.p)

Limitations / Exceptions

N/A

Minimum System Setup

N/A

Minimum Data Required

N/A

Transaction Flow Chart

Fig. 4.9
DO Shipper Confirm

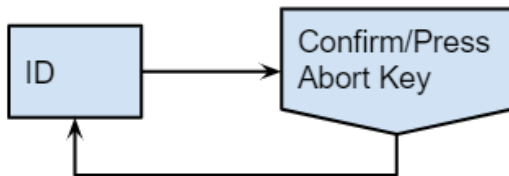

Field Information

Field Name	Comments
ttDODummy, ttDOTrans - DO Pre-Shipper-Shipper Confirm	
ID <i>(Data entry field)</i>	Input/scan/look up Pre-Shipper or Shipper Number. Look-up Name: Auto-display: Default Selected Values: Look-up Query Rules: Display Distribution Order Pre-Shippers and Shippers with Type = P or S. Look-up Fields: <ul style="list-style-type: none"> • Ship-To (Sort 1st ascending) • ID (Sort 2nd ascending) • Type
Ship-To	DO Ship-To defaults from Pre-Shipper or Shipper.
Hidden field default values	<ul style="list-style-type: none"> • Ship-From ID = log-in site • Find Ship-To based on the Pre-Shipper/Shipper selected. • Set the Ship Date = today. • Set the Effective Date = today. • Suppress 'WARNING: Shipper not printed' • Skip "vehicle" section (Vehicle ID, Ship Time, Arrive Date, Arrive Time) • Set Calculate Freight = yes. • ID refers to Pre-Shipper/Shipper Number • Type [P or S] is abbreviation for Pre-Shipper or Shipper
Name	DO Ship-To Name defaults from Pre-Shipper or Shipper.
Confirm / Press Abort Key <i>(Data entry field)</i>	Enter to confirm transaction or press F10 (Abort) to leave.

Shipment Modify

Move Pack between Shipper

This transaction allows users to:

- Remove a pack (License Plate) and move it to another Pre-Shipper/Shipper (DO and SO).

- Scan one or more LPs, select the source Shipper, and move them to a destination Pre-Shipper/Shipper.
- Create a new Destination Pre-Shipper on demand.

This transaction supports users located in a shipping office or on the shipping dock.

Transaction Technical

DC Menu	DC Menu Name	DC Transaction Technical Name	Production Order .NET Menu Action
7.2.1	Shipment Modify	Move Pack between Shipper	Trans: Move Pack Between Pre-Shippers - Parent App: Linked Transactions
7.2.1.1-1	Shipment Modify	Linked	Trans: Move Pack Between Pre-Shippers - SO App: Move Pack Between (Pre)Shippers (7.8.12, pasoshmv.p)
7.2.1.1-2	Shipment Modify	Linked	Trans: Move Pack Between Pre-Shippers - DO App: Move Pack Between (Pre)Shippers (12.9.12, padoshmv.p)

Limitations / Exceptions

- To validate with TMS Rating, contact QAD Services for assistance.
- The Serial ID limits the Pre-Shipper/Shippers that are available to Move to those with same Ship-To.
- This transaction is only configured to move packs between Shippers.
- The Move All License Plates prompt/functionality is not available.

Minimum System Setup

N/A

Minimum Data Required

The Pack (LP) that is being moved must have Stage = Picked.

Transaction Flow Chart

Fig. 4.10 Move Pack Between Shipper

Shop Floor Flow

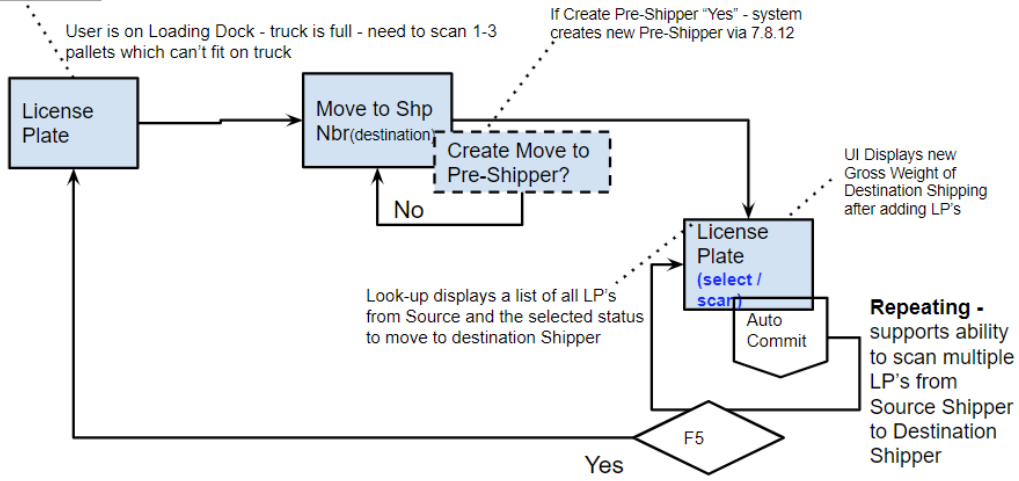

Field Information

Field Name	Comments
tt...	
Mp License Plate <i>(Data entry field)</i>	Input/scan Serial ID of License Plate to move. Additionally, the system will find the source pre-shipper/shipper. Key Assumption: Users will start by scanning the LP and not start with the Pre-Shipper/Shipper.
tt...	
License Plate Mp LicP	Redisplay from prior buffer.
Move From	Defaults from the Pre-Shipper/Shipper Serial ID.
Customer	Customer Name of Shipper
^Move to Shipper Nbr <i>(Data entry field)</i>	Input/scan the Pre-Shipper/Shipper to move the pack to. Look-up Purpose: Look-up Name: Auto-Display: Look-up Query Rules: <ul style="list-style-type: none"> • Display the pre-shippers/shipper with the same Ship-to as the selected Serial ID. • DO version only displays DO shippers. • SO version only displays SO shippers. Look-up Fields: <ul style="list-style-type: none"> • Move to Nbr (Preshipper/Shipper) (Sort ascending) • Rated (Yes/No) • Customer Name • Ship-To

Field Name	Comments
Create Move to Pre-Shipper? (Conditional) (Data entry field)	Conditional field Purpose: If there is no pre-shipper to move LPs to, the user can create a new pre-shipper abs_type “p” on demand. Prompts user: If YES, then Pre-Shipper is created. If NO, the user is returned to prior field.
Gross Weight	Displays the original gross weight of Move to Shipper Nbr.
^Mp LicP (Data entry field)	Select/Scan the License Plates to move to destination pre-shipper/shipper. Look-up Purpose: Look-up Name: Auto-Display: Look-up Query Rules: Display all Serial IDs with Status = Picked. Look-up Fields: <ul style="list-style-type: none"> Serial ID (Sort 2nd ascending) Move From Nbr (Preshipper/Shipper) (Sort 1st ascending) Ship-To Look-up Purpose: Look-up Name: Auto-Display: Query Rules: Display all Serial IDs Per SELECTED Source Pre-Shipper/Shipper Look-up Fields: <ul style="list-style-type: none"> Serial ID (Sort 2nd ascending) Selected to Move (Sort 1st descending): This field is updated to display “YES” when the Serial ID has been selected to move to the new pre-shipper.
^Item List	User has ability to examine the Items on the Serial ID by pressing F2 when this field is prompted. Does not take input. Does not appear as a display field Look-up Purpose: Look-up Name: Auto-Display: Query Rules: Display all Items on previously selected Serial ID. Look-up Fields: <ul style="list-style-type: none"> Item (Sort ascending) Description
F5 Done	When user is done, press F5 to commit changes.

Programs

Program	Procedure
dcengxr.p	setEventFlag, setFieldValue, setBufferFlag
pasdxr.p	getShipperBySerialId, getShipperIDBySerialID
dcmspxr.p	findShipper, createShipperforDC, isValidShipper
destdxr.p	getRepValue, ValueIsBlank, getRepValue
APIDispatcher.p	dcProcessAPI
pafunc.p	isUnitPack

Troubleshooting

Issue/Error	Root/Solution
<p>Move Pack - start with LP</p> <div style="border: 1px solid black; padding: 5px; margin: 10px 0;"> <p style="text-align: center; background-color: black; color: white; margin: 0;">Messages</p> <pre style="margin: 0;">>DC-8229 ERROR: Invalid order ship-to.</pre> <p style="text-align: center; background-color: black; color: white; margin: 0;">< OK ></p> </div> <p>F2-Look F4-Back F5-Done F10-Abort</p>	<p>The user receives this error message if the Pre-Shipper/Shipper Ship-To of Move To Nbr is different than the Ship-To associated with the Serial ID. Users can only move a pack between Pre-Shipper/Shipper with same Ship-To.</p>

Pack Merge

Use this transaction to merge License Plates and Packs within a (Pre) Shipper. This transaction allows users to:

- Merge an item or pack serial ID to a pack serial ID.
- Merge an active pack to another active pack with the same item/lot.
- Merge a picked pack to another picked pack without restrictions.

Both SO and DO are supported.

Transaction Technical

DC Menu	DC Menu Name	DC Transaction Technical Name	Production Order .NET Menu Action
7.2.2	Shipment Modify	Pack Merge	Trans: Pack Merge App: 3.17.15 papamg.p

Limitations / Exceptions

This transaction is designed for unit pack processing.

Minimum System Setup

N/A

Minimum Data Required

N/A

Transaction Flow Chart

Fig. 4.11
Pack Merge

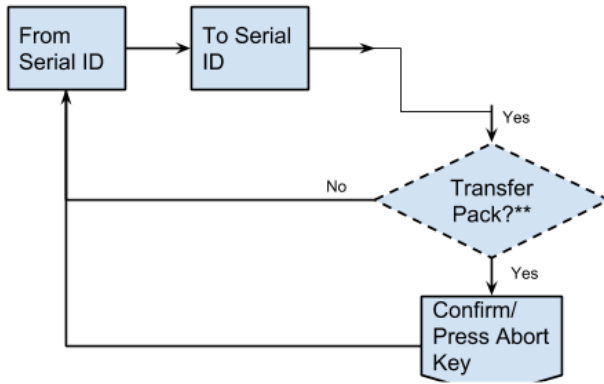

Set all optional prompts to Yes. If valid From/To serials entered, go to Confirm prompt.

*Conditional: User only prompted if From and To IDs belong to different Pres/Ship

**Conditional: User only prompted if From and To IDs are in different Site/Location

Field Information

Field Name	Comments
tt...	
^From ID (Data entry field)	Input/scan/look up Serial ID to merge From. Validations: Serial ID exists and has Stage = Active or Picked. Look-up Fields: <ul style="list-style-type: none"> • From ID • Stage • Location • PreS/Ship
Stage	Defaulted
Location	Defaulted
PreS/Ship (Data entry field)	Defaulted Validation: Logical input (Yes/No). Note: The user receives a message if the From/To Serial IDs are on different Pre-Shippers or Shippers.

Field Name	Comments
^To ID <i>(Data entry field)</i>	Input/scan/look up Serial ID to merge To. Validation: <ul style="list-style-type: none"> Serial ID exists and has Stage = Active or Picked. Does not equal serial ID entered in From Serial ID. If active stage, serial must have same item/lot as From Serial ID. Look-up: Query Rules: <ul style="list-style-type: none"> Display Serial IDs with Stage equal to From ID Stage. If active stage, display serials with same item/lot. Do not display the serial entered in From ID. Look-up Fields: <ul style="list-style-type: none"> Serial ID Item Stage Site Location PreS/Ship
Stage	Defaulted
Location	Defaulted
PreS/Ship	Defaulted
Transfer Pack? <i>(Data entry field)</i>	Logical input (Yes/No) Note: The user receives a message if the From/To Serial IDs are in a different Site/Location.
Confirm/Press Abort Key <i>(Data entry field)</i>	Logical input (Yes/No) Display From ID, Stage (From), Location (From), PreS/Ship (From), To ID, Stage (To), Location (To), PreS/Ship (To) Note: If user selects Yes, commit transaction. If user selects No, return user to Field 1 From ID without committing.

Shipper LP Weight Modify

Use this transaction to modify the gross weight of a License Plate (pack/pallet), to modify the weights of License Plates in (Pre)Shippers, and to reprint labels.

Transaction Technical

DC Menu	DC Menu Name	DC Transaction Technical Name	Production Order .NET Menu Action
7.2.3	Shipment Modify	Shipper LP Weight Modify	Trans: Shipper Data Maintenance App: Shipper Data Maintenance (7.8.6, patrkwt.p) Linked Trans: License Plate Label Version

Limitations / Exceptions

Users cannot enter a negative number.

Minimum System Setup

N/A

Minimum Data Required

The License Plate must have Stage = Picked or Consumed.

Transaction Flow Chart

Fig. 4.12
Shipper LP Weight Modify

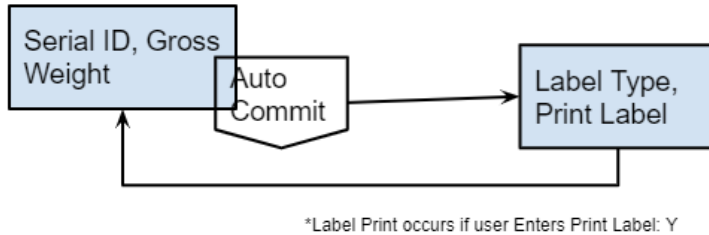

Field Information

Field Name	Comments
ttSerial - Shipper LP Weight Modify	
Serial ID <i>(Data entry field)</i>	Input/scan Serial ID of pack to modify weight.
Item	Defaults from the Serial ID.
Pack Qty	Defaults from the Serial ID.
Net Wt	Defaults from the Serial ID.
Tare Wt	Defaults from the Serial ID.
Gross Weight	Displays the sum of the net and tare weight. The user can enter a new value to modify gross weight.
Linked Transaction Detail - License Plate Label	
ttSerial - License Plate Label	
LP ID	Defaults from Frame 1
Label Type <i>(Data entry field)</i>	Input/look up Label Type to print.
Print Label <i>(Data entry field)</i>	Defaults to YES. The user can enter N to prevent Label Print.

Programs

Program	Procedure
patrkai.p	runAPIForWeightUpdate
dccalltran.p	
pasexr.p	getSiteLocation

patkldxr.p	isPackValidForTruckLoad
pasdxr.p	calculatePackWeight
pasexr.p	getSerialStage
dcengxr.p	setFieldValue
pasexr.p	calculateItemQty
gpmathxr.p	ValidateForNegativeQty
dcengxr.p	setVariable
dcengxr.p	setEventFlag

Troubleshooting

Issue/Error	Root/Solution
<p>Shipper LP Weight Modify</p> <div data-bbox="233 716 746 974" style="border: 1px solid black; padding: 5px;"> <p style="text-align: center; background-color: black; color: white; margin: 0;">Messages</p> <pre style="margin: 5px 0;">>DC-11355 ERROR: Invalid serial ID.</pre> <p style="text-align: center; background-color: black; color: white; margin: 5px 0;">< OK ></p> </div> <p>F2-Look F4-Back F5-Done F10-Abort</p>	<p>The user receives this message if the Serial ID Stage = Active or Decommissioned. The License Plate weight can only be modified if the Stage = Picked or Consumed.</p>

Issue/Error	Root/Solution
<p>Shipper LP Weight Modify</p> <div data-bbox="233 306 751 569" style="border: 1px solid black; padding: 5px;"> <p style="text-align: center; margin: 0;">Messages</p> <pre style="margin: 0;">>DC-2046 ERROR: Invalid serial number.</pre> <p style="text-align: center; margin: 0;">< OK ></p> </div> <p>F2-Look F4-Back F5-Done F10-Abort</p>	<p>The user receives this message if a non-existent Serial ID is entered.</p>
<p>Shipper LP Weight Modify</p> <div data-bbox="233 743 751 1005" style="border: 1px solid black; padding: 5px;"> <p style="text-align: center; margin: 0;">Messages</p> <pre style="margin: 0;">>DC-12980 ERROR: Serial ID does not belong t o this shipper.</pre> <p style="text-align: center; margin: 0;">< OK ></p> </div> <p>F2-Look F4-Back F5-Done F10-Abort</p>	<p>The user receives this message if the Serial ID Stage = Booked. The License Plate weight can only be modified if Stage = Picked.</p>

Outbound

Shipper Labels

Use this transaction to reprint Shipper Labels for SO and DO order types. It allows users to print/reprint all (or specific) label groups for a shipper or a specific License Plate.

Transaction Technical

DC Menu	DC Menu Name	DC Transaction Technical Name	Production Order .NET Menu Action
7.2.4	Outbound	Shipper Labels	Trans Shipper Labels App: NA

Limitations / Exceptions

A sample label.

Minimum System Setup

N/A

Minimum Data Required

N/A

Transaction Flow Chart

Fig. 4.13
Shipper Labels

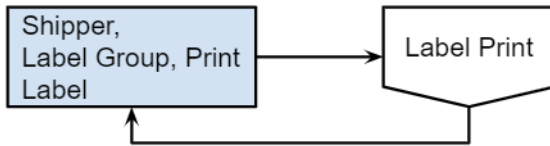

Field Information

Field Name	Comments
ttShipperPrint - Shipper Labels	
Ship-From	Defaults from Shipper
Shipper	Select from the Shipper auto-lookup.
Lbl Group <i>(Data entry field)</i>	Select from the Label Group auto-lookup.
LP ID <i>(Data entry field)</i>	Conditional if the Lbl Group is left blank. Select the LP to reprint.
Lbl Type <i>(Data entry field)</i>	Conditional if Lbl Group is left blank. Optional: Enter the specific Lbl Type to reprint or leave blank to print all. In the above transaction, the look-up logic for the Label Type field is trying to find "lbEvent" records by comparing the "eventID" field value against certain hard coded values (which are 'MpUpdate, MpDest, MpCntr, MpMixMstr, MpDetail'). If such records are found, they are displayed in the Label Type look-up.
<pre> Shipper Labels v2 Print Shipper Labels Ship-From: 101 Shipper: PD000038 Lbl Group: LP ID: 1031102 MpLp, MpDest, MpCntr, MpMixMstr, MpDetail ^Lbl Type </pre>	
printLabel <i>(Data entry field)</i>	Defaults to Yes. Enter N if user wants to cancel label print.

Programs

Program	Procedure
lblstdxr.p	createLPSWorkFileRecord
lblstdxr.p	deleteLPSWorkFileRecord
dcengxr.p	logicalVariableValue
dcengxr.p	setEventFlag
dcengxr.p	setFieldValue
dcengxr.p	setBufferFlag
dcengxr.p	getVariableValue
dcshpxr.p	findShipper
dcstdxr.p	getRepValue
dcshpxr.p	isValidShipper
pasdxr.p	isSerialIDLinkedToGivenShipper

Label Printing Setup Reference

The following information shows how the solution is configured in a QAD Demo environment. This is for reference only.

Note The following Label Events are hard coded:

- ShpMpAll
- ShpMpReprint
- ShpMpBol

The following example shows the setup for “ShpMpAll”.

- 1 Specify the correct Extraction program. In the screenshot below, `xxtest1.p` is given as a sample.

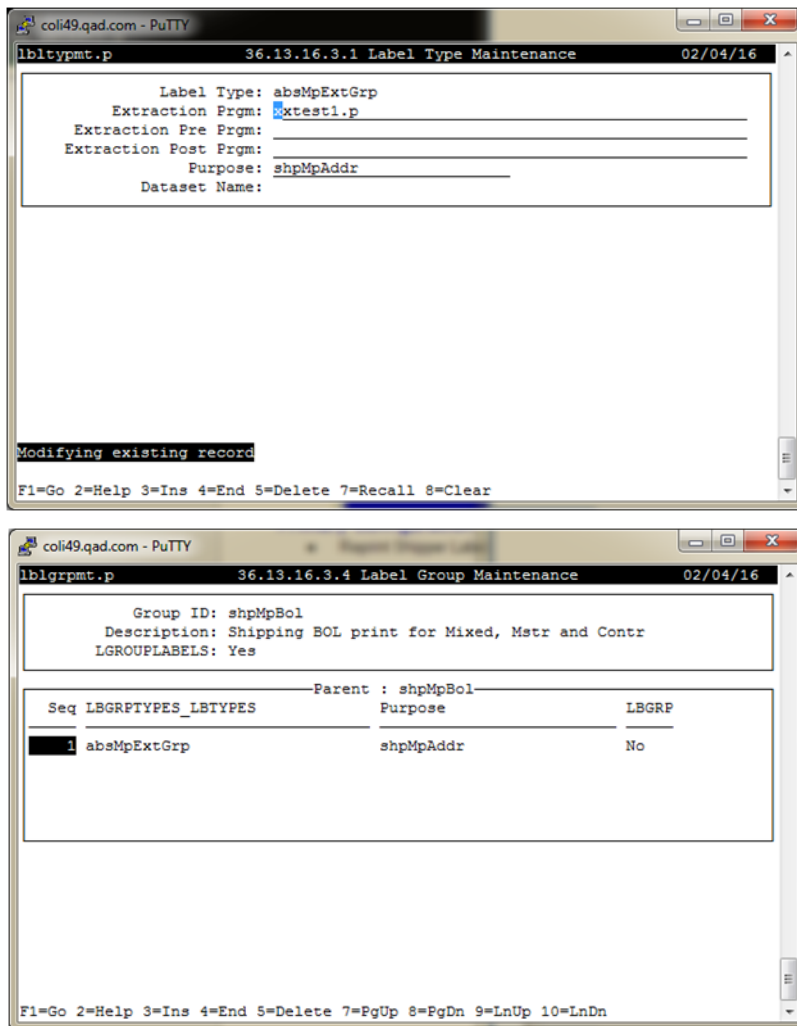

- 2 Enter the following Join Phrase:

```
first ad_mstr where ad_domain = abs_domain and ad_addr = abs_shipto
```

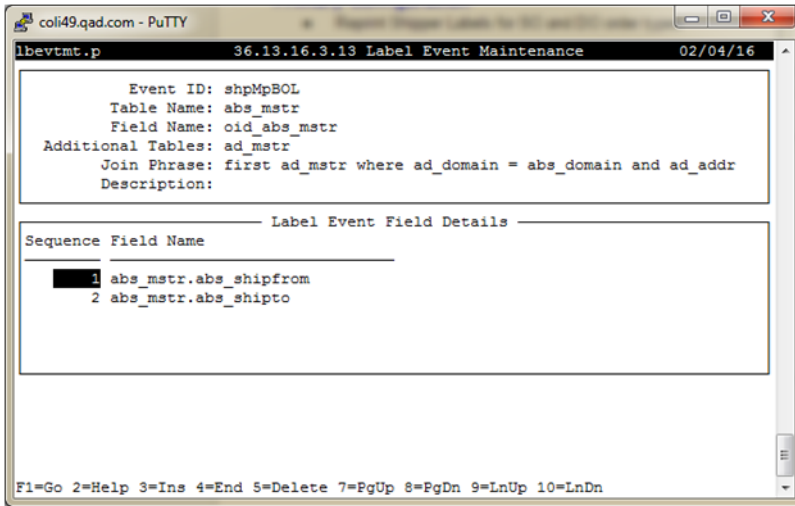

Shipper Item Label

This transaction, which is focused on customer item labels, is used to print/reprint Item Labels on a Shipper.

Transaction Technical

DC Menu	DC Menu Name	DC Transaction Technical Name	Production Order .NET Menu Action
7.2.5	Outbound	Shipper Item Label	Trans: Customer Item Label App: NA

Limitations / Exceptions

A sample label.

Minimum System Setup

N/A

Minimum Data Required

N/A

Transaction Flow Chart

Fig. 4.14
Shipper Item Label

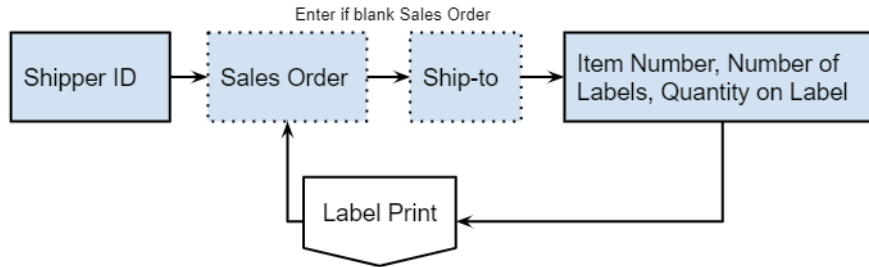

Field Information

Field Name	Comments
CItem - Customer Item Label	
Shipper ID <i>(Data entry field)</i>	Optionally enter the pre-shipper/shipper for the SO or DO orders. Look-up: Use the same look-up as found in the Shipper Print transaction.
SO <i>(Data entry field)</i>	Prompt user if the Shipper is blank. Input/scan/look up Sales Order. User can enter Blank and bypass to Ship To.
ShipTo <i>(Data entry field)</i>	If a Sales Order was entered, this defaults from the SO. If SO is Blank, input/look up Ship To.
Item <i>(Data entry field)</i>	Input/scan/lookup Item number.
Nbr of Lbl <i>(Data entry field)</i>	Input number of labels to print.
Quantity on Label <i>(Data entry field)</i>	Input number of Items on Label.

Programs

Program	Procedure
dcengxr.p	setEventFlag
	SetFieldValue
	getVariableValue
lblstdxr.p	createLPSWorkFileRecord
lblstdxr.p	deleteLPSWorkFileRecord
dcmspxr.p	findShipper

License Plate Label

Use this transaction to print/reprint all (or specific) label groups for a specific License Plate.

Transaction Technical

DC Menu	DC Menu Name	DC Transaction Technical Name	Production Order .NET Menu Action
7.2.6	Outbound	License Plate Label	Trans: License Plate Label App: NA

Limitations / Exceptions

A sample label.

Minimum System Setup

N/A

Minimum Data Required

Open discrete or scheduled order

Transaction Flow Chart

Fig. 4.15
License Plate Label

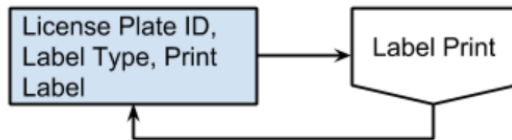

Field Information

Field Name	Comments
tt...	
LP ID <i>(Data entry field)</i>	Input/scan/look up License Plate ID.
Label Type <i>(Data entry field)</i>	Input/look up Label Type.
Print Label <i>(Data entry field)</i>	Defaults to Yes. Enter N to cancel label print.

Production Order Transactions

This chapter includes detailed technical information for the Automation Solutions: Data Collection Production Order transactions.

Introduction 142

Production Order Menu 142

Production Order Transactions 143

Introduction

When you use QAD Automation Solutions: Data Collection with production orders, you are provided a unique set of Data Collections-built transactions that specifically function with QAD Production Orders.

You can use Data Collection development tools to customize the transactions so that they provide the transaction flow, UI layout and fields, and data validations that the business requires for production orders.

The transactions—used in receiving, production, shipping, inventory management, and more—are processed in connection with a QAD server that provides Data Collection, data validation, and error handling during transaction processing and line-by-line or unit posting of the RF transactions in real time.

Note This chapter describes the following transactions that are available with production orders. Some transaction descriptions include a technical flow that depicts sample screens when the transaction displays on a hand-held device.

- Material Request
- Material Pick-Transfer-Issue
- Material Transfer
- Material Issue
- Production Packaging
- Production Receipts
- Production Item Putaway

Production Order Menu

You can access transactions for production orders through the Production Order menu on your mobile radio frequency (RF) device or other device. Once you enter the correct login data, navigate to the screen shown in Figure 5.1.

Fig. 5.1
Production Order Menu



Production Order Transactions

This section discusses the following Production Order transactions.

- Material Request
- Material Pick-Transfer-Issue
- Material Transfer
- Material Issue
- Production Packaging
- Production Receipts
- Production Item Putaway

Material Request

Material Request covers the following areas of event-driven signals:

- Pull: Includes signals for line side, kanban, and min/max
- Dynamic push: Includes signals coming from production schedules (via the workbench)
- Formal push: Includes signals from picklists

This single transaction covers the following replenishment solutions:

- Picking any inventory combination of item, lot/serial, or packaged goods
- Picking full or partial packs, pack splits, or kitting

The transaction dynamically factors rules for item allocation, transfer and issue policies, and delivery locations.

The following graphic depicts various sources of replenishment signals, including line-side direct signals; kanban signals; and workbenches-driven resource replenishment through pick and transfer functions.

Fig. 5.2
Replenishment Signals Overview

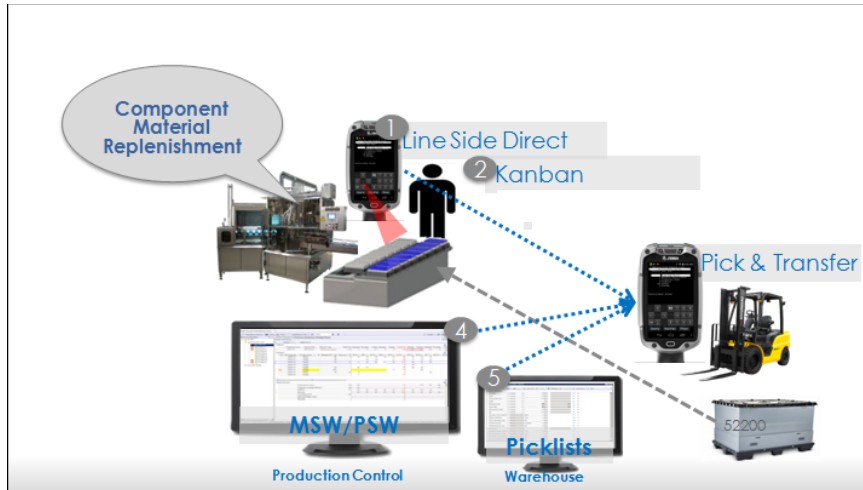

Primary Configuration

The Material Pick-Transfer-Issue transaction includes:

- Line-side replenishment request: A user-created request to move inventory to a location
- Line-side replenishment delivery: A per-line-side replenishment request that indicates warehouse inventory required to move to a specific location

The system creates a record for the line-side replenishment request when users scan the location, item number, and quantity. Once scanned, the system stamps the record with the date, time, and user name.

Using input from the line-side replenishment request, the system indicates the warehouse inventory required to move to a specific location in the line-side replenishment delivery transaction.

For the line-side replenishment delivery, the system creates a DC workfile as a result of this transaction with the location, item, quantity, date, time, user, and priority.

Minimum System Setup

You must install and enable QAD Serialization to pick by a serialized pack. For information on installing the correct version of QAD Serialization with the Production Orders version you use, refer to the *QAD Production Orders Installation Guide* for your version.

Transaction Technical

DC Menu	DC Menu Name	DC Transaction Technical Name	Production Order .NET Menu Action
5.1.1	Production	Material Request	Trans: Production Order Replenishment Request App: Inventory Transfer (3.4.3, iclotr03.p)

Transaction Flow

The following graphic depicts the overall flow of the Material Request transaction.

Fig. 5.3
Line Side Replenishment Request (Parent)

Line Side Replenishment Request (Parent)

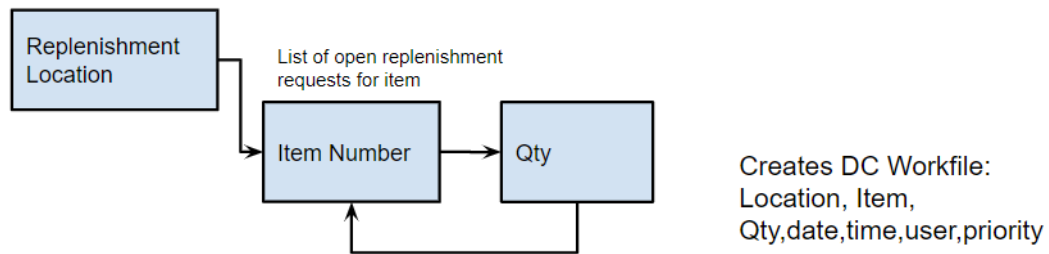

The following graphics depict the production replenishment flow. Request signals can emanate from resource replenishment, production orders, picklists, kanban, or min/max amounts. Not all screens display—only those that represent major replenishment functions

Fig. 5.4
Material Request Replenishment Flow

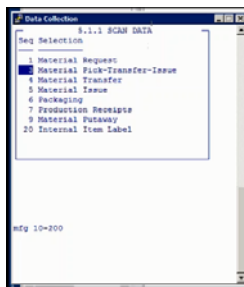
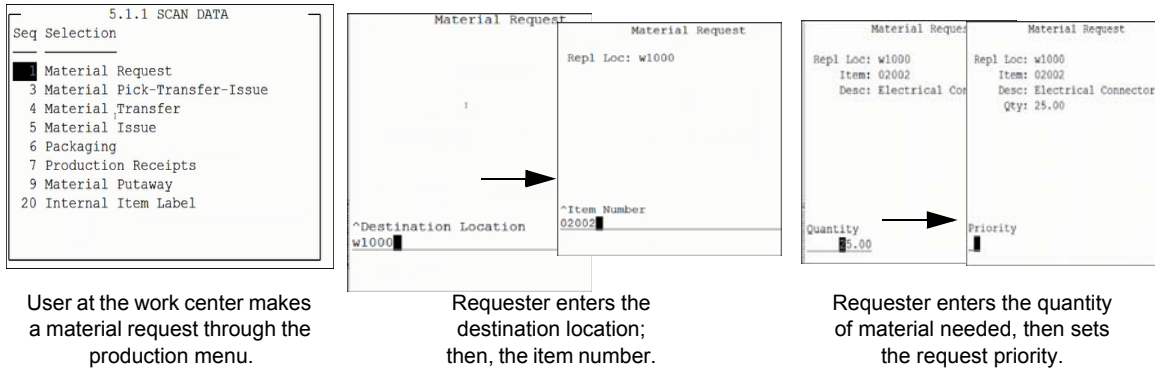

Actual replenishment is through the Material Pick-Transfer-Issue transaction.

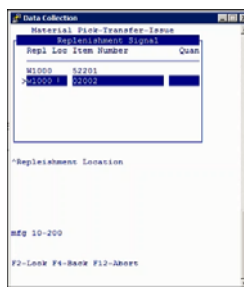

User selects the line-side replenishment request and presses F2 to see more details on request signals.

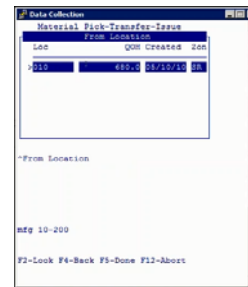

User selects or enters the From location.

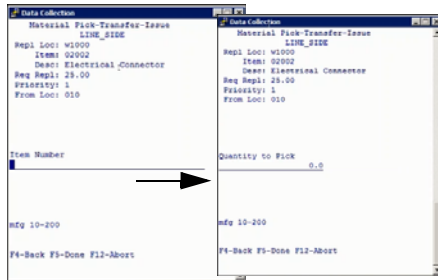

User enters the item number, and the quantity to pick; then, presses Go.



Item transferred.

The following graphic depicts another type of replenishment through a kanban card. When the card is scanned, the system creates a replenishment request.

Fig. 5.5
Kanban Replenishment Flow

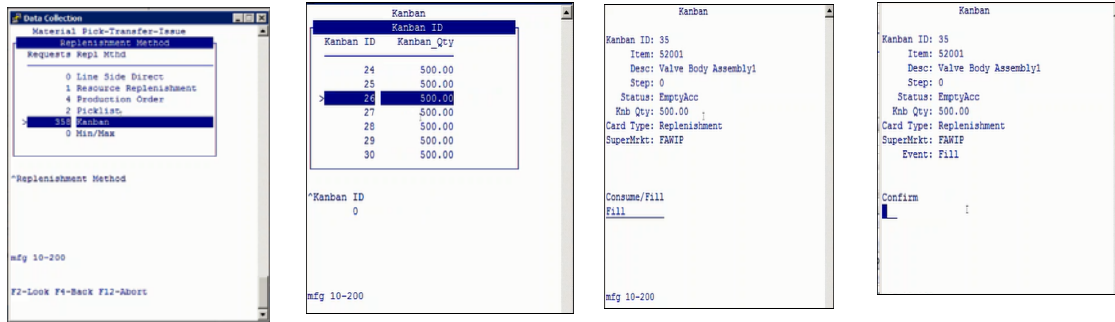

User selects the kanban replenishment.

User selects a kanban ID or presses F2 to select from existing IDs.

User enters either consume or fill.

User confirms replenishment.

Another replenishment option is when you schedule production through the workbenches and release the orders to signal replenishment. To replenish through this method, you use the Material-Pick menu option, then the resource replenishment option.

Limitations/Exceptions

N/A

Field Information

Field Name	Comments
tt... Line Side Replenishment Request (Parent)	
Destination Location <i>(Data entry field)</i>	Validation: Must be valid inventory location for user site log-in. Look-up Query Rules: Find all open DC workfile events created per all locations
Item Number <i>(Data entry field)</i>	Validation: Must be valid item per item master Look-up Query Rules: Find all open DC workfile events created per selected Location If user selects item where request already exists, Prompt User: Remove Request? Yes/No <ul style="list-style-type: none"> • If yes, remove DC workfile record for item/location • If no, prompt user for QTY and replace prior record with new DC work file record created
Description	Description of input/scanned item
QTY <i>(Data entry field)</i>	Enter quantity to replenish Default: 25

Field Name	Comments
Priority (Data entry field)	Default: blank Allow user to enter (1,2,3)
	Create DC workfile with the following information: dcWorkFile.LastModifiedUser = "LineReplUsr" dcWorkFile.AppDomain = "LineRepl" dcWorkFile.KeyField1 = <LoginSite > dcWorkFile.KeyField2 = <Replenish Location + Item Number > dcWorkFile.KeyField3 = <Replenishment Location > dcWorkFile.KeyField4 = <tem number> dcWorkFile.KeyField5 = <User ID> dcWorkFile.DecimalField = <Quantity to Replenish > dcWorkFile.IntegerField = <Priority> dcWorkFile.LastModifiedDate = <Created Date> dcWorkFile.LastModifiedTime = <Create Time >

Material Pick-Transfer-Issue

This transaction lets users issue materials to production. There are several methods to use when issuing, including picking, transferring, and issuing components.

This parent transaction manages all forms of production material picking and replenishment for production order functions and replaces prior EE 2016 and 2017 transactions related to material picking and issuing.

Material replenishment signals are generated from:

- Manual material requests
- Released production orders generates backflush location replenishment requests
- Release production orders - replenish by order
- Released production orders and generated picklists
- Backflush location Min/Max

Each replenishment method will support picking by item, lot/serial, pack.

- When picking by pack, each replenishment method will support picking partial packs, including pack splits, pack remove.
- Picking by order provides the ability to pick and kit.

The material replenishment methods appropriate for each implementation are influenced by the COMBINATION of:

- Item Allocation Policy Settings
- Backflush vs direct issue policies
- Loose inventory / Lot Controlled Inventory / Serialized Inventory

The following graphic shows a typical flow for this transaction. In the scenario that displays, some production order picklist materials are picked and issued to the order, while other materials are picked and transferred to the shop floor, before being backflushed to the production order.

Fig. 5.6
Material Issue Overview

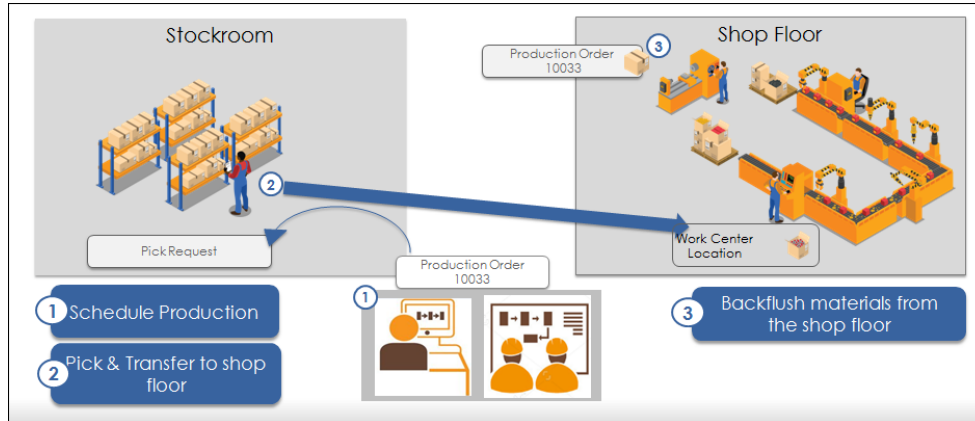

Primary Configuration

This transaction supports the following production order picklists:

- By Order
- By Picklist

The pick_hist history table captures picklist events.

Transaction Technical

DC Menu	DC Menu Name	DC Transaction Technical Name	Production Order .NET Menu Action
5.1.3	Production	Material Pick-Transfer-Issue	Trans: Production Order Pick-Transfer-Issue App: Several linked transactions called: <ul style="list-style-type: none"> • Pack Split (3.17.16, papasp.p) • Pack Remove (3.17.15, paparm.p) • Pack Build (3.17.3, papabd.p) • Pack Merge (3.17.15, papamg.p) • Pack Create by Pack Code (3.17.2, papacr01.p) • Production Order Manual Allocation (16.5.2, womall.p) • Production Order Picklist Pick by Item (16.5.7, wopkpp.p) • Production Order Picklist Pick by Pack (16.5.7, wopkpp.p) • Production Order Picklist Transfer (16.5.9, wopkis.p) • Production Order Picklist Issue by Item (16.5.11, woispck.p) • Production Order Picklist Issue by Pack (16.5.11, woispck.p) • Production Order Component Issue by Pack (16.5.12, woisord.p) • Production Order Component Issue by Item (16.5.12, woisord.p) • Kanban Consume/Fill (17.6.1, kbtr1.p) • Inventory Transfer (3.4.3, iclotr03.p) • Pack Transfer (3.17.8, papatr02.p)

Limitations/Exceptions

API does not support issuing from a pack where multiple items/lots exist.

Line Side Replenishment Request (Parent)

- **Transfer to Backflush Locations.** The system does not support backflushing components from a pack; therefore, all transactions are configured to automatically decommission a transferred pack to a production line and work center backflush location.
- **Production Order Manual Allocations.** Does not support the ability to update the picked QTY, as legacy 16.13.1 provided; therefore, the kitting solution uses the Allocation QTY field to indicate the “picked” field. This limits the ability for a component to detail allocate and pick material at the same time in this scenario.
- **Pack Split.** Does not support ability to move material to destination pack without it being in same location of material being picked. Workaround: Perform a pack remove and then use pack build.
- **Multi-Item Packs.** Picking packs containing multiple items/lots not currently supported by .NET or Automation Solutions.

Replenishment Method - Line Side Direct

- The system processes user's line side replenishment requests for the user's log-in site.

Replenishment Method - Resource

- Site must be the user log-in site.
- Production order demand must exist for Order Types Discrete and S.
- Status must be E, A, or R.
- Release Date must be within the WO release date pick horizon.
- For production order component item picking data:
 - Allocation Policy = General
 - Pick Policy = Transfer

Replenishment Method - Production Order

- The current Production Order Manual Allocations API does not support updating the PICKED QTY; therefore, the only method we currently have to determine QTY picked is by determining if a component is detail allocated or issued.
- Order status must be for Order Type blank and S.
 - Note** The query does not include S type with an Exploded status.
- Pick quantity must be greater than 0 (zero), and detail allocated must be less than the quantity required.
- The Pick Policy cannot be set to No Pick.

Replenishment Method - Picklist

- Cannot pick a serial ID (Pack) and transfer it; otherwise an error message is received. Blank not allowed.
- Must pick the lot detail allocated; otherwise the original picklist requirement is not reduced—resulting in a double pick.
- The picklist site must be the user log-in site.
- If the Picklist requirement does not reference a Production Order, transaction will not process. Invalid entry for work order.
- The picklist pick quantity must be greater than 0 (zero).

Replenishment Method - Kanban

- N/A

Replenishment Method - Min/Max

- QAD Warehousing must be installed and enabled.
- Does not factor in location capacity.
- Start/end date range must include the current date.
- Site must be the user log-in site.
- Location QOH must be less than the replenishment point.
- Component supply inventory must be available.

- Backflush and reserved locations are excluded.

Linked - Pack Create by Pack Code

Important There are user setup requirements for this transaction to work for a given user.

- Users should use caution if also using Work Order Serial Booking.
- If there is an error where the ser_mstr user field is not updated, there is currently no method to update the field.

Minimum System Setup

QAD Serialization

You must install and enable QAD Serialization to pick by a serialized pack. For information on installing the correct version of QAD Serialization with the Production Orders version you use, refer to the *QAD Production Orders Installation Guide* for your version.

Line Side Replenishment Request (Parent)

- N/A

Replenishment Method - Line Side Direct

- Replenishment locations defined by item
- Replenishment Min/Max defined for item

Replenishment Method - Resource

- Backflush locations defined for work centers
- Item Master/Site Allocation Policy = General
- Item Master/Site Pick Policy = Transfer
- Item BOM associated to routing operation of a work center with a backflush location

Replenishment Method - Production Order

- Item Master/Site Allocation Policy = General
- Item Master/Site Pick Policy \diamond No Pick
- Item BOM associated to routing operation of a work center with a backflush location

Replenishment Method - Picklist

- N/A

Replenishment Method - Kanban

- N/A

Replenishment Method - Min/Max

- QAD Warehousing must be installed and enabled.
- Replenishment locations defined by item
- Replenishment Min/Max defined for item

Minimum Data Required

Line Side Replenishment Request (Parent)

- N/A

Replenishment Method - Line Side Direct

- Available Inventory to pick
- Location QTY < Replenishment Location Min qty

Replenishment Method - Resource

- Released Discrete or Scheduled Orders
- Available Inventory to pick
- Component Demand > Backflush Location QOH Supply

Replenishment Method - Production Order

- Released Discrete or Scheduled Orders
- Available Inventory to pick
- Production Order Component Demand > Detail Allocate

Replenishment Method - Picklist

- N/A

Replenishment Method - Kanban

- N/A

Replenishment Method - Min/Max

- Available Inventory to pick
- Location QTY < Replenishment Location Min qty

Flow Chart

Fig. 5.7
Production Order Pick/Transfer

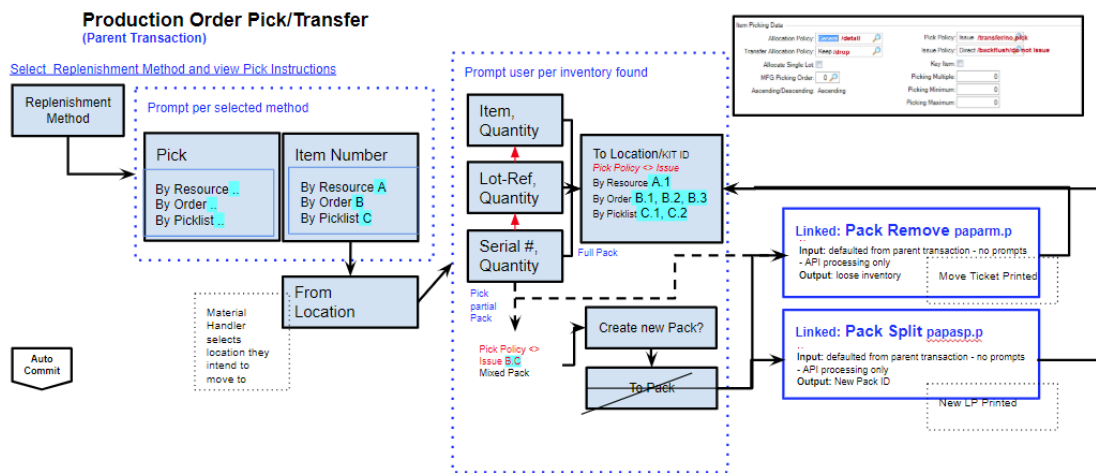

Fig. 5.8
Production Order Pick/Transfer Flows

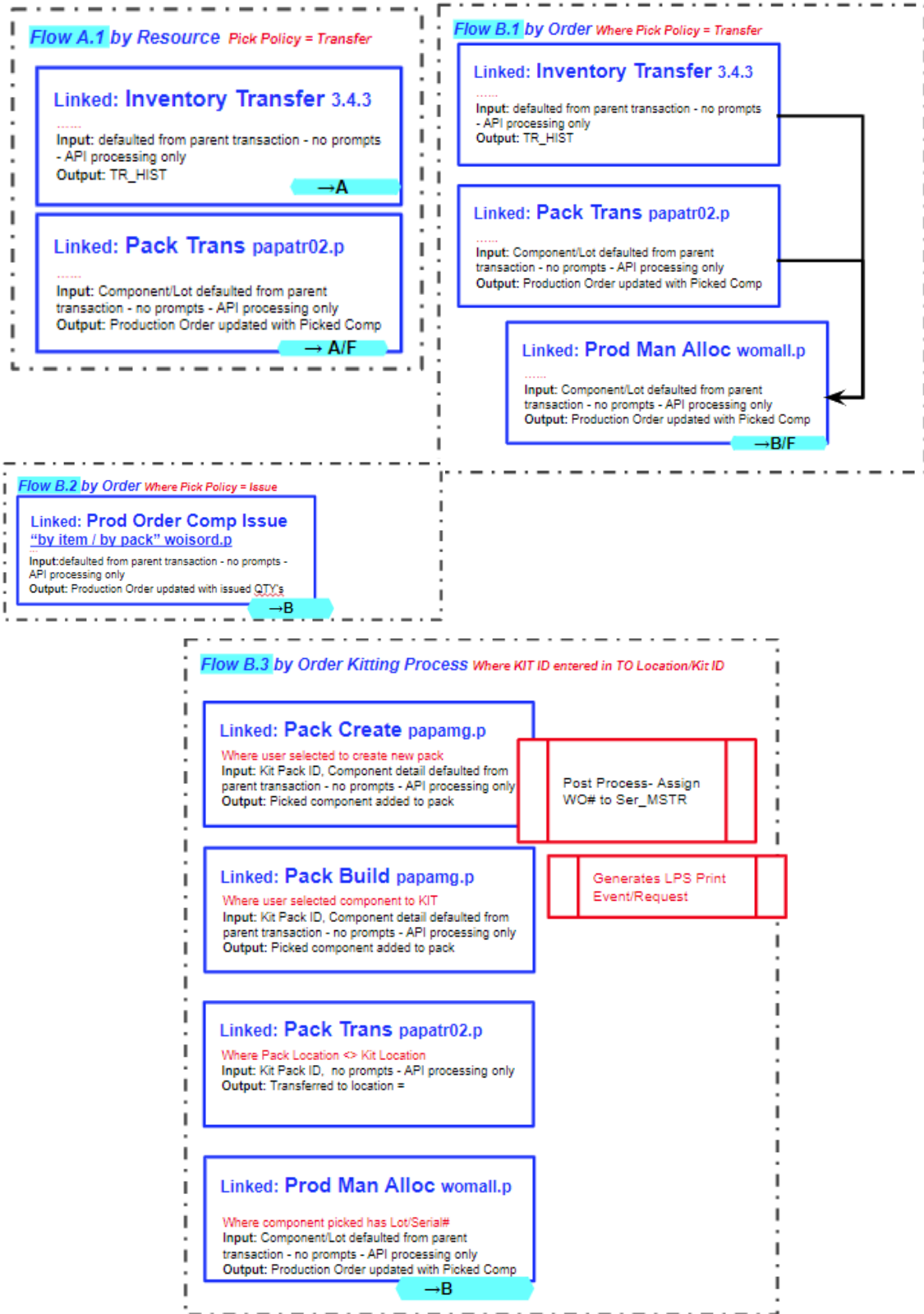

Fig. 5.9
Production Order Pick/Transfer Flows



Field Information

This section contains field-level details for the following parent and linked transactions:

- Parent Transaction - Production Order Pick/Transfer
- Linked - Line Side Replenishment Method
- Linked - Resource Replenishment Method
- Linked - Replenish by Production Order
- Linked - By Production Order Picklist Method
- Linked - Kanban Replenishment Method

- Linked - Pick by Location Min/Max Method
- Linked - Pick Item - Lot - Serial ID
- Linked - Pack Create by Pack Code
- Linked - Pack Build
- Linked - Pack Transfer
- Linked - Production Order Manual Allocation
- Linked - Pack Remove
- Linked - Pack Split
- Linked - Inventory Transfer
- Linked - Pack Transfer with Lot/Serial Change
- Linked - Pack Decommission
- Linked - Production Order Picklist Pick
- Linked - Production Order Pick/Transfer
- Linked - Production Order Picklist Issue
- Linked - Production Order Component Issue
- Troubleshooting

Parent Transaction - Production Order Pick/Transfer

This is the parent transaction that determines the picking method to use. Gathers information required to process linked transactions related to picking/kitting/transfer/issue of inventory.

Note The method could be auto-determined in the future with Warehousing setup.

Manages all linked transactions with the primary purpose of minimizing partial/failed transaction processing by gathering all up-front data and pre-validation, before invoking linked transactions.

Field Name	Comments
tt...Production Order Pick/Transfer	

Field Name	Comments
Site (Hidden)	Defaulted per user log-in
Replenishment Method <i>(Data entry field)</i>	<p>Select Replenishment Method.</p> <p>Validations: Method exists per look-up.</p> <p>Look-up Name: Replenishment Method</p> <p>Auto-display: Yes</p> <p>Default Selected Values: Request Type, Request Method</p> <p>Look-up Query Rules:</p> <p>Look-up Fields:</p> <ul style="list-style-type: none"> • Requests (Sort 1 Ascending): The number of records found in DB/Site for Request Type. • Seq (Request Type) <ul style="list-style-type: none">1 (<i>Line Side Direct</i>). Records per DCworkfile containing Line Side Replenishment Requests transaction.2 (<i>Resource Replenishment</i>). Number of Scheduled orders with status E,A,R with open component requirements and Discrete orders with status A,R.3 (<i>Production Order</i>). Total production orders released for site (same query per Order ID field look-up).4 (<i>Picklist</i>). Total open picklists (sequences) with open pick requirements.5 (<i>Kanban</i>). Open kanbans.6 (<i>Min/Max</i>). Open Min/Max requests. Note: This method can only be used if the Warehousing Extension is installed.

Linked - Line Side Replenishment Method

Parent transaction will gather information required to process linked transactions related to replenishment by Line Side signals. Demand signals are generated by the creation of a replenishment pick request.

The following fields apply specifically when the *Line Side Direct* pick method is selected.

Field Name	Comments
ttLineSide - Line Side Replenishment Method	
^Replenishment Location <i>(Data entry field)</i>	<p>Select signal to replenish.</p> <p>Validation: Valid record</p> <p>Look-up Name: Replenish Signal</p> <p>Displays DC workfile event records created by Line Side Replenishment Request transaction</p> <p>Auto-display: Yes</p> <p>Default Selected Values:</p> <p>Look-up Query Rules: Find all DC workfile events created per user log-in site for Line Side Replenishment Requests.</p> <p>Look-up Fields:</p> <ul style="list-style-type: none"> • Rep Loc: The location requested to replenish. • Rep Item: The item requested to replenish. • Rep Qty: The qty requested to replenish - minus what has already been replenished. • Priority (Sort 1 ascending) • Created (Sort 2 ascending). The date when the replenishment request was created. • Time (Sort 3 ascending). The time when the replenishment request was created. • Requester: The user who created the replenishment request.

Linked - Resource Replenishment Method

Generates material replenishment signals driven by scheduled production order orders for work center backflush locations.

Demand signals are dynamically generated by comparing the scheduled production orders against the QOH component balances at production line and work center locations. For example, if two production orders are released to production and the total required quantity for component A is 300 and the QOH balance at the work center is 45, then the system will generate a signal to replenish QTY 55 for A item.

The following fields apply specifically when the *Resource Replenishment* pick method is selected.

Field Name	Comments
ttResource - Resource Replenishment Method	
Resource (Work Center) (Data entry field)	<p>Select resource (work center) to replenish.</p> <p>Validation: Valid work center</p> <p>Look-up Name: Replenish Resource Locations</p> <p>Display list of resource replenishment locations where component pick demand exists.</p> <p>Auto-display: Yes</p> <p>Default Selected Values: Item Number</p> <p>Look-up Query Rules:</p> <ol style="list-style-type: none"> Where site = user log-in Where work center backflush locations [production line, work center] Where production order demand exists per Order Type = "Discrete" & "S" <ul style="list-style-type: none"> where status = "E,A,R" where Release Date <= transaction configuration field "dDate" Where Production Order component Item Picking Data <ul style="list-style-type: none"> Allocation Policy = General Pick Policy = Transfer Where component defined operation/work center, then demand applies to the work center backflush location <ul style="list-style-type: none"> In cases where production order operation on component is "blank", assume first operation/work center. Where production order component required qty > 0 Where component supply inventory is available <ul style="list-style-type: none"> Where location status = "available" If generalized codes defined further refine locations to pick from: Where location ld_det.ld_status = generalized code: Group: "DC" Field Name: "Production_Order_Pick_Loc_Status", Value "location status" Excludes backflush locations [production line + work center] Excludes reserved locations not associated to backflush location [production line + work center] <p>Look-up Fields:</p> <ul style="list-style-type: none"> Resource Name: Resource name associated to backflush location. Backflush Location (->>>, >>>9): Display workcenter backflush locations driving demand. Resource Type: Resource associated to backflush location. Priority (Sort 1 ascending): Display/find oldest open production order release date and order sequence for backflush location driving replenishment demand.

Field Name	Comments
WO release Date - Pick Horizon	<p>Purpose: Defines horizon of orders to pick by release dates.</p> <p>Default = Tomorrow (does not currently factor in shop calendar). The default value can be changed in Transaction Definition Maintenance.</p>
Item <i>(Data entry field)</i>	<p>Select from look-up item to pick for.</p> <p>Validation: Valid Item per site</p> <p>Look-up Name: Resource Replenishment</p> <p>Display list of components to be picked per selected work center.</p> <p>Auto-display: Yes</p> <p>Default Selected Values: Item,To Location</p> <p>Look-up Query Rules: Same Query as defined on the Resource Look-up</p> <p>Look-up Fields:</p> <ul style="list-style-type: none"> • P (Picker): Displays user ID per user whom has selected this item to pick Field values: F = False T = True. • Item Number (11Char) • Pick Loc • Pick Req (->>>, >>>9): [Req Qty - WC Backflush LOCATION QOH] Req Qty: [Total all production orders with "R" status] • Loc Desc (8Char): Displays the description of the WC Loc. • WC Loc: The location of the Work Center per the Work Order BOM operation. • WC QOH (->>>, >>>9): QTY OH per Location = to WO Routing Work Center per component. • Release (Sort 1 ascending): Displays oldest Work Order Release date per component requirement. • Seq (Sort 2 ascending) (8Char): Displays sequence ID of the oldest Work Order Release Date. • WO ID Ref: Displays the WO ID of the oldest work order release date/sequence found. • Item Description • Picker Name <p>P (Picker) Field Details:</p> <p>Displays user ID per user who has selected this item to pick Field values: F = False T = True.</p> <p>ADC workfile is created per the user UI, Item Number when user selects the item number to pick. The purpose of the field is to indicate to other users that someone is working on this pick to prevent multiple people from working on the same pick. If both users select the item at the same time to pick, then it is still possible both users will work on the same pick. This should be a rare exception with no negative business impacts.</p> <p>Questions: What if a user does not complete the transaction or aborts? How does the field get cleared?</p> <ol style="list-style-type: none"> 1. Add a time-stamp on the record (item) selected by the user. 2. Per the DC transaction dummy field to define the picktimeout; for example, 5mins dPickTimeout in buffer dtfTransLotSerial 3. When user opens the Item Look-up, remove all DC workfile records where current time compared to time-stamp is > than picktimeout <p>Note: If the Item look-up is opened by a second user while the first user remains in the look-up.</p> <p>The lookup is based on domain and userid to create dcworkfile records. But once user closes the lookups, the records are deleted. If this is an issue we will need to change the keyfields.</p>

Linked - Replenish by Production Order

Demand signals are dynamically generated by comparing the Production Order BOM QTY required against the QTY Picked/Allocated/Issued to determine if additional components require picking. For example, if production orders are released to production and the total required quantity for component A is 100, the QTY picked is 30, and the quantity detail allocated is 20, then the required QTY to pick is 50.

The following fields apply specifically when the *Production Order* pick method is selected.

Field Name	Comments
ttProduction_Order - Replenish by Production Order	
Order ID <i>(Data entry field)</i>	Select order ID to pick for. Validation: <ul style="list-style-type: none"> Valid Order ID Order Status = A,R Picklist does not exist for order Look-up Name: Production Order Auto-display: Yes Default Selected Values: Order ID Look-up Query Rules: <ul style="list-style-type: none"> Where order status = "A,R" for order type = "blank" & "S" Where no Picklists exist for production order Where 1 or more components with pick required quantity > 0 (detail allocated < QTY required) Where Pick Policy <> No Pick Lookup Fields: <ul style="list-style-type: none"> ID (Sort 3 ascending) Item Number: This is the parent item per the production order Qty Open: Production order Quantity Open Release (Sort 1 ascending): Order release date Shift/Sequence (Sort 2 ascending): Concatenated production order Shift "wo_mstr.wo_shift" & Sequence "woSeq" Order Type: Schedule or discrete order

Field Name	Comments
Item Number <i>(Data entry field)</i>	<p>Select item to pick.</p> <p>Validation: Item needs to exist on selected production order bill of material</p> <p>Look-up Name: Components</p> <p>Auto-display: Yes</p> <p>Default Selected Values: Component, BOM Operation</p> <p>Look-up Query Rules:</p> <p>For each production order BOM record:</p> <ul style="list-style-type: none"> • Where Pick Policy <> No Pick • Where component Pick Required > 0 • Where component detail allocated < QTY required Note: When component material is detail allocated per order release, can use Transfer by Order transaction, which support ability to transfer detail allocated inventory From/To locations. • Detail status = “ “ <p>Look-up Fields:</p> <ul style="list-style-type: none"> • DA: Displays “Y/N” if detail allocations exist for selected component • Pick Loc (Sort 1 Ascending) • Component: BOM Component • Ord Det Alloc: Detail allocation qty for component / order • Required (Sort 2 Ascending) • Picked: QTY picked against the order • Issued: QTY issued against the order • BOM Reqd: Display the required QTY per the WO BOM for the original start QTY • OP: Operation defined on production order BOM • Pick Policy: From Work Order BOM Detail • UOM • Description <p>Pick Loc Field Details:</p> <p>Displays suggested location to pick inventory from.)</p> <ul style="list-style-type: none"> • If no detail allocation exists • Check reserved locations (see existing procedures) • Then check <code>icc_ctrl.icc_pk_ord</code> Picking Logic, making all methods available in the following sequence) <ul style="list-style-type: none">(Picking Logic 4) Find oldest lot expire date where Lot Expire date >= Order Due Date + x days “5 is the default”(Picking Logic 2) Find oldest lot/location create date(Picking Logic 5 “AS Only”) Find oldest serial unit serial_mstr, ser_mod_date Pack date (applicable non lot controlled inventory)(Picking Logic 3) Find oldest location creation date • Exclude where: <ul style="list-style-type: none">Location = production line, work center backflush locationLocation status <> availableLd_det <> availableLocation = current detail allocation for orderLocations where qty is packed in a multi-item pack and there is no loose inventory or single item/pack <p>Picked Reqd:</p> <ul style="list-style-type: none"> • Pick Policy = Transfer [BOM Reqd - (Detail Allocated + Issued)] • Pick Policy = Issue [BOM Reqd - (Issued)]

Field Name	Comments
	<p>A note about Picking Order</p> <p>Enter the value that indicates the picking sequence to use when detail allocating to production orders and sales orders.</p> <p>Detail allocations are created when production orders are released and picklists printed and when sales order packing lists are printed. Picking order determines which inventory is allocated first.</p> <ul style="list-style-type: none"> • 1 (<i>default</i>). Inventory is allocated and picked by location. This method is useful when you have sequential warehouse locations laid out for easy picking. • 2. Inventory is allocated and picked by lot/serial number. This method is useful when you assign meaningful lot/serial numbers; for example, this allows you to pick the oldest lots first. • 3. Inventory is allocated and picked by date created. This method is useful in LIFO and FIFO picking, but only if all inventory receipts are segregated by location, lot/serial, or lot reference number. Otherwise, the date created is meaningless. • 4. Inventory is allocated and picked by expiration date. If you have items with a limited shelf life, this is useful for making sure those closest to expiration are picked first.

Linked - By Production Order Picklist Method

Parent transaction gathers information required to process linked transactions related to Production Order picking/transfer/issue. The parent transaction links to the following transactions:

- Production Picklist Pick
- Production Order Picklist Transfer
- Production Order Picklist Issue

Background: Picklist method uses picklists as the directive input for picking. The system determines the correct (Pick/Transfer/Issue) picklist programs to use based on the picking policy for the item/production order.

If using bulk picklists, the transaction does not consolidate the requirements into a single pick. The user will see two individual pick requirements because there could be different detail allocations for each Bulk Pick. This does not prevent the user from picking for both lines if the detail allocations are the same item/lot/location.

The following fields apply specifically when the *Picklist* pick method is selected.

Field Name	Comments
ttPicklist - By Production Order Picklist Method	
Picklist <i>(Data entry field)</i>	<p>Enter Picklist to Pick.</p> <p>Validation: Picklist ID valid per user log-in site</p> <p>Look-up Name: Picklist</p> <p>Auto-display: Yes</p> <p>Default Selected Values: Picklist Number and Sequence</p> <p>Look-up Query Rules:</p> <ul style="list-style-type: none"> • Find/display picklists where log-in site = picklist site • Where picklist pick qty > 0 <p>Look-up Fields:</p> <ul style="list-style-type: none"> • (P) Picker: Displays user ID per user who has selected this item to pick. Note: The pick timeout is set to 300ms. If the pick takes more time, the DC workfile is removed. • Picklist (Sort 1 Ascending): Open picklist for log-in site. • Resource: As defined on the picklist. Currently represents production line. • Location: Displays first location found in picklist where picklist materials are to be transferred to. • Open Picks: Displays number of items to pick for picklist. • Sequence (Sort 2 Ascending): Picklist sequence number. • Type. • Order ID: First order ID displayed for picklists. • Created: Date picklist created.
Pick Sequence <i>(Data entry field)</i>	<p>Defaulted per prior field look-up.</p> <p>Prompt if user did not select from prior look-up and multiple open sequences exist.</p>
Pick Allocated	Default = No
Pick by Pack	Conditional: If user picks a serial ID, "Yes", otherwise "No"
Effective Date	Default = Today (Hidden Field)

Field Name	Comments
Use To Location Status	Default = Yes (Hidden Field)
Item Number (Data entry field)	<p>Enter/Scan Item to transfer.</p> <p>Validation:</p> <ul style="list-style-type: none"> • Open Item to pick per selected picklist. • Call all API validations. <p>Look-up Name: Picklist Items</p> <p>Auto-display: Yes</p> <p>Default Selected Values: Item Number</p> <p>Look-up Query Rules:</p> <ul style="list-style-type: none"> • Displays all items on picklist to be picked where pick required > 0. • Displays only items where inventory is available. <p>Lookup Fields:</p> <ul style="list-style-type: none"> • DA: Displays “Y/N” if OPEN Alloc detail allocations exist for selected component. • Pick Loc: Derived from picklist. If not defined, the location per Inventory Control policy. • Pick Reqd: Derived from picklist (summarizing where Picklist number, Sequence, Part and Destination Location are same). • Pick Policy: Derived from picklist. • Issue Policy: Derived from picklist. • UOM: Derived from picklist. • Picked: Derived from picklist. Only updates when user performs a pick and not a transfer. This transaction is configured to always transfer, so the picked QTY will never display anything but “0”. • Issued: Derived from production order.

Linked - Kanban Replenishment Method

This is the parent transaction that determines the picking method to use. Gathers information required to process linked transactions related to picking/kitting/transfer/issue of inventory.

Note The method could be auto-determined in the future with Warehousing setup.

Manages all linked transactions with the primary purpose of minimizing partial/failed transaction processing by gathering all up-front data and pre-validation, before invoking linked transactions.

The following fields apply specifically when the *Kanban* pick method is selected.

Field Name	Comments
tt... Replenishment Method - Kanban	
Kanban ID <i>(Data entry field)</i>	Input or scan Kanban Card ID Default Value: Blank Validations: <ul style="list-style-type: none"> • Blank not allowed • Valid Kanban Card • Active Kanban Card • Status = Authorized (if status is Empty Accumulate or Full then show error message displaying existing status) Look-up (all active Kanban Cards): <ul style="list-style-type: none"> • Kanban Card ID • Kanban Part • Kanban Qty
Kanban Part	Kanban Part- Display only Field Default Value: Kanban Part default from selected Kanban ID
Desc	Item Description - Display only Field Default Value: Description of Kanban Part
Step	Step- Display only Field Default Value: Step from selected Kanban ID
Card Status	Card Status- Display only Field Default Value: Card Status from selected Kanban ID
Kanban Qty	Kanban Qty- Display only Field Default Value: Kanban Qty from selected Kanban ID
Card type	Card Type- Display only Field Default Value: Card Type from selected Kanban ID
SuperMarket	Super Market ID- Display only Field Default Value: Super Market ID from selected Kanban ID

Field Name	Comments
Event	Event = FILL Yes for Consume - Background Field (No display, no update) Default Value: Yes
Confirm	Input Yes/No Default Value: Yes Display Fields: Kanban ID, Kanban Part, Item Desc, Step, Card Status, Kanban Qty, Card Type, Super Market ID Commit: If Yes then do the commit for Kanban Fill process. Execute custom API to do the Fill process. The card status will change from Authorized to Full in QAD. Loop back to Kanban Card field. Business Process: When a Kanban card is dropped/consumed for a purchased item, it should be eligible to authorize replenishment. A card needs to release an order when it is the last of the demand trigger. If the quantity of the card is equal to the quantity of the trigger, each drop will release an order. However, if the quantity of the card is a fraction of the trigger quantity, only the appropriate multiple will release an order. For example, if item ABC has Kanban cards representing 10 units and the agreement with ABC's supplier dictates orders in multiples of 50, the first four card drops sit in a virtual queue until the fifth card reaches the order quantity and authorizes replenishment. Order release should be automatic upon scan of the final card. Once consumption of Kanban card(s) quantity meets order quantity setup, QAD will change the status of all the empty Kanban cards to Authorized automatically. This means these Kanban cards are ready to fill. .NET UI user will execute Kanban Dispatch List Processing. This automatically releases the blanket Purchase Orders for the authorized Kanban cards.

Linked - Pick by Location Min/Max Method

Note The Min/Max replenishment method can only be used if the Warehousing Extension is installed.

Generates material replenishment signals based on Replenishment Location Min/Max settings.

Background: Replenishment Location Maintenance (Warehousing module) provides the ability to define a Min/Max for an item. It is beneficial to leverage this setup and then check QOH for each defined location dynamically.

The following fields apply specifically when the *Min/Max* pick method is selected.

Field Name	Comments
tt... Replenishment Method - Min/Max	
Item Number <i>(Data entry field)</i>	Select item to replenish. Validation: Valid item Look-up Name: Replenishment Locations Display list of items to replenish for each location Auto-display: Yes Default Selected Values: Item Number Look-up Query Rules: Find Replenishment Location records where: <ol style="list-style-type: none"> 1. Where current date is within start/end date range of replenishment record 2. Where site = user log-in 3. Where location QOH < Replenishment Point 4. Where component supply inventory is available <ul style="list-style-type: none"> • Where location status = "available" • If generalized codes defined further refine locations to pick from: Where location Id_det.Id_status = generalized code: Group: "DC" Field Name: "Production_Order_Pick_Loc_Status" , "location status" • Excludes backflush locations [production line + work center] • Excludes reserved locations

Linked - Pick Item - Lot - Serial ID

The transaction directs the user to recommended locations to pick from. The user selects from the look-up the location they will pick from and physically goes to that location. Arriving at the location, the user picks the material. User then goes to the destination location and once there, the user scans the destination location bar code to confirm delivery of the material.

All picking methods should be generally consistent in directing users to preferred locations (FIFO) or specific locations in the case where material is detail allocated to an order. All picking methods support the ability to pick a Pack, Lot, or Item.

Note Fields prompts below are applicable to all picking methods. In cases where the picking method has specific rules/validations, these differences are noted below.

Field Name	Comments
Pick Item - Lot - Serial ID	
ttResource	
ttOrder	
ttPicklist	
ttMin/Max	
ttLineSide	
Picklist	Redisplay if Pick Method = Picklist.
Order ID	Redisplay if Pick Method = Order.
Resource	Redisplay if Pick Method = Resource or Line Side.
Item	Redisplay selected item.
Description	Description of selected item.

Field Name	Comments
Required	<p>Display the required Pick QTY per the item selected in the look-up (see Pick QTY look-up rules per calculation).</p> <p>Note: The pick required value comes from different sources based on the Pick Method.</p> <ul style="list-style-type: none"> • By Resource -> see Pick QTY per the calculation used in the Item Resource Look-up • By Order -> Calculates per remaining on Order BOM • By Picklist -> From picklist • By Line Side -> Line Side record value • Min/Max -> calculated value
^Location From <i>(Data entry field)</i>	<p>Applicable to picking by Production Orders and Picklists</p> <p>Scan/Enter location from.</p> <p>Validations: Location is valid and not restricted.</p> <p>Validations specific to Pick by Order and Pick by Picklist Replenishment Methods: If detail allocation exists for item, then location selected must = location of detail allocation.</p> <p>Look-up Name: Pick From Location (Best Pick Location)</p> <p>Auto-display: Yes</p> <p>Default Selected Values: Location</p> <p>Look-up Query Rules: The reserved location features we introduced for Production Orders is modeled after the Customer Reserved Locations. In order to make the reserved locations available only to the Production Line and Work Center it is linked to, we have to set up the Inventory Status Code to Not Available. The logic for detailed allocations is written to look at these locations regardless of the inventory status when inventory is allocated for production at a linked Production Line or Work Center. By setting the status to Not Available for these locations, the allocation logic will ignore these locations when allocating for production at all other production lines and work centers and when allocating SO and DO as well.</p> <p>Look-up Query Rules:</p> <ol style="list-style-type: none"> 1. Where non-zero inventory balance for selected item. 2. Display a location only one time; if multiple <i>ld_dets</i> exist, only display first instance. 3. Where location STATUS code = generalized codes values for: <ul style="list-style-type: none"> • GROUP: "DC" • FIELD NAME: "Production_Order_Pick_Loc_Status" , "value" • If generalized code not found, display where location status = available • Where VALUE = location status 4. Where location TYPE code = generalized codes values for: <ul style="list-style-type: none"> • GROUP: "DC" • FIELD NAME: "Production_Order_Pick_Loc_Type" , "value" • If generalized code not found, display where location status = all types • Where VALUE = location type 5. Related to Pick by Production Order Kitting Rules. Does not display locations of Production Order KITS, because materials are already picked for other orders. 6. Excludes locations defined as Production Line 16.1.1, <i>splnmt.p ln_mstr.ln_backflush_loc</i> and Work center 14.5, <i>rwwcmt.p, wc_mstr.wc_backflush_loc</i> backflush locations.

Field Name	Comments
(Continued) ^Location From (Data entry field)	<p>Look-up Fields:</p> <p>Note: The sorting sequence may not match the Inventory Control setting.</p> <ul style="list-style-type: none"> • DA (Sort 1 descending): Displays “Y/N” if OPEN detail allocations exist for selected component per the Production Order / Picklist. Not applicable to other picking methods such as Resources, Kanban, and so on. • Location: Inventory location with available inventory to pick. • QOH (->>>, >>>9.<<): Quantity on Hand. • Ord Det Alloc: Production Order detail allocations for component. Not applicable to other picking methods such as Resources, Kanban, and so on. • Expire (Sort 2 ascending): displays oldest Id_det record expire date. • Serial Date (Sort 3 ascending): Oldest serial_mstr record found in location per modified date “ser_mod_date” field. • Created (Sort 4 ascending) • Location Status(Loc St): Location Status • Location Description
^Location From (Data entry field)	<p>Applicable to picking by Min/Max, Resource Replenishment, Line Side Replenishment</p> <p>Scan/Enter location from.</p> <p>Validations: Location is valid and not restricted</p> <p>Look-up Name: Pick From Location (Best Pick Location)</p> <p>Auto-display: Yes</p> <p>Default Selected Values: Location</p> <p>Look-up Query Rules:</p> <ol style="list-style-type: none"> 1. Where non-zero inventory balance for selected item. 2. Display a location only one time; if multiple Id_dets exist, only display first instance. 3. Where location STATUS code = generalized codes values for: <ul style="list-style-type: none"> • GROUP: “DC” • FIELD NAME: “Production_Order_Pick_Loc_Status”, “value” • If generalized code not found, display where location status = available. • Where VALUE = location status 4. Where location TYPE code = generalized codes values for: <ul style="list-style-type: none"> • GROUP: “DC” • FIELD NAME: “Production_Order_Pick_Loc_Type” , “value” • If generalized code not found, display where location status = all types • Where VALUE = location type 5. Excludes locations defined as Production Line 16.1.1, <i>splmnt.p ln_mstr:ln_backflush_loc</i> and Work center 14.5, <i>rwwcnt.p, wc_mstr:wc_backflush_loc backflush</i> locations. <p>Look-up Fields: Same as Location From field above.</p>
<p>The following fields are prompted based on the inventory available in the selected pick from location.</p> <ul style="list-style-type: none"> • Consideration 1: Prompt for Item/pack serial ID if serialized inventory exists. • Consideration 2: Prompt for Lot/Serial if loose inventory exists. • Consideration 3: Prompt for Item Number & Quantity if loose inventory exists. <p>Handles the most complex use case where for a single item, all scenarios exist in a single location.</p> <p>Transaction Design Limitations: Only supports picking a UNIT PACK with single item/lot/serial.</p>	

Field Name	Comments
Serial ID <i>(Data entry field)</i>	<p>Only applicable if inventory in the From Location has serial IDs. Otherwise user is not prompted.</p> <p>Scan/Enter Item / Pack Serial ID to pick per prior selected item/location to pick.</p> <p>Validations:</p> <ul style="list-style-type: none"> • Record exists. • Inventory is not detail allocated to another order/picklist. • Scanned Serial Pack is a single item/lot with no serialized Units. <p>Rules/Validations specific to Replenishment Methods</p> <p>Pick by Order/Picklist</p> <ul style="list-style-type: none"> • Check if detail allocation exists for the component selected for picking. If Detail Allocation exists, only permit user to select the detail allocated inventory. • Because the current API does not support selecting any specific quantities, lot/unit serial IDs in Pack, we need this validation: If user enter QTY less than in pack AND serialized Units/Lots exist, present error message, “Must first remove Serial/Lots from Pack before picking?” <p>Pick By Resource</p> <ul style="list-style-type: none"> • If user enters QTY less than in pack AND serialized Units/Lots exist, present error message, “Must first remove Serial/Lots from Pack before picking?” <p>Look-up Name: Serial ID</p> <p>Auto-display: No</p> <p>Default Selected Values: Serial</p> <p>Look-up Query Rules:</p> <ol style="list-style-type: none"> 1. All serial IDs in selected location where status = “Active”. 2. To encourage user to pick serial IDs with detail allocations and avoid picking detail allocations of other orders: <ul style="list-style-type: none"> • If selected item has detail allocation, only display detail allocations for selected picklist/order. • If selected item does not have detail allocations, then show all records. <p>Look-up Fields:</p> <ul style="list-style-type: none"> • DA (Sort 1 descending): Displays “Y/N” if OPEN detail allocations exist for selected component per the Order/Picklist. • Ord Det Alloc: Detail allocations for component/order. • Serial: Inventory serial ID record. • Pack QTY: Quantity in Pack (serial ID) • Stage: Stage of Serial ID (Active,Picked) • Type: Is the serial ID a package or item serial ID? • Allocation ID: Displays the Picklist ID or Order ID the material is detail allocated to. • QOH: Quantity on Hand • Expire: Oldest expire date of lot in pack. • Serial Date (Sort 2 ascending): Serial Detail - record create dateOrder Detail Allocated: QTY detail allocated to an order in pack • Location Status(Loc St): Location Status. • Location: Inventory location with available inventory to pick.

Field Name	Comments
Lot <i>(Data entry field)</i>	<p>Scan/Enter Lot/Serial to pick per prior selected item/location to pick.</p> <p>Only applicable if inventory in the From Location has lots. Otherwise user is not prompted.</p> <p>Validations:</p> <ul style="list-style-type: none"> • Record exists. • Inventory is not detail allocated to another order/picklist. <p>Rules/Validations specific to Pick by Order/Picklist Replenishment Method:</p> <ul style="list-style-type: none"> • Check if detail allocation exists for the component selected for picking. If Detail Allocation exists, only permit user to select the detail allocated inventory. • Check if LOT attributes conform to item profile: Item Site, Item Site Production Line, Item Production Order. <p>Look-up Name: Lot/Ref ID</p> <p>Auto-display: No</p> <p>Default Selected Values: Serial</p> <p>Look-up Query Rules:</p> <ol style="list-style-type: none"> 1. Where Location QOH >0 2. To encourage user to pick serial IDs with detail allocations and avoid picking detail allocations of other orders: <ul style="list-style-type: none"> • If selected item has detail allocation, only display detail allocations for selected picklist/order. • If selected item does not have detail allocations, then show all records. <p>Look-up Field Details:</p> <ul style="list-style-type: none"> • DA (Sort 1 ascending): Displays “Y/N” if OPEN Alloc detail allocations exists for serial record for THIS ORDER/PICKLIST • Order Detail Allocated: QTY detail allocated to an order in pack. • Lot/Serial(Sort 2 ascending) (x10): Displays lot ID. • Serial: Inventory serial ID record • Pack QTY (x10): Quantity in Pack (serial ID) • Allocated Order: Displays the Picklist ID or Order ID the material is detail allocated to. • Created: The data the serial ID was created. • Location Status(Loc St) • Location • Stage: Stage of Serial ID (Active,Picked) • Type: Is the serial ID a package or item serial ID?
Reference <i>(Data entry field)</i>	Same rules/look-up as prior field.
Item to Pick <i>(Data entry field)</i>	<p>Scan/Enter Item to pick per prior selected item to pick.</p> <p>Validations:</p> <ul style="list-style-type: none"> • Item is valid per site. • Pick by Order/Picklist: Item is on picklist/order.

Field Name	Comments
Quantity to Pick <i>(Data entry field)</i>	Input quantity to pick. Default: Default quantity; where qty = lessor of required pick QTY or QTY available to pick per location's item,lot,unit pack. Validations: <ul style="list-style-type: none"> • QTY > 0 • Validate inventory is available. Otherwise, error message appears: "Not enough inventory for <item number> in location <location>". Validations specific to Pick By Picklist or Pick By Order: <ul style="list-style-type: none"> • Quantity "detail" allocated may not be greater than quantity required. The reason is that you cannot detail allocate more than the order requires. • Pick quantity is greater than quantity on hand. The reason is the QTY trying to pick is inside a Pack containing multi-item and Lot. So while the location shows a QTY available, the QTY is inside a pack containing multiple items/lots, which we do not support picking from.
Deliver To:	Display the location to deliver the materials. Rules based on Replenishment Method: By Order, defaults work center/production line backflush locations.

Field Name	Comments
Location To/KIT ID <i>(Data entry field)</i>	<p>Prompt/Scan Location To. Do not prompt/Display if Pick Policy = Issue.</p> <p>Default value rules based on Replenishment Method:</p> <ul style="list-style-type: none"> • By Resource, then default selected replenishment location • By Picklist, then default destination location per Picklist. When the pick policy = issue, then do not prompt for TO Location. Display only the destination location per picklist. Default Operation should be per BOM operation defined on routing. <p>Default value for Kitting: After a KIT ID is created through the first item pick, the KIT ID will default when user attempts to pick second item while remaining in the transaction. This is primarily useful for demonstration, but for implementation we anticipate you would want the user to scan the KIT ID physical label as opposed to defaulting it.</p> <p>General Validations:</p> <ul style="list-style-type: none"> • Location is valid and not restricted to move to. • Location is not blank. • DC validation to say, "Error, Unable to receive pack to location with negative QOH" <p>Validations for Pick Method = By Resource (Min/Max, Line Side, By Resource)</p> <p>If Pick Method = Pick by Resource or Line Side, Location TO <> Location From</p> <p>Validations for Pick Method = By Picklist</p> <p>API does support ability to change the TO Location. Validation if user changes destination location not equal to Picklist destination location.</p> <p>Validations for KIT ID (Kitting):</p> <ul style="list-style-type: none"> • KIT ID associated to Order ID. • Location Type must equal the Type of the From location of picked item. • KITID stage = new/active. • KITID Serial UM = source Serial UM. Applicable only when adding an EXISTING unit pack to a master pack. • If user enters the value "KIT", this will trigger the prompt, Create KIT ID? <ul style="list-style-type: none">If the KIT setup has not been completed, display error, "KIT setup not found".If users responds "Y", then perform the KIT Pack Create. <p>Look-up Name: Move To Location</p> <p>Auto-display: No</p> <p>Default Selected Values: Serial</p> <p>Look-up Query Rules:</p> <ul style="list-style-type: none"> • Display per Picklist Transfer To Location • For picking by production orders or by Resource <ul style="list-style-type: none"> = production order routing work center location = production order routing production line location <p>Look-up Fields:</p> <ul style="list-style-type: none"> • Location: Location user should move to. • Resource • Description • Seq (Sort 1 ascending): The locations the user should move the material to in sequence of priority <ul style="list-style-type: none"> 1 - Work Center Backflush location 2 - Production Line Backflush location 3 - Work Center Reserved Locations 4 - Production Line Reserved Locations

Field Name	Comments
All Picking Methods	
tt... Fields prompts below are applicable to all picking methods. Rules/validations specific to each picking method will be noted.	
Printer	Default to "Testprinter" Linked Transactions which call label printing are: <ul style="list-style-type: none"> • Pack Create by Pack Code • Pack Split • Operational Activity where Pack Create/Receipt is performed Validation Rules: Must be valid printer
Decommission Pack?	Conditional prompt for picking method = By Resource Min/Max, Line Side. If decommission set to Yes, after the pack transfer the system will call the pack decommission linked transaction.

Linked - Pack Create by Pack Code

Create a WOKIT to be used in a downstream process to pick serialized boxes of components and associate them to the WOKIT pallet through a pack build.

Custom logic "stamps" the WO ID to Ser_MSTR.ser_user1 to enable downstream tracking and supports the ability to transfer a pack with multiple boxes and update the WO BOM detail with the locations of the allocations.

Customer logic runs a post process to add a "dummy" item to set the location of the WOKIT.

The following values are passed into the linked transaction.

Field Name	Comments
tt... Pack Create by Pack Code	
Item Number	Default value = to selected picked item in prior buffer fields
Site	Default value = log-in site
Pack Code	Set default value = KIT
Nbr Packs	Default to 1
Pack Qty	API defaultsDefault = 9999
Printer	Default = parent transaction
Procedure	Writes the Production Order ID to the Ser_Mstr.Ser_user1. Note: Custom logic "stamps" writes the WO ID to the Ser_MSTR to enable downstream tracking and supports the ability to transfer a pack with multiple boxes and update the WO BOM detail with the locations of the allocations.

Linked - Pack Build

Adds picked items to KIT (Pack).

The following values are passed into the linked transaction.

Field Name	Comments
tt... Pack Build	
Parent Data Frame	
Serial ID	Default from parent transaction, Location To/KIT ID field, or Pack Create in the event a new KIT ID is created.
Child Data Frame	
Serial ID	Blank
Item Number	Default from parent transaction
Site	Default from parent transaction
Location	Default from parent transaction
Lot/Serial	Default from parent transaction
Reference	Default from parent transaction
Quantity	Default from parent transaction

Linked - Pack Transfer

When the user creates the kit, it is not assigned to a specific location. When the user starts picking components to put into the KIT (PACK BUILD) the location of the KIT ID will be set to the location of the picked item and remain in that location until the user transfers the KIT, which could be hours later. This can result in confusion because the picked items will no longer be in the original location, but the ERP system will still show that they are. To address this, when the first item is picked and put into the KIT, the system will auto-transfer the KIT to the location of user log-in ID or to a general location “KIT.”

The following values are passed into the linked transaction.

Field Name	Comments
tt... Pack Transfer	
Serial ID	Default from parent transaction, Location To/KIT ID field or Pack Create in the event a new KIT ID is created
Transfer To Site	Default from parent transaction (= user log-in site)
Location	Default from parent transaction (Location = KIT)

Linked - Production Order Manual Allocation

After the KIT it transferred, we update the Detail Allocations of all components in the KIT, related to the production order of the KIT.

Field Name	Comments
tt... Production Order Manual Allocation	
ID	Default value = selected order in parent buffer
Component	Default value = selected picked item in parent buffer
Operation	Defaults per the BOM Routing field If Item BOM operation value does not match the Item Routing, the API will accept it. For example, if the BOM operation = 0 but the Item Routing does not have an operation = 0.
Location	Default value = Location TO (the location user transferred material to which is defined in parent buffer)
Lot/Serial	Default value = to selected picked Lot/Serial in parent buffer

Field Name	Comments
Reference	Default value = to selected picked Lot/Serial in parent buffer
Quantity Allocated	<p>Default value = to selected picked Lot/Serial in parent buffer</p> <p>Note: If the QTY picked is greater than the QTY Required, the API does not permit allocating more than QTY required. The AS configuration therefore will allocate the lesser of QTY Picked or QTY Required. This allows a user to pick and transfer quantities greater than qty required.</p> <p>Note: When we update the detail allocated after an inventory transfer of the component/KIT, we first do a negative QTY for the component/lot From location and then perform a positive transaction for the new destination location. We do not use the Deallocate field because this will deallocate all records for a selected component, which is not the desired result.</p>
Quantity Picked	The API does not currently support updating the Quantity Picked directly.

Linked - Pack Remove

Field Name	Comments
tt... Pack Remove	
Item Number	Default value = to selected picked item in prior buffer fields

Linked - Pack Split

Field Name	Comments
tt... Pack Split	
Item Number	Default value = to selected picked item in prior buffer fields

Linked - Inventory Transfer

Field Name	Comments
tt... Inventory Transfer	
Item Number	Default value = to selected picked item in prior buffer fields

Linked - Pack Transfer with Lot/Serial Change

Field Name	Comments
tt... Pack Transfer with Lot/Serial Change	
Item Number	Default value = to selected picked item in prior buffer fields

Linked - Pack Decommission

Note The system does not support backflushing components from a pack; therefore, all transactions are configured to automatically decommission a transferred pack to a production line and work center backflush location.

Field Name	Comments
tt... Pack Transfer with Lot/Serial Change	
Item Number	Default value = to selected picked item in prior buffer fields

Linked - Production Order Picklist Pick

Field Name	Comments
tt... Production Order Picklist Pick	
Item Number	Default value = selected picked item in prior buffer fields

Linked - Production Order Pick/Transfer

Field Name	Comments
tt... Production Order Pick Transfer	
Item Number	Default value = selected picked item in prior buffer fields
Backflush Location	Default value = To Location selected in prior buffer fields
Total Transaction QTY	Default value = Picked QTY entered in prior buffer fields
Remove Untransfer Picklist QTY	Default = No (Hidden Field)

Linked - Production Order Picklist Issue

Field Name	Comments
tt... Production Order Picklist Issue	
Item Number	Default value = selected picked item in prior buffer fields

Linked - Production Order Component Issue

Field Name	Comments
tt... Production Order Component Issue	
Operation	Default value = selected picked item in prior buffer fields
Default Qty to Issue	Default = "none"

Troubleshooting

Pick by Resource Replenishment Method

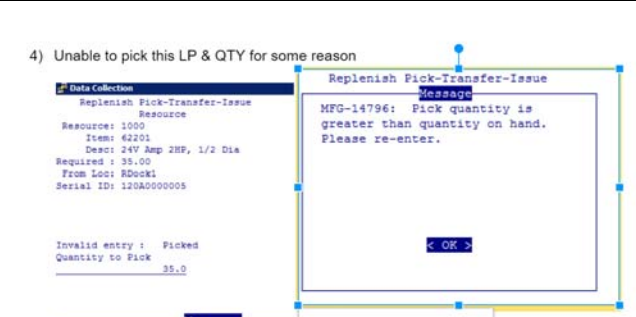
Issue/Error	Root/Solution
<p>4) Unable to pick this LP & QTY for some reason</p> 	<p>Explanation:</p> <ul style="list-style-type: none"> • QTY user is picking is less than QTY on hand. • QTY user is picking is detail allocated. The system prevents users from picking inventory that is detail allocated to prevent the creation of stranded detail allocations. <p>For alternatives:</p> <ul style="list-style-type: none"> • Use pick by Picklist method to pick detail allocations. • Remove detail allocations.

Material Transfer

Use this transaction to maintain detail allocations against production orders when transferring inventory.

This parent transaction manages production material transfer (no picking) for production orders functionality. It replaces all prior transactions related to material picking and issuing developed for 2016 and 2017 EE.

Primary Configuration

The primary configuration for this transaction supports and incorporates all prior early adopter Automated Solutions standard library transaction replenishment transfer methods, including the following:

- Production order transfer
- Production order kit transfer
- Production order picklist

Limitations/Exceptions

- Production order pick/transfer/issue must be performed prior to using the Production Material Request transaction.
- Production order picklist pick and transfer does not support the concept of kitting; therefore, the kitting solution does not include picklists
- Production Orders Allocation Maintenance does not include functions for picked or unpicked; therefore, when transferring against a production order, only components with existing detail allocations can be transferred.
- The system displays picklists only for the login site.
- The picklist ID must be valid for the user login site.

Transfer by Order Method

- Order Status must be A or R and Order Type must be blank or S.
- Orders must have linked Serial ID KITS available to transfer.

Transfer by Picklist Pick Method

- Picklists must be open picklist from the login site.
- The pick quantity must be greater than 0 (zero).

Material Transfer

- Locations must have inventory that is detail allocated (picked) for the selected production order picklist.
- Excludes production line or work center backflush locations.
- For production order transfers, all serial IDs cannot be moved to the work center/production line backflush location.

Minimum System Setup

QAD Serialization

You must install and enable QAD Serialization to pick by a serialized pack. For information on installing the correct version of QAD Serialization with the Production Orders version you use, refer to the *QAD Production Orders Installation Guide* for your version.

Transfer Allocation Policy

You should set the Transfer Allocation Policy in the Item Picking Data frame in Item Master Maintenance, Item Inventory Data Maintenance, or Item-Site Inventory Data Maintenance.

For Pick by Location:

- QAD Warehousing must be installed and enabled.
- The system defines replenishment locations, minimum, and maximum by item.

For Pick by Picklist:

- Item master or item-site Allocation Policy must be set to General.
- Item master or item-site Pick Policy must not be set to No Pick.
- The item BOM must be associated with the routing operation of a work center with a backflush location.
- The item needs to exist on the selected production order bill of material.

For Pick by Production Order:

- Released discrete or scheduled orders
- Available Inventory to pick
- Production order component demand must be greater than the detail allocated quantity

For Pick by Order - Kitting:

- Pack code for a kit set up in Pack Code Maintenance
- Packing structure for a kit set up in Packaging Structure Maintenance (13.14.4)
- Serial ID range setup for a kit; set up kit prefixes to distinguish temporary kit IDs from inventory and item serial IDs

Transaction Technical

DC Menu	DC Menu Name	DC Transaction Technical Name	Production Order .NET Menu Action
5.1.4	Production	Material Transfer	Trans: Production Order Transfer Parent App: Calls linked transactions <ul style="list-style-type: none"> • Production Order Manual Allocation (16.5.2, womall.p) • Production Order Picklist Transfer (16.5.9, wopkis.p) • Inventory Transfer (3.4.3, iclotr03.p) • Pack Transfer (3.17.8, papatr02.p) • Pack Decommission (3.17.6, papadecm.p)

Flow Chart

Fig. 5.10
Production Material Transfer (Parent)

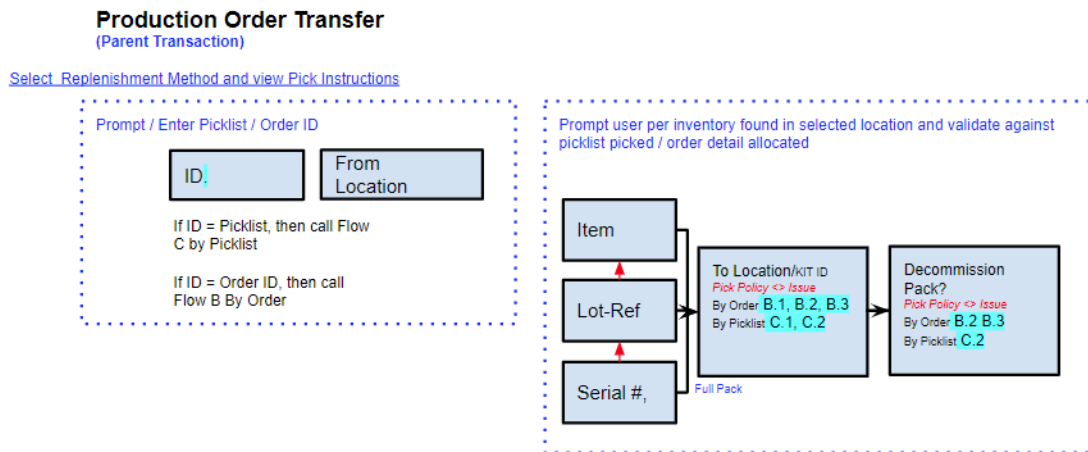
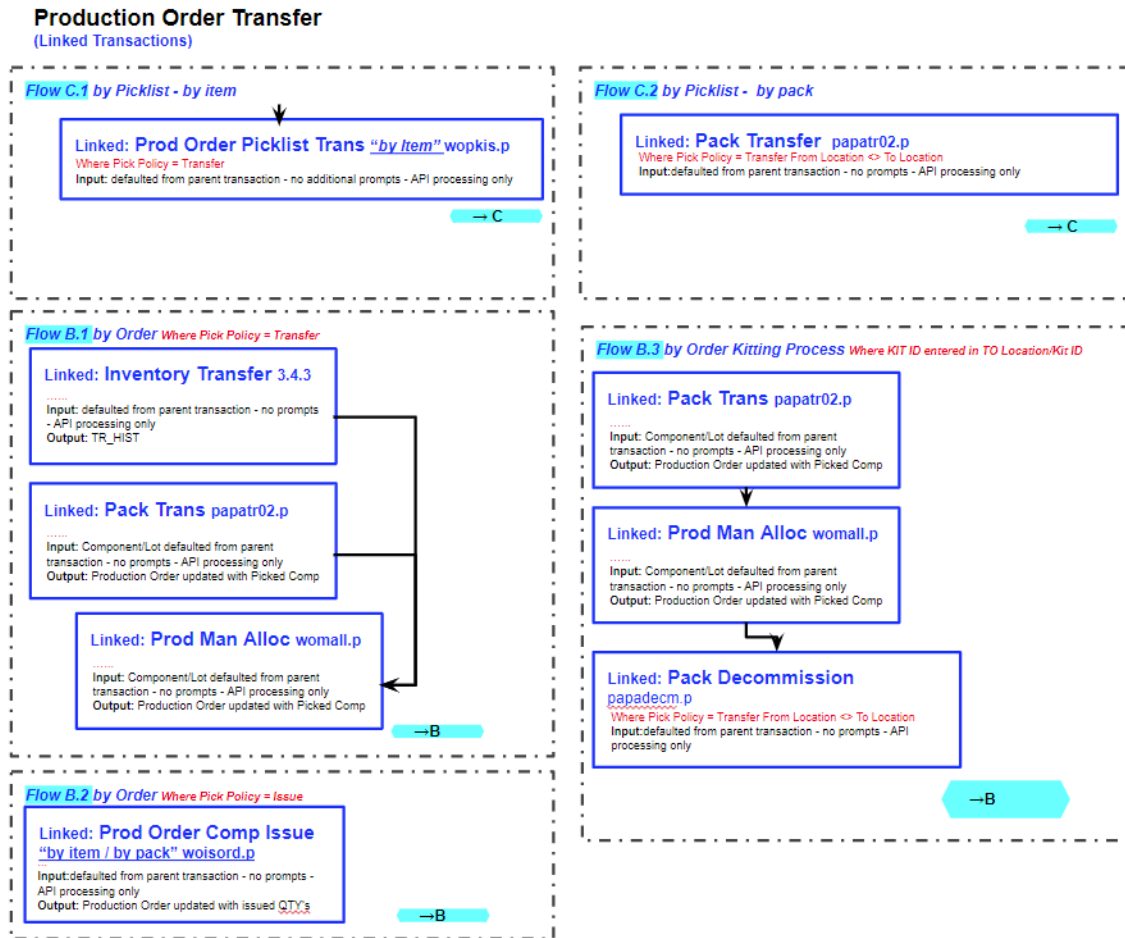

Fig. 5.11
Production Material Transfer (Linked)



Field Information

This section contains field level details for the following parent and linked transactions:

- Production Order Pick/Transfer - Parent Transaction
- Transfer by Order Method - Parent Transaction
- Transfer by Picklist Pick Method - Parent Transaction
- Transfer Item/Lot/Serial for Detail Allocated Components - Parent Transaction
- Linked Transactions - Pick by Order - Transfer with Kitting Flow

Production Order Pick/Transfer - Parent Transaction

Use the Production Order/Transfer parent transaction to determine the following:

- The picking method they will work on.
- The information required to process linked transactions related to transfer of picked inventory.

- Manages all linked transactions with the primary purpose of minimizing partial/failed transaction processing by gathering all possible data up-front and using pre-validations before invoking linked transactions.

Field Name	Comments
tt...	
Site	Defaulted per user log-in (Hidden Field).
Replenishment Method (Data entry field)	<p>Select Replenishment Method.</p> <p>Validations: Method exists per look-up.</p> <p>Look-up Name: Replenishment Method</p> <p>Auto-display: Yes</p> <p>Default Selected Values: Request Type, Request Method</p> <p>Look-up Query Rules: Eventually, may create generalized codes to define by site the methods available.</p> <p>Look-up Fields:</p> <ul style="list-style-type: none"> • Requests: Number of records found in DB/Site for Request Type<i>Line Side Direct</i>: records per DCworkfile containing Line Side Replenishment Requests<i>Line Side Bulk</i>: See Work Center Bulk Replenishment logic<i>By Production Order</i>:<i>By Picklist</i>: Total open picklists with open pick requirements • Request Type • Active Pickers • Method ID (Sort 1 Ascending)
ID (Data entry field)	<p>Select Picklist or Order to transfer.</p> <p>Validation: Picklist ID is valid per user log-in site.</p> <p>Look-up Name: Picklist</p> <p>Auto-display: Yes</p> <p>Default Selected Values: Picklist Number and Sequence</p> <p>Look-up Query Rules:</p> <ul style="list-style-type: none"> • Find/display picklists where log-in site = picklist site • Where picklist pick qty > 0 <p>Look-up Fields:</p> <ul style="list-style-type: none"> • (P) Picker: Displays user ID per user who has selected this item to pick. • ID (Sort 1 ascending): As defined on the picklist. Currently represents production line. • Type • To Location: Displays first location found in picklist where picklist materials are to be transferred to. • Open Trans: Displays number of items to pick for picklist • Seq: Picklist sequence number • Type • Order ID: First order ID displayed for picklists • Created: Date picklist created

Transfer by Order Method - Parent Transaction

Gather information required to process linked transactions related to production order transfer. Prior to being able to transfer, the user will have already picked the material.

The following limits/exceptions apply to this transaction:

- Order Status must be A or R and Order Type must be blank or S.
- Orders must have linked Serial ID KITS available to transfer.
- Configuration is limited to transferring only picked KITS use case.

The following fields only apply if the *By Order* replenishment method is selected.

Field Name	Comments
ttOrder - By Production Order Method	
Order ID <i>(Data entry field)</i>	Input/scan Order ID. Validation: <ul style="list-style-type: none"> • Valid Order ID • Order Status = A,R • Order has linked KITS (Serial ID's) Look-up Name: Orders to Transfer Auto-display: Yes Default Selected Values: Order ID Look-up Query Rules: <ul style="list-style-type: none"> • Display where Order Status = "A,R" and order Type = "blank" or "S" • Order has linked Serial ID KITS, available to transfer Look-up Fields: <ul style="list-style-type: none"> • Order ID (Sort 1 ascending) • Number of Transfers: # of components detail allocated per order

Transfer by Picklist Pick Method - Parent Transaction

Parent transaction will gather information required to process linked transactions related to production order picking transfer.

Background: Picklist method uses picklists as the directive input for picking. Once material is picked, this transaction is configured to support the transfer of PICKED / KITTED ITEMS ONLY.

The transaction performed prior to this transaction would be Production Order Pick/Transfer/Issue.

The following fields only apply if the *By Picklist* replenishment method is selected.

Field Name	Comments
ttPicklist - Transfer by Picklist Pick Method	
Picklist <i>(Data entry field)</i>	Select Picklist to Transfer. Validation: Picklist ID valid per user log-in site. Look-up Name: Picklist Auto-display: Yes Default Selected Values: Picklist Number and Sequence Look-up Query Rules: <ul style="list-style-type: none"> Find/display picklists where log-in site = picklist site Where picklist pick qty > 0 Look-up Fields: <ul style="list-style-type: none"> (P) Picker: Displays user ID per user whom has selected this item to pick. Picklist (Sort 1 ascending): Open picklist for log-in site Resource: As defined on the picklist. Currently represents production line. To Location: Displays first location found in picklist where picklist materials are to be transferred to. Open Trans: Displays number of items to pick for picklist. Sequence (Sort 2 ascending): Picklist sequence number Type Order ID: First order ID displayed for picklists Created: Date picklist created
Pick Sequence	Defaulted per prior field look-up. Prompt if user did not select from prior look-up.
Pick Allocated	Default = No (Hidden Field)
Effective Date	Default = Today (Hidden Field)
Use To Location Status	Default = Yes (Hidden Field)
Remove Untransferred Picklist QTY	Default = No (Hidden Field)

Transfer Item/Lot/Serial for Detail Allocated Components - Parent Transaction

This transaction provides user ability to move material to another location for detail allocated/picked components that have already been picked per a picklist or production order. If user has not picked/detail allocated materials, this is not the correct transaction to use.

The user selects the location they will transfer from and physically go to that location. Arriving at the location, the user will pick the material. User then goes to the destination location and scans the destination location bar code to confirm delivery of the material.

The following limits/exceptions apply to this transaction:

- Locations must have inventory that is detail allocated (picked) for the selected production order picklist.
- Excludes production line or work center backflush locations.
- For production order transfers, all serial IDs cannot be moved to the work center/production line backflush location.

The following fields apply to all picking methods. In cases where the picking method has specific rules/validations, the differences are noted below.

Field Name	Comments
ttOrder ttPicklist Pick Item/Lot/Serial ID	
Picklist	Redisplay if Pick Method = Picklist
Order ID	Redisplay if Pick Method = Order
Location From <i>(Data entry field)</i>	<p>Scan/Enter location moving materials from.</p> <p>Validation: Location is valid and not restricted (see location restrictions logic).</p> <p>Look-up Name: Transfer From Location</p> <p>Auto-display: Yes</p> <p>Default Selected Values: Location</p> <p>Look-up Query Rules: Displays the locations where inventory is detail allocated (picked) for the selected production order/picklist.</p> <ul style="list-style-type: none"> • Where selected picklist/order has components with picked QTYs / detail allocations • Excludes locations defined as Production Line 16.1.1, splnmt.p ln_mstr.ln_backflush_loc and Work center 14.5, rwwcmt.p, wc_mstr.wc_backflush_loc backflush locations. <p>Look-up Fields:</p> <ul style="list-style-type: none"> • Current Location: Location of component detail allocation of production order / picklist • Ord Det Alloc: Detail allocations for selected production order/picklist • Destination Location: <ul style="list-style-type: none"><i>For picklists:</i> The destination location defined on the picklist.<i>For production orders:</i> The work center/production line backflush location defined on the production order for the component and BOM operation. <p>Note: The following fields are prompted based on the inventory available in the selected pick from location.</p> <ul style="list-style-type: none"> • Consideration 1: Prompt for Item/pack serial ID if serialized inventory exists • Consideration 2: Prompt for Lot/Serial if loose inventory exists • Consideration 3: Prompt for Item Number & Quantity if loose inventory exists

Field Name	Comments
Serial ID <i>(Data entry field)</i>	<p>Scan/Enter Item/Pack Serial ID to pick per prior selected item/location to pick. Prompt only when selected From Location has serial IDs.</p> <p>Validations:</p> <ul style="list-style-type: none"> • Record exists • All components in the Serial Pack are allocated to the selected production order/picklist. • Only permit user to select the detail allocated inventory for selected order/picklist. <p>Validations for KIT ID (Kitting)</p> <ul style="list-style-type: none"> • KIT ID associated to Order ID. • KITID stage =active <p>Look-up Name: Serial ID</p> <p>Auto-display: No</p> <p>Default Selected Values: Serial</p> <p>Look-up Query Rules:</p> <ul style="list-style-type: none"> • All serial IDs that have detail allocations associated to selected order/picklist. • For Transfer by Production Order, all serial IDs that are not yet moved to the work center/production line backflush location. <p>Look-up Fields:</p> <ul style="list-style-type: none"> • DA (Sort 1 descending): Displays “Y/N” if OPEN detail allocations exists for selected component per the Order/Picklist. • Ord Det Alloc: Detail allocations for component/order. • Serial: Inventory serial ID record. • Pack QTY: Quantity in Pack (serial ID) • Stage: Stage of Serial ID (Active, Picked) • Type: Is the serial ID a package or item serial ID? • Allocation ID: Displays the Picklist ID or Order ID the material is detail allocated to. • QOH: Quantity on Hand • Expire: Oldest expire date of lot in pack. • Serial Date (Sort 2 ascending): Serial Detail - record create dateOrder Detail Allocated: QTY detail allocated to an order in pack • Location Status (Loc St): Location Status. • Location: Inventory location with available inventory to pick.

Field Name	Comments
Lot <i>(Data entry field)</i>	Scan/Enter Lot/Serial. Prompt only when selected From Location has LOT/Refs. Validations: <ul style="list-style-type: none"> • Record exists. • All components in the Serial Pack are allocated to the selected production order/picklist. • Only permit user to select the detail allocated inventory for selected order/picklist. Look-up Name: Lot/Ref ID Auto-display: No Default Selected Values: Lot/Ref Look-up Query Rules: <ul style="list-style-type: none"> • Records per selected location. • All records that have detail allocations to selected order/picklist. • For Transfer by Production Order, all serial IDs that are not yet moved to the work center/production line backflush location. Look-up Field Details: <ul style="list-style-type: none"> • DA (Sort 1 ascending): Displays “Y/N” if OPEN Alloc detail allocations exists for serial record for THIS ORDER/PICKLIST • Order Detail Allocated: QTY detail allocated to an order in pack. • Lot/Serial (Sort 2 ascending) (x10): Displays lot ID. • Serial: Inventory serial ID record • Pack QTY (x10): Quantity in Pack (serial ID) • Allocated Order: Displays the Picklist ID or Order ID the material is detail allocated to. • Created: The data the serial ID was created. • Location Status (Loc St) • Location • Stage: Stage of Serial ID (Active, Picked) • Type: Is the serial ID a package or item serial ID?
Reference	Same rules/look-up as prior look-up.
Item to Pick <i>(Data entry field)</i>	Scan/Enter Item to pick per prior selected item to pick. Validations: <ul style="list-style-type: none"> • Item is valid per site. • Item has detail allocation (has been picked /transferred prior). Look-up Name: Item Auto-display: No Default Selected Values: Item Look-up Query Rules: <ul style="list-style-type: none"> • Records per selected location. • All records which have detail allocations to selected order/picklist. • For Transfer by Production Order, all serial IDs which are not yet moved to the work center/production line backflush location.
Operation <i>(Data entry field)</i>	Conditional prompt: If selected lot/item is applicable to multiple operation and with different backflush locations. Conditional prompt not applicable for Serial/KIT IDs.

Field Name	Comments
Quantity	<p>Where qty = lesser of detail allocated QTY or QTY available to transfer per location's item, lot, unit pack.</p> <p>In the case where a BOM has multiple operations of the same component, the defaulted QTY will be the total across related operations.</p> <p>Validate:</p> <ul style="list-style-type: none">• QTY > 0• Validate inventory is available• Error message: Not enough inventory for <item number> in location <location> <p>Lookup Fields:</p> <ul style="list-style-type: none">• Order• Item• Loc• Lot• Allocations

Field Name	Comments
Location To <i>(Data entry field)</i>	<p>Default quantity to transfer per picklist/order detail allocations of selected Serial/Lot/Item.</p> <p>Prompt/Scan Location To.</p> <p>Do not prompt or display if: Pick Policy = Issue</p> <p>Default value rules based on Replenishment Method:</p> <ul style="list-style-type: none"> • By Order: Default work center/production line backflush locations. • By Picklist: Default destination location per Picklist. When the pick policy = issue, do not prompt for TO Location. Display only the destination location per picklist. Default Operation should be per BOM operation defined on routing. <p>General Validations: Location is valid and not restricted to move to</p> <p>Validations for Pick Method = By Picklist</p> <ul style="list-style-type: none"> • API does support ability to change the TO Location. • Validation if user changes destination location not equal to Picklist destination location. <p>Validations for KIT ID (Kitting)</p> <ul style="list-style-type: none"> • KIT ID associated to Order ID. • Location Type must equal the Type of the From location of picked item • KITID stage = new/active • If user enters the value “KIT”, this will trigger the prompt, Create KIT ID? If the KIT setup has not been completed, display error, “KIT setup not found” If users responds “Y”, then perform the KIT Pack Create <p>Look-up Name: Move To Location</p> <p>Auto-display: No</p> <p>Default Selected Values: Serial</p> <p>Look-up Query Rules:</p> <ul style="list-style-type: none"> • Display per Picklist Transfer To Location • Display per Production Order Transfer To Location = production order routing work center location = production order routing production line location <p>Look-up Fields:</p> <ul style="list-style-type: none"> • Location: Location user should move to. • Resource • Description • Seq (Sort 1 ascending): The locations the user should move the material to in sequence of priority ...1 - Work Center Backflush location ...2 - Production Line Backflush location ...3 - Work Center Reserved Locations ...4- Production Line Reserved Locations

Linked Transactions - Pick by Order - Transfer with Kitting Flow

This grouping of linked transactions relates to the Pick by Order with Kitting Flow. The approach / method is to process a negative detail allocation for every item/lot/serial within the KIT (PACK) per the From Location and then reprocess for same for the updated TO Location when the KIT (Pack) is transferred.

- **Linked - Pack Transfer.** When a KIT (Pack) is transferred, we use the standard Pack Transfer program.

Field Name	Comments
tt... Pack Transfer	
Serial ID	Default from parent transaction, Location To/KIT ID field or Pack Create in the event a new KIT ID is created
Transfer To Site	Default from parent transaction (= user log-in site)
Location	Default from parent transaction (Location = KIT)

- **Linked - Production Order Manual Allocation.** After the KIT it transferred, we update the Detail Allocations of all components in the KIT related to the production order of the KIT.

Field Name	Comments
tt... Production Order Manual Allocation	
ID	Default value = selected order in parent buffer
Component	Default value = selected picked item in parent buffer
Operation	Defaults per the BOM Routing field If Item BOM operation value does not match the Item Routing the API will accept this. For example, if the BOM operation = 0 but the Item Routing does not have an operation = 0.
Location	Default value = Location TO (the location user transferred material to that is defined in parent buffer)
Lot/Serial	Default value = selected picked Lot/Serial in parent buffer
Reference	Default value = selected picked Lot/Serial in parent buffer
Quantity Allocated	Default value = selected picked Lot/Serial in parent buffer Note: If the QTY picked is greater than the QTY Required, the API does not permit allocating more than QTY required. The AS configuration, therefore, will allocate the lessor of QTY Picked or QTY Required. This allows a user to pick and transfer quantities greater than qty required. Note: When we update the detail allocated after an inventory transfer of the component/KIT, we first do a negative QTY for the component/lot From location and then perform a positive transaction for the new destination location. We do not use the Deallocate field because this will deallocate all records for a selected component—which is not the desired result.
Quantity Picked	The API does not currently support updating the Quantity Picked directly.

- **Linked - Production Order Manual Allocation.** After the KIT it transferred, we update the Detail Allocations of all components in the KIT, related to the production order of the KIT.

Field Name	Comments
tt... Production Order Manual Allocation	
ID	Default value = selected order in parent buffer
Component	Default value = selected picked item in parent buffer
Operation	Defaults per the BOM Routing field If Item BOM operation value does not match the Item Routing, the API will accept this. For example, if the BOM operation = 0 but the Item Routing does not have an operation = 0.
Location	Default value = Location TO (the location user transferred material to that is defined in parent buffer)
Lot/Serial	Default value = selected picked Lot/Serial in parent buffer
Reference	Default value = selected picked Lot/Serial in parent buffer

Field Name	Comments
Quantity Allocated	<p>Default value = selected picked Lot/Serial in parent buffer</p> <p>Note: If the QTY picked is greater than the QTY Required, the API does not permit allocating more than QTY required. The AS configuration, therefore, will allocate the lesser of QTY Picked or QTY Required. This allows a user to pick and transfer quantities greater than qty required.</p> <p>Note: When we update the detail allocated after an inventory transfer of the component/KIT, we first do a negative QTY for the component/lot From location and then perform a positive transaction for the new destination location. We do not use the Deallocate field because this will deallocate all records for a selected component—which is not the desired result.</p>
Quantity Picked	The API does not currently support updating the Quantity Picked directly.

- **Linked - Production Order Pick/Transfer**

Field Name	Comments
tt... Production Order Pick Transfer	
Item Number	Default value = selected picked item in prior buffer fields
Backflush Location	Default value = To Location select in prior buffer fields
Total Transaction QTY	Default value = Picked QTY entered in prior buffer fields
Remove Untransfer Picklist QTY	Default = No (Hidden Field)

- **Linked - Inventory Transfer**

Field Name	Comments
tt... Inventory Transfer	
Item Number	Default value = selected picked item in prior buffer fields

- **Linked - Pack Transfer with Lot/Serial Change**

Field Name	Comments
tt... Pack Transfer with Lot/Serial Change	
Item Number	Default value = selected picked item in prior buffer fields

Material Issue

Use this transaction to issue materials to production orders. This parent transaction manages all forms of production material Issue (no picking) for our new Production Orders functionality. It replaces all prior transactions related to material issuing developed for 2017 EE and prior versions.

This solution design supports and uplifts all prior early adopter AS standard library transaction component issue, including the addition of new production order picklists.

- By Order
- By Picklist

Transaction Technical

DC Menu	DC Menu Name	DC Transaction Technical Name	Production Order .NET Menu Action
5.1.5	Production	Pack Create by Pack Code	Trans: Production Order Parent Component Issue App: Calls linked transactions <ul style="list-style-type: none"> • Production Order Picklist Issue by Item (16.5.11, woispck.p) • Production Order Picklist Issue by Pack (16.5.11, woispck.p) • Production Order Component Issue (16.5.11, woispck.p)

Limitations / Exceptions

- Does not support issuing from a pack where multiple items/lots exist.
- If using Production Order Picklists, Production Order Pick/Transfer/Issue must be performed prior to using this transaction.

Issue by Order Method

- Production Order Pick/Transfer/Issue transaction must be performed before this transaction.
- Order Status must be A, R and order Type must be blank or S.
- Order has linked Serial ID KITS, available to issue against.

Issue by Picklist Method

- Production Order Pick/Transfer/Issue transaction must be performed before this transaction.
- This transaction is only for picked items not transferred.
- The login site must be the same as the picklist site.
- The picklist quantity must be greater than 0 (zero).

Issue Item/Lot/Serial for Detail Allocated Components

- Materials must be picked or detail allocated.
- The location cannot be restricted.
- Quantity must be greater than 0 (zero).

Minimum System Setup

N/A

Minimum Data Required

N/A

Transaction Flow Chart

Fig. 5.12
Material Issue

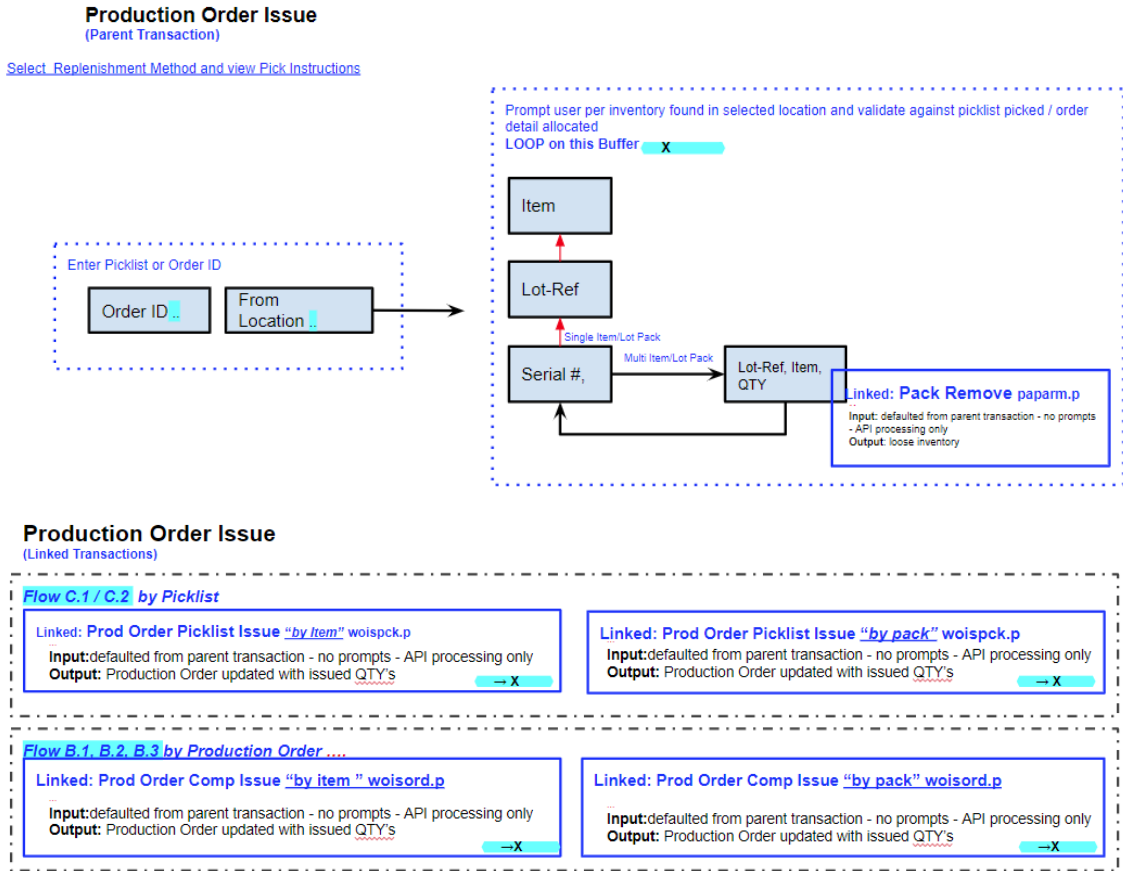

Field Information

Transaction Detail - Production Order Issue (Parent)

Parent transaction will look at user to determine:

- The picking method they will work on.
- Gather information required to process linked transactions related to component issue.
- Manages all linked transactions with primary purpose of minimizing partial/failed transaction processing by gathering all possible data up-front and using pre-validations before invoking linked transactions.

The following fields apply to the parent transaction and buffer.

Field Name	Comments
tt... - Production Order Issue	

Field Name	Comments
Site	Defaulted per user log-in (Hidden Field).
Replenishment Method (Data entry field)	<p>Select Replenishment Method.</p> <p>Validations: Method exists per look-up</p> <p>Look-up Name: Replenishment Method</p> <p>Auto-display: Yes</p> <p>Default Selected Values: Request Type, Request Method</p> <p>Look-up Query Rules: N/A</p> <p>Look-up Fields:</p> <ul style="list-style-type: none"> Request Type: By Production Order or By Picklist Method ID (Sort 1 Ascending) <ul style="list-style-type: none">5 (by Production Order)7 (by Picklist)

Transaction Detail - Issue by Order Method (Parent)

Gather information required to process linked transactions related to Production Order issue. Prior to being able to issue, the user will have already picked and transferred the material to the usage location.

Note Configuration is limited to the use case where users issue only picked KITS.

The following fields apply specifically when the *By Order* replenishment method is selected.

Field Name	Comments
tt... - Issue by Order Method	
Order ID (Data entry field)	<p>Input/scan Order ID.</p> <p>Validation:</p> <ul style="list-style-type: none"> Valid Order ID Order Status = A,R <p>Look-up Name: Orders to Issue</p> <p>Auto-display: Yes</p> <p>Default Selected Values: Order ID</p> <p>Look-up Query Rules:</p> <ul style="list-style-type: none"> Display where Order Status = "A,R" and order Type = "blank" or "S" Order has linked Serial ID KITS, available to transfer <p>Look-up Fields:</p> <ul style="list-style-type: none"> Order ID (Sort 1 ascending) Number of Issues: Number of detail allocated components open to issue order against.

Transaction Detail - Issue by Picklist Method (Parent)

This transaction gathers information required to process linked transactions related to Production Order picking Issue.

Background: Picklist method uses picklists as the directive input for picking. Once material is picked, this transaction is configured to support the issue of PICKED ITEMS ONLY which have NOT BEEN TRANSFERRED.

If the materials have been transferred, then use Issue by Production order method to issue components with Issue Policy = Direct.

The following fields apply specifically when the *By Picklist* replenishment method is selected.

Field Name	Comments
tt... - Issue by Picklist Method	
Picklist <i>(Data entry field)</i>	Select Picklist to issue. Validation: Picklist ID valid per user log-in site. Look-up Name: Picklist Auto-display: Yes Default Selected Values: Picklist Number and Sequence Look-up Query Rules: <ul style="list-style-type: none"> Find/display picklists where log-in site = picklist site Where picklist pick qty > 0. Note: If you transfer what you picked, the QTY picked is set to 0. Look-up Fields: <ul style="list-style-type: none"> Picklist (Sort 1 ascending): Open picklist for log-in site. Sequence (Sort 2 ascending): Picklist sequence number. Type Order ID: First order ID displayed for picklists. Created: Date picklist created.
Pick Sequence	Defaulted per prior field look-up. Prompt if user did not select from prior look-up.
Pick Allocated	Default = No (Hidden Field)
Effective Date	Default = Today (Hidden Field)
Use To Location Status	Default = Yes (Hidden Field)
Remove Untransferred Picklist QTY	Default = No (Hidden Field)

Transaction Detail - Issue Item/Lot/Serial for Detail Allocated Components (Parent)

This transaction provides the user the ability to allocate the material for detail allocated/picked components that have already been picked per a picklist or production order. If user has not picked/detail allocated materials, this is not the correct transaction to use.

The user selects the location they will transfer from and physically goes to that location. Arriving at the location, the user will pick the material. The user then goes to the destination location and scans the destination location bar code, to confirm delivery of the material.

The following fields apply to all picking methods. In cases where the picking method has specific rules/validations, these differences will be noted below.

Field Name	Comments
tt... - Issue Item/Lot/Serial for Detail Allocated Components	
Picklist	Redisplay if Pick Method = Picklist
Order ID	Redisplay if Pick Method = Order

Field Name	Comments
Location From <i>(Data entry field)</i>	<p>Scan/Enter location issuing materials from.</p> <p>Validation: Location is valid and not restricted.</p> <p>Default the backflush location based on standard API behavior:</p> <ul style="list-style-type: none"> • Backflush Location from the work center location, wc_mstr.wc_backflush_loc • Backflush Location from the Production line ln_mstr.ln_backflush_loc, when a production line is referenced on the scheduled / discrete production order <p>Lookup Name: From Location</p> <p>Auto-display: No</p> <p>Default Selected Values: Location</p> <p>Look-up Query Rules: Displays the locations where inventory is detail allocated (picked) for the selected production order / picklist. Where selected picklist/order has components with picked QTYs / detail allocations</p> <p>Look-up Fields:</p> <ul style="list-style-type: none"> • Current Location: Location of component detail allocation of production order/picklist • Picked Item • Picked Qty • Destination Location: <ul style="list-style-type: none"><i>For picklists:</i> The destination location defined on the picklist.<i>For production orders:</i> The work center/production line backflush location defined on the production order for the component and BOM operation. • Pick Policy <p>Note: The following fields are prompted based on the inventory available in the selected pick from location.</p> <ul style="list-style-type: none"> • Consideration 1: Prompt for Item/pack serial ID if serialized inventory exists • Consideration 2: Prompt for Lot/Serial if loose inventory exists • Consideration 3: Prompt for Item Number & Quantity if loose inventory exists
	<p>General Validations:</p> <ul style="list-style-type: none"> • Issue Policy <> 0,1 “do not issue”, “backflush” per 1.4.16 field “issuePolicyDisp” • Issue Policy <> • Item is defined on Production Order BOM • Item is defined on Picklist per Production Order

Field Name	Comments
Serial ID <i>(Data entry field)</i>	Scan/Enter Item/Pack Serial ID to pick per prior selected item/location to pick. Prompt only when selected From Location has serial IDs. Limitations: Does not support multi-item/lot/unit packs in a pack. Validations: <ul style="list-style-type: none"> • Valid Serial ID • Stage = Active • Serial ID with single item is applicable to selected order operation • Validate selected Serial ID is not a multi-item/lot pack. • Validate where Issue Policy = no issue • Serial ID/QTY is not fully detail allocated to another order/picklist • Serial ID is picked/allocated to selected picklist Look-up Name: Serial ID Auto-display: No Default Selected Values: Serial Look-up Query Rules: Find/display serial IDs per selected location. Lookup Fields: <ul style="list-style-type: none"> • Serial: Inventory serial ID record. • Pack QTY: Quantity in Pack (serial ID) • Stage: Stage of Serial ID (Active, Picked)
Lot <i>(Data entry field)</i>	Scan/Enter Lot/Serial. Prompt only when selected From Location has Lot/Refs Validations: <ul style="list-style-type: none"> • Item can be issued to selected operation. • Record exists. • Validate where Issue Policy = no issue. • There is enough loose inventory to issue. • Lot QTY is not fully detail allocated to another order/picklist. • Lot is picked/allocated to selected picklist. Lookup Name: Lot Auto-display: No Default Selected Values: Lot Look-up Query Rules: Find/display Lots per selected location. Look-up Field Details: <ul style="list-style-type: none"> • Lot/Serial (Sort 2 ascending) (x10): Displays lot ID. • Reference • Quantity on Hand • Location Status (Loc St)
Reference <i>(Data entry field)</i>	Scan/Enter Reference ID. Prompt only when selected From Location has lots with reference. Same rules/look-up as prior LOT field in addition to: Validations: Reference is valid. Look-up Name: Ref Auto-display: No Default Selected Values: Ref Look-up Query Rules: Find/display Ref per selected location

Field Name	Comments
Item Number (Data entry field)	<p>Scan/Enter Item.</p> <p>Prompt only when selected From Location has loose items per selected order/picklist</p> <p>Validations:</p> <ul style="list-style-type: none"> • Item can be issued to selected operation. • Record exists. • There is enough loose inventory to issue. • Validate where Issue Policy = no issue. • Item/QTY is not fully detail allocated to another order/picklist • Item QTY is picked/allocated to selected picklist <p>Look-up Name: Components</p> <p>Auto-display: No</p> <p>Default Selected Values: Item Number</p> <p>Look-up Query Rules: Look-up only shows item which have pick policy as issue, the order that you are using does not have any item with pick policy as issue.</p>
Required	<p>Display Gross Req.</p> <p>Required = [Qty Required - Quantity Issued] where >0</p>
Quantity to Issue	<p>Input quantity to transfer if transferred unit is not a Serialized Pack</p> <p>Rules Specific To Issue by Order</p> <p>Default: quantity; where qty = lesser of detail allocated QTY, Required To Issue, QTY available to issue per location's:</p> <ul style="list-style-type: none"> • Serial ID • LOT/Ref • Item number <p>Rules Specific To Issue by Picklist</p> <p>Default: default quantity; where qty = lessor of picked QTY, QTY available to transfer per location's item,lot,unit pack</p> <p>General Validations:</p> <ul style="list-style-type: none"> • Zero not allowed • Validate inventory is available.

Production Packaging

This transaction creates serial IDs or a package for production orders.

This parent transaction manages packaging for production orders and replaces all prior transactions related to production packaging for 2017 EE and prior versions.

Primary Configuration

The primary configuration supports packaging by production order from a .NET Production Order Shop Floor Collection.

The transaction includes a production order packaging parent that links to Pack Create by Production Orders, by Production Line, and Pack Build functions.

Limitations/Exceptions

- This transaction does not support Pack Create by Production Line functions.

Minimum System Setup

N/A

Minimum Data Required

N/A

Transaction Technical

DC Menu	DC Menu Name	DC Transaction Technical Name	Production Order .NET Menu Action
5.1.6	Production	Packaging	Trans: Production Order Packaging Parent App: Calls linked transactions <ul style="list-style-type: none"> • Pack Create by Production Order 16.5.17, pawocr.p • Pack Create by Production Line (16.5.18, palncr.p) • Pack Build (3.17.3, papabd.p)

Flow Chart

Fig. 5.13
Production Packaging

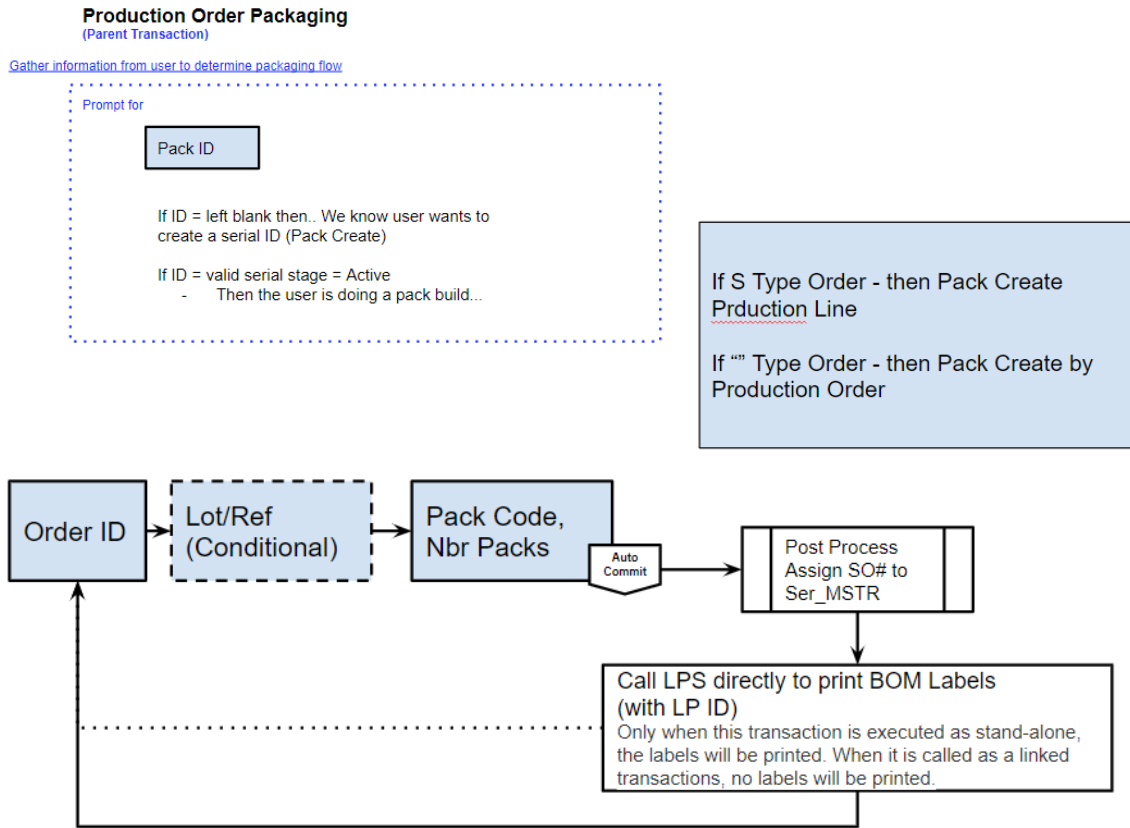

Note: Lot and Reference are conditional fields, triggered by an item being Lot controlled. If item is NOT Lot controlled, Printer loops back to Pack Code.

Pack Build 3.17.3 papabd.p

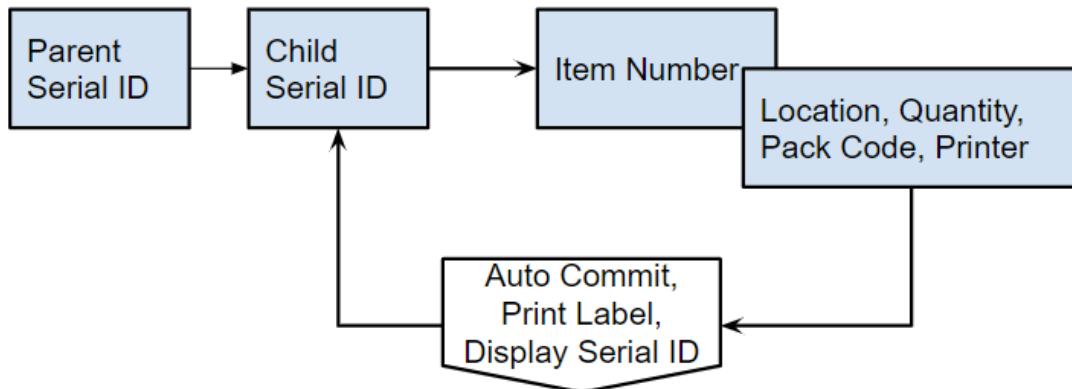

Field Information

Production Order Pick/Transfer - Parent Transaction

The parent transaction will determine the user intention: create a pack label, add items to a pack, build a pack, and so on.

The following fields apply to the parent transaction and buffer.

Field Name	Comments
tt... - Order Info	
dID	<p>This is a hidden field designed to accept the input of a value from the DC .NET UI (KeyID or TransactionKeyID) (integration)</p> <p>When this hidden field is populated, the transaction recognizes it is running within the .NET UI.</p> <ul style="list-style-type: none"> • The following WO ID field is populated with the ID value and the field is changed to non-updatable. • The first buffer of the transaction is changed to non-repeating. <p>Note: Assumes the transaction flow does not include in-processing looping. The user will perform a single transaction and be returned to the DC.NET frame.</p>
dItem	AUTO-Identify the operation the user is reporting at. EDL .NET: retrieve the operation from parent browse Operation browse field when running transaction within a .NET collection.
Order ID	Default from dID; otherwise enter/scan value
Item Number	Defaulted from order.
Pack ID	<p>Enter/Scan Pack ID</p> <ul style="list-style-type: none"> • If left blank and order type = Discrete, then call (existing but new name?) Pack Create by Production Order 16.5.17, pawocr.p • If left blank and order type = repetitive, then call (existing) Pack Create by Production Line 16.5.18, palncr.p • If valid existing pack ID entered (call ROP validation i.e., new or active status entered. allows multi item ect.), then call (existing) Pack Build 3.17.3, papabd.p

Linked - Pack Create by Production Order

Use this transaction to create serial pack IDs for selected production orders when users do not enter a Pack ID.

- The user prompts are based on the standard transaction.
- Default field values from parent transaction/browse such as: Item Number, Line and so on.
 - Default Pack Code - allow user to modify
 - Display Pack Code description
 - Prompt for Number of Packs

Field Name	Comments
tt... Pack Create by Production Order	

Linked - Pack Create by Production Line

If user does not enter a Pack ID, system will create serial pack IDs for selected production line.

- The user prompts are based on the standard transaction.

- Default field values from parent transaction/browse such as: Item Number, Line, and so on.
 - Default Pack Code - allow user to modify
 - Prompt for Number of Packs

Field Name	Comments
tt... Pack Create by Production Line	

Linked - Pack Build

Use this transaction to perform a pack build when users enter an existing Pack ID.

- The user prompts are based on the standard transaction.
- Default field values from parent transaction/browse such as Child Pack Serial ID and Item Number.
 - Prompt for Child serial
 - Prompt for Item if Child serial is blank
 - Prompt for Item (if Child serial is blank)
 - Prompt for Item Location (if Child Serial is blank)
 - Prompt for Lot/Serial (if Child Serial is blank and Item is lot/serial controlled)
 - Prompt for "Quantity to Pack"

Field Name	Comments
tt... Pack Build	

Production Receipts

This transaction supports packaged receipts including:

- Generating receipts
- Generating packs by production line
- Tracking scrap and reject quantities when receiving

You can run the Production Receipts transaction from simplified screens that let you quickly generate receipts. You can also run this receipt transaction from the Production Shop Floor Collection's Receipt tab.

Users are prompted to enter an ID for the receipt, and the ID can be any of the following:

- Serial ID created by production pack create by production line or production order
- Production order for released orders
- Production line
- Kanban consume/fill ID

Based on the type of ID you enter, the system can follow different flows that prompt for more details for the receipt. For example, when you enter the production line, the system prompts for the operation, employee number, and other information, but determines the production order for the transaction based on what the user enters. The following figure depicts the flow for the transaction when you enter a production line.

Fig. 5.14
Production Receipt with Production Line Flow

Seq	Selection
1	Material_Request
3	Material_Pick/Transfer/Issue
4	Material_Transfer
5	Material_Issue
6	Packaging
7	Production Receipts
9	Material Putaway
20	Internal Item Label

1. User selects Production, then Production Receipts (No 7.).

2. User enters the production order.

3. User enters the operation.

4. User enters the employee number; then, the quantity to receive, followed by quantity to scrap and reject.

5. The system prompts to create a pack.

6. The system prompts for location; once entered, it processes the receipt transaction.

Primary Configuration

Production Order API capabilities for receiving replaces the following 2017 EE and earlier-version transactions:

- Work Order Receipt (16.11)
- Work Order Receipt Backflush (16.12)
- Work Order Operation Backflush (16.19)
- Backflush Transaction (18.22.13)
- Labor Feedback by Work Center (16.20.3)
- Operation Scrap Transaction (16.20.7)

When you use the Production Receipt transaction, the system reports all associated information for the receipt, including the following data:

- Production order, production line, or kanban data
- Quantity and items received
- Materials issued
- Packaged receipts

When you select to create a pack during the receipt, the system prompts to create a serial ID. When you leave it blank, the system creates the ID using the BOP code. This flow is similar to the pack create flow in Production Activity Transaction, described in the Production Activities chapter of this user guide.

Limitations/Exceptions

- API does not support backflushing from a pack.
- Transaction does not prompt for attributes, report quality transactions, or pull Pre-Shipper Create by LP data.

Minimum System Setup

QAD Serialization

You must install and enable QAD Serialization to create serialized IDs or packs or to receive by a serialized pack. For information on installing the correct version of QAD Serialization with the Production Orders version you use, refer to the *QAD Production Orders Installation Guide* for your version.

Minimum Data Required

N/A

Transaction Technical

DC Menu	DC Menu Name	DC Transaction Technical Name	Production Order .NET Menu Action
5.1.7	Production	Production Receipts	Trans: Production Orders Reporting - Parent App: Calls linked transactions <ul style="list-style-type: none"> • Operation Activity Reporting • Kanban Consume/Post

Field Information

Note Some fields in the following table are disabled, defaulted by the system, or hidden, and therefore, are not recorded as RF scanner input; however, you can use the Automation Solutions framework to enable fields for data entry.

Field Name	Comments
ID	Identifies the production order, production order Serial ID, Kanban ID to report against Field is conditional: If reporting from .NET UI, then display only. If reporting from telnet, then prompt. Validation: <ul style="list-style-type: none"> • Order is valid (Production Order / Kanban) • Order status permits reporting (Production Order / Kanban) • Serial ID status is new/active & associated to a production order with a status permitting reporting.
Operation	Validations: Operation must exist per order routing

Field Name	Comments
Operation Activity Reporting:	
Site	Validations: Site must exist
Work Center	
Machine	
Item Number	
Employee	Validation: Employee code is valid
Routing	
BOM Code	
CUM ID	If order type = S, Display CUM ID of order being reported against Note: The Scheduled WO ID BOM & Routing Code will be applied to FIND or CREATE the CUM ORDER
Qty Open	
Last Entry	
Qty Processed	
Qty Complete	(Qty processed - QTY Scrapped) will result in correct QTY to backflush and receive into stock
UM	
Conversion	
Qty Scrapped	
Reason Code	Prompt if scrapped QTY entered
Qty Rejected	
Reason Code	Prompt if rejected QTY entered
Component	Validations: Item is valid per Order BOM Look-up only shows component with direct issue policy and QTY open to issue > 0
Location	
Lot	Conditionally prompt for LOT if selected location contains LOT. Lot number will default if Auto-Lot is enabled. Validations: <ul style="list-style-type: none"> • Item is valid per Order BOM • Item is NOT detail Allocated for a different order
Ref	Conditionally prompt for Ref if selected location contains Ref
QTY	Validations: (should be able to call a standard procedure) <ul style="list-style-type: none"> • Location overissue policy • Allocation rules validated: (QOH - QTY allocated to other orders) > QTY Entered • Inventory status
Build Pallet?	
Generate pack serial?	
“Parent Pack” Serial ID	If user enters value, validate pack is value and active or new status. If left blank, create new pack ID. <ul style="list-style-type: none"> • If user leaves pack ID blank, prompt and default Pack Code per item packaging setup

Field Name	Comments
“Unit Pack” Serial ID	<p>Prompt if user selects “Build Pallet = no”</p> <p>Default = blank</p> <p>If user enters value, validate pack is value and active or new status</p> <p>If left blank, create new pack ID</p> <ul style="list-style-type: none"> If user leaves pack ID blank, prompt and default Pack Code per item packaging setup
BOP Code	<p>If user leaves Serial ID blank, prompt and default BOP Code per item packaging setup</p> <p>Default BOP Code</p>
Quantity in Pack	
Lot	<p>During order receipt (last operation), prompt for item lot/serial when item is lot/serial controlled. Lot number will default if Auto-Lot is enabled.</p> <ol style="list-style-type: none"> Check Regulatory Attributes Control: <ul style="list-style-type: none"> If Lot Control Level = 2 and Item is serial controlled, THEN, must use Auto-Lot If Single Lot per WO Receipt (this is not applicable to AS) Default lot ID, “lotser” defined on production order, if BLANK THEN: Calculate per Auto-Lot-Group if enabled for item, pt_mstr_auto_lot, if NO THEN Default value = Production Order ID <ul style="list-style-type: none"> Setup required: set AutoLot = Yes and LotGroup = <blank>. Validate per Regulatory Attributes Control: If Lot Control Level = 1, validate LOT used per any of the following defaulting rules does not conflict
Location	<p>Default value = rules</p> <ol style="list-style-type: none"> = wo_loc defined on production order If wo_loc blank, then default work center backflush location If blank, then default production line backflush location If blank, then item site location pti_det.pti_loc If blank, then item master location

Production Item Putaway

This transaction lets you transfer items between locations and includes putaway logic.

Fig. 5.15
Item Putaway Overview

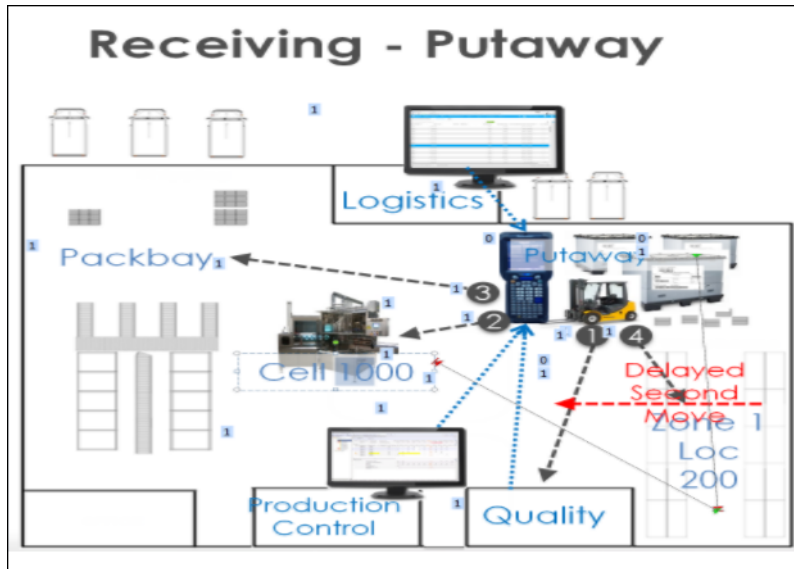

Primary Configuration

The putaway logic directs you to put inventory into locations available per your login site. The logic sifts through item and order data and includes putaway logic to direct you to move inventory to one or more locations.

Limitations/Exceptions

Note Requires implementation services to refine/develop putaway rules/logic. The putaway logic provided with this transaction is not supported and is used for reference only.

- This transaction cannot be restricted per Transfer Restriction Maintenance (36.3.7.1).
- This transaction does not directly support the following:
 - Consignment inventory
 - Electronic Signatures
 - Inter-site transfers that generate shipping documentation
 - Quality Inspection putaway decisions
 - Sales order picklists (pre-shippers/shippers)
- For locations:
 - Locations must be defined in the system as putaway locations.
 - Locations cannot have a 0 (zero) balance.
 - Locations cannot be restricted.
 - Locations must be valid for the login user and site.

Minimum System Setup

QAD Serialization

You must install and enable QAD Serialization to transfer or decommission by a serialized pack. For information on installing the correct version of QAD Serialization with the Production Orders version you use, refer to the *QAD Production Orders Installation Guide* for your version.

Generalized Codes

Since this transaction uses generalized codes for some shipping locations, such as default putaway shipping locations, you can optionally set up codes in Generalized Codes Maintenance (36.2.13) for putaway.

Minimum Data Required

To generate putaway requirements for sales orders:

- You must have an active sales order for the item.
- The quantity required in the shipping location must be less than the sales order quantity.

Transaction Technical

DC Menu	DC Menu Name	DC Transaction Technical Name	Production Order .NET Menu Action
5.1.9	Production	Material Putaway	Trans: Production Order Item Putaway <ul style="list-style-type: none"> • App: Transfer Single Item (3.4.3, iclotr03.p)

Field Information

Field Name	Comments
License Plate	<p>Prompts for license plate. When blank, then proceed to Item field; when entered, call Pack Transfer and prompt for Location To in Pack Transfer.</p> <p>Then call/use advanced putaway to location look-up within Pack Transfer.</p> <p>Validations:</p> <p>Same as Pack Transfer transaction.</p> <p>For the advanced putaway version, add validation to check for Generalized Codes setup for user site/log-in. When invalid, display error message.</p> <p>Look-up Name: Packs in Putaway Location</p> <p>Auto-display: No</p> <p>Look-up Query Rules: Displays the locations defined as putaway locations (see Generalized Codes setup)</p> <p>Look-up Fields:</p> <p>Location: Serial ID</p>
Item	<p>Input/lookup/scan of item number.</p> <p>Validation:</p> <p>For the advanced putaway, add validation to check for Generalized Codes setup for user site/log-in. When not valid, present error message, Generalized Code Not Defined.</p> <p>Look-up Name: Item Number</p> <p>Auto-display: No</p> <p>Look-up Fields:</p> <ul style="list-style-type: none"> • Item Number
Description	Description of input/scanned item.
Loc Zone	The default location type this inventory should be received into per Item Site/Item Master, QAD reserved pti_site_loc field.
UM	Unit of measure of input/scanned item
Loc From	<p>The prompting and behavior of this field is different for each of the three inventory transfer flavors.</p> <p>Validation:</p> <ul style="list-style-type: none"> • Location cannot be same as Loc From. • Location is valid for user/site. <p>Look-up Name: All locations for item</p> <p>Auto-display: No</p> <p>Default selected values: Location</p> <p>Look-up Query Rules:</p> <ul style="list-style-type: none"> • Locations per the user log-in site • Find/display first non-zero balance inventory locations per selected item number. <p>Note: Displays the location one time even though multiple ld_dets may exist and location type should not be an input.</p> <p>Look-up Fields:</p> <ul style="list-style-type: none"> • Location • QOH • Created • Zone (The Location Type field in Location Maintenance that defines the zone of the location) • Loc Stat

Field Name	Comments
Lot/Serial From	Only applicable when inventory in the From Location has lots. Otherwise, user is not prompted.
Reference From	Only applicable when inventory in the From Location has lots. Otherwise, user is not prompted. Field not mandatory when no Reference is tied to the lot/serial number.
Qty	Input quantity to transfer. Validation: Quantity is available to transfer; user cannot transfer more than available to transfer. When quantity not available, an error displays.
Loc To	Enter/select location to transfer item to. Validation: <ul style="list-style-type: none"> • Location cannot be same as Loc From • Location is valid for user/site Lookup Name: (Zone logic): Advanced Putaway Location Auto-display: Yes Default selected values: Location Current putaway logic directs users to put inventory into a warehouse location. Look-up Name: (Basic Zone logic): Putaway Locations (original version) <ul style="list-style-type: none"> • Putaway location • Auto-display: Yes • Default selected values: Location Look-up Query Rules: <ul style="list-style-type: none"> • Find/display non-zero balance inventory locations per selected item number where Location Type (loc_mstr.loc_type) = Zone Storage Location (pti_det.pti_site_loc) • Exclude locations of selected Location From • Find/display inventory locations with Location Type (loc_mstr.loc_type) = to Zone Storage Location (pti_det.pti_site_loc) per item site master where Zero balance, including locations where an ld_det record does not exist. Do not default Loc To value if selected from look-up Look-up Fields: <ul style="list-style-type: none"> • Look-up Name (Inspect Logic): MRB Locations • Look-up Name: MRB Locations Query Rules: <ul style="list-style-type: none"> • Display only locations where loc_mstr.loc_status = MRB • Do not default Loc To value when selected from look-up
Loc Zone	Per the selected Loc To value, display putaway (zone) per location maintenance location type loc_mstr.loc_type.
Review Before Commit	Any input entered completes the transaction. When data is incorrect, user should F4 back to correct it.

EAM Transactions

This chapter includes detailed technical information for the Automation Solutions: Data Collection EAM transactions.

Introduction 212

Inventory Transfer 212

Cycle Count 218

Physical 220

Purchase Requisitions 221

Stores Requisitions 224

Maintenance Reporting 225

Introduction

This chapter covers the following transactions:

- Relocate
- Part Lookup
- Part Labels
- Location Labels
- Adjust
- Count Physical Inventory
- PO Receipt
- Close Stores Requisitions
- Part Lookup
- Issue to WO
- Issue to Equipment
- Issue to Account
- Return Material

Inventory Transfer

Relocate

Transfer an item between locations.

Transaction Technical

DC Menu	DC Menu Name	DC Transaction Technical Name	Production Order .NET Menu Action
2.1.1.1	Inventory Transfer	Relocate	Trans: Inventory Transfer App: Inventory browse Relocate action

Primary Configuration

This transaction allows users to relocate or move stores inventory from one location to another.

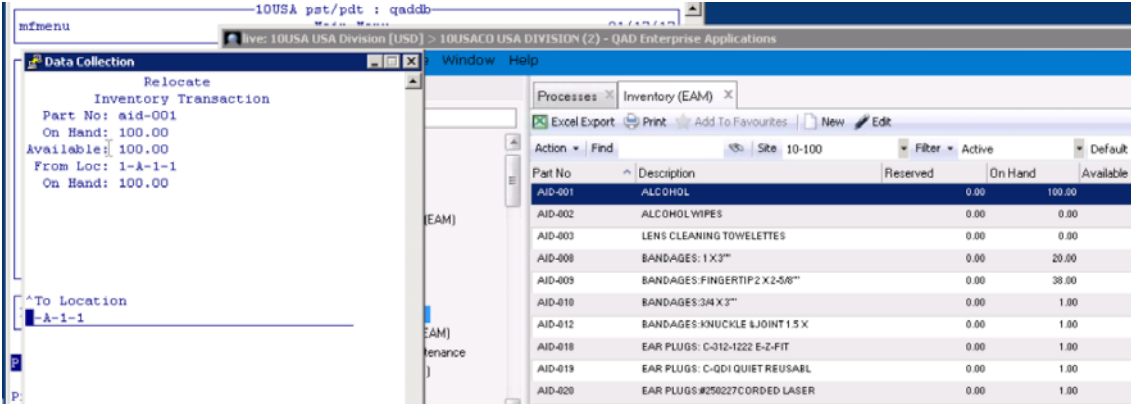

The system should process the transaction just like relocating a part from EAM, which includes updating inventory details and creating GL and inventory transactions and other required data.

Security for this transaction can be set up with the following steps:

- 1 Log in to EAM .NET.
- 2 Go to Role menu.
- 3 Select Inventory > Inventory > Inventory > Relocate.
- 4 Select Access value as required.
- 5 Save the record.

Limitations / Exceptions

- Does not support Consignment Parts.
- Does not support Serialized Parts.

Packaging Structures Supported

N/A

Field Information

Field Name	Comments
tt...	
WO No <i>(Data entry field)</i>	Type or scan in the Work Order number to which you are issuing inventory.
Part No <i>(Data entry field)</i>	Type or scan in the Part Number you are issuing from inventory.
From Loc <i>(Data entry field)</i>	Type in, scan in, or select location from which you are issuing this part.
Requestor	Read only. Defaults from the work order.

Field Name	Comments
On Hand	This read-only field displays to let you know how many of that part are in inventory at the specified location.
Quantity (Data entry field)	Enter the quantity of this part you are issuing.

Part Lookup

Search for a part record.

Transaction Technical

DC Menu	DC Menu Name	DC Transaction Technical Name	Production Order .NET Menu Action
2.1.1.20	Inventory Transfer	Part Lookup	Trans: Inventory search App: Inventory browse Find Field

Primary Configuration

This transaction allows you to check vital inventory information by part from the warehouse floor.

The screenshot shows a terminal-style window titled "Data Collection" with a sub-header "Part_Lookup". A "Parts" label is visible above the data. The data is as follows:

```

^Location: 1-A-1-11
On Hand L: 30.0
  On Hand: 99.0
  Reserved: 0.00
Available: 99.0
  Planned: 0.00
  On Order: 0.00
  Reorder: 10.
Min Order: 1.0
Safety St: .00
  Mgt Max: 11.
  Phy Due: 02/09/2017
  Last Phy: 02/10/2016
  Last Rec: 07/05/2009
  Last Iss: 01/27/2017
Next Part: es

```

This function displays various information such as inventory quantities, quantities in locations, stock information, and activity data.

The security for this transaction can be setup with the following:

- 1 Log in to EAM .NET.
- 2 Go to Role menu.

- 3 Select Inventory > Inventory > Inventory.
- 4 Select Access value as required.
- 5 Save the record.

Limitations / Exceptions

N/A

Packaging Structures Supported

N/A

Field Information

Field Name	Comments
tt...	
Part No (Data entry field)	Type or scan in the part number to be adjusted.
Desc	The part's description.
Location (Data entry field)	Type, scan in, or look up the part's inventory location.
On Hand L	The quantity for the part in the specified location.
On Hand	The total quantity for the part.
Reserved	The total quantity of the part reserved on stores requisitions.
Available	The total quantity on-hand minus the quantity on reserve.
Planned	The planned order quantity for this part. It represents all requisitions with a status of P (planned).
On Order	The total quantities of the part from all purchase orders with that item listed. It represents all purchase orders with a status of O (ordered).
Reorder	The quantity at which to reorder the part.
Min Order	The designated minimum order quantity.
Safety St	The minimum quantity to keep on hand for the part.
Mgt Max	The optimal amount to stock through stock replenishment, a quantity pre-set by management.
Phy Due	The date of the next required physical inventory.
Last Phy	The date of the last physical cycle count for the part.
Last Rec	The date the part was last received from a purchase order.
Last Iss	The date when this part was last issued.
Next Part (Data entry field)	Enter yes if you want to check details of another part; else enter no to go to menu.

Part Labels

Print labels for an item that contains item information.

Note This transaction is be available only if Label Printing Services (LPS) is installed.

Transaction Technical

DC Menu	DC Menu Name	DC Transaction Technical Name	Production Order .NET Menu Action
2.1.1.30	Inventory Transfer	Part Label	Trans: EAM Part Labels

Primary Configuration

This transaction allows you print part labels.

```

Part Labels
-----
Begin: █
End:
Copies: 1
-----
F4-Back F12-Abort
  
```

Part Labels are printed by part or by a range of parts. To print labels for only one part, enter that same part in both fields.

The security for this transaction can be set up with the following steps:

- 1 Log in to EAM .NET.
- 2 Go to Role menu.
- 3 Inventory > Inventory > Inventory > Label Print.
- 4 Select Access value as required.
- 5 Save the record.

Limitations / Exceptions

Do not allow printing of more than 99999 part labels for a particular part.

Packaging Structures Supported

N/A

Field Information

Field Name	Comments
tt...	
Begin <i>(Data entry field)</i>	Enter, scan in or select from the look-up the value of beginning part.
End <i>(Data entry field)</i>	Enter, scan in or select from the look-up the value of ending part.
Copies <i>(Data entry field)</i>	Type in the number of copies to be printed.

Location Labels

Print labels for an item that contains location information.

Note This transaction is available only if Label Printing Services (LPS) is installed.

Transaction Technical

DC Menu	DC Menu Name	DC Transaction Technical Name	Production Order .NET Menu Action
2.1.1.31	Inventory Transfer	Location Labels	Trans: Bin Labels

Primary Configuration

This transaction allows you print location labels.



Location Labels are printed by location or by a range of locations.

To print labels for only one location, enter that same location in both fields.

The security for this transaction can be set up with the following steps:

- 1 Log in to EAM .NET.
- 2 Go to Role menu.

- 3 Inventory > Codes > Part > Part Locations > Label Print.
- 4 Select Access value as required.
- 5 Save the record.

Limitations / Exceptions

- Does not support Consignment Parts.
- Does not support Serialized Parts.
- Does not allow users to print 99 or more location labels for a particular location.

Packaging Structures Supported

N/A

Field Information

Field Name	Comments
tt...	
Begin <i>(Data entry field)</i>	Enter, scan in or select from the look-up the value of beginning location.
End <i>(Data entry field)</i>	Enter, scan in or select from the look-up the value of ending location.
Copies <i>(Data entry field)</i>	Type in the number of copies to be printed.

Cycle Count

Adjust

Adjust on hand quantity for a part location.

Transaction Technical

DC Menu	DC Menu Name	DC Transaction Technical Name	Production Order .NET Menu Action
2.1.5.1	Cycle Count	Adjust	Trans: Adjust App: Inventory browse Inventory Action

Primary Configuration

This transactions allows users to conduct on-the-spot inventory adjustments.

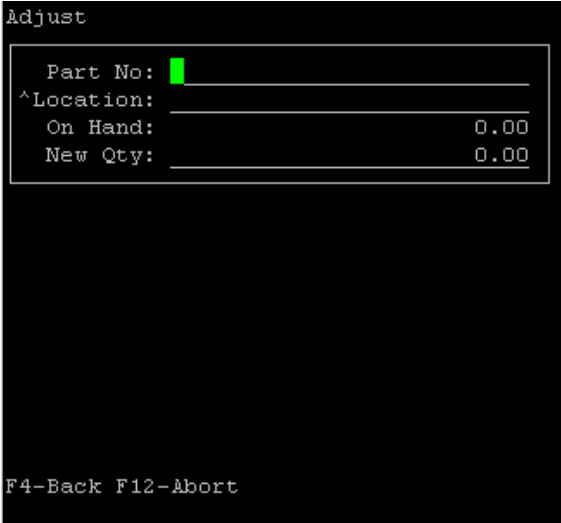

Usually, the Adjust function is appropriate for occasional spot checks of stores inventory. Use the Physical Inventory function for a more formal inventory count.

The system should process the transaction just like adjusting a part from EAM. This includes updating inventory details, creating GL and inventory transactions, and other required data.

The security for this transaction can be set up with the following steps:

- 1 Log in to EAM .NET.
- 2 Go to Role menu.
- 3 Select Inventory > Inventory > Inventory > Adjust.
- 4 Select Access value as required.
- 5 Save the record.

Limitations / Exceptions

- Does not support Consignment Parts.
- Does not support Serialized Parts.

Packaging Structures Supported

N/A

Field Information

Field Name	Comments
tt...	
Part No <i>(Data entry field)</i>	Type or scan in the part number to be adjusted.

Field Name	Comments
Location <i>(Data entry field)</i>	Type, scan in, or look up the part's inventory location.
On Hand	The quantity for the part in the specified location.
New Qty <i>(Data entry field)</i>	Enter the actual quantity counted for the part in the specified location.

Physical

Count Physical Inventory

Record count for a part and its location.

Transaction Technical

DC Menu	DC Menu Name	DC Transaction Technical Name	Production Order .NET Menu Action
2.1.7.1	Physical	Count Physical Inventory	Trans: Count Physical Inventory App: Inventory Physical Inventory

Primary Configuration

This transaction allows the use of the RF portable unit and the reading of barcodes to conduct physical inventory counts. The portability of the RF unit lets the count be recorded in real-time, at the point of the count. The use of barcodes reduces the potential for data entry errors. In general, your physical counts are more accurate and less time consuming.

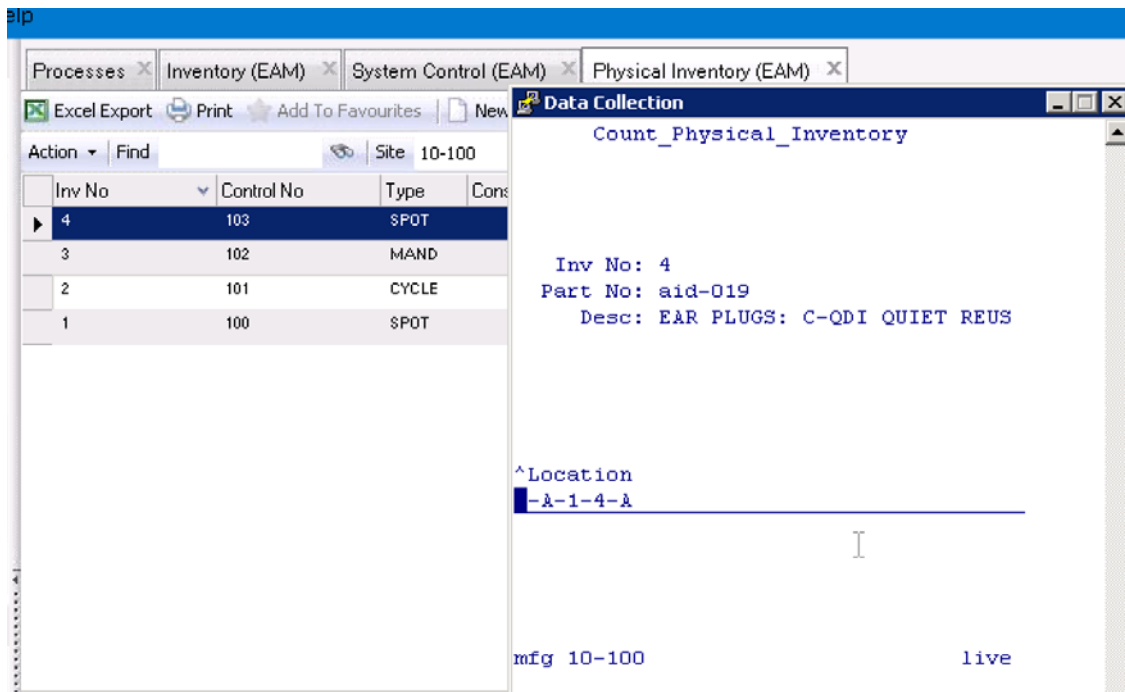

In order to conduct a physical inventory count, the Physical Inventory must be set up in advance in EAM.

The Physical Inventories are site specific, so you must be logged into the same site as specified on the Physical Inventory in order to count against it.

The Physical Inventory must be open (not closed or canceled) for you to count against it.

The security for this transaction can be set up with the following steps:

- 1 Log in to EAM .NET.
- 2 Go to Role menu.
- 3 Inventory > Physical Inventory > Physical Inventory (lower browse) > Edit.
- 4 Select Access value as required.
- 5 Save the record

Limitations / Exceptions

N/A

Packaging Structures Supported

N/A

Field Information

Field Name	Comments
tt...	
Inv No <i>(Data entry field)</i>	Type or scan in the Physical Inventory Count number. This unique number identifies the set of parts to be counted. The physical inventory number must be neither Closed nor Cancelled.
Part No <i>(Data entry field)</i>	The part number which may be entered, scanned, or selected. The look-up should only list the parts that exist in the Physical Inventory.
Desc	The part's description.
Location	The location for the physical inventory coun; it should be a location set within the physical inventory.
Curr Qty	The on-hand quantity for the part in the specified location.
Count <i>(Data entry field)</i>	Enter the actual quantity counted for this part in this location.

Purchase Requisitions

PO Receipt

Receive items against a purchase order.

Transaction Technical

DC Menu	DC Menu Name	DC Transaction Technical Name	Production Order .NET Menu Action
2.2.1.1	Purchase Requisitions	PO Receipt	Trans: PO Receipt App: Purchase Order browse Receive Action

Primary Configuration

This transaction allows items ordered on a purchase order to be received into stores or auto-issued using a hand-held device.

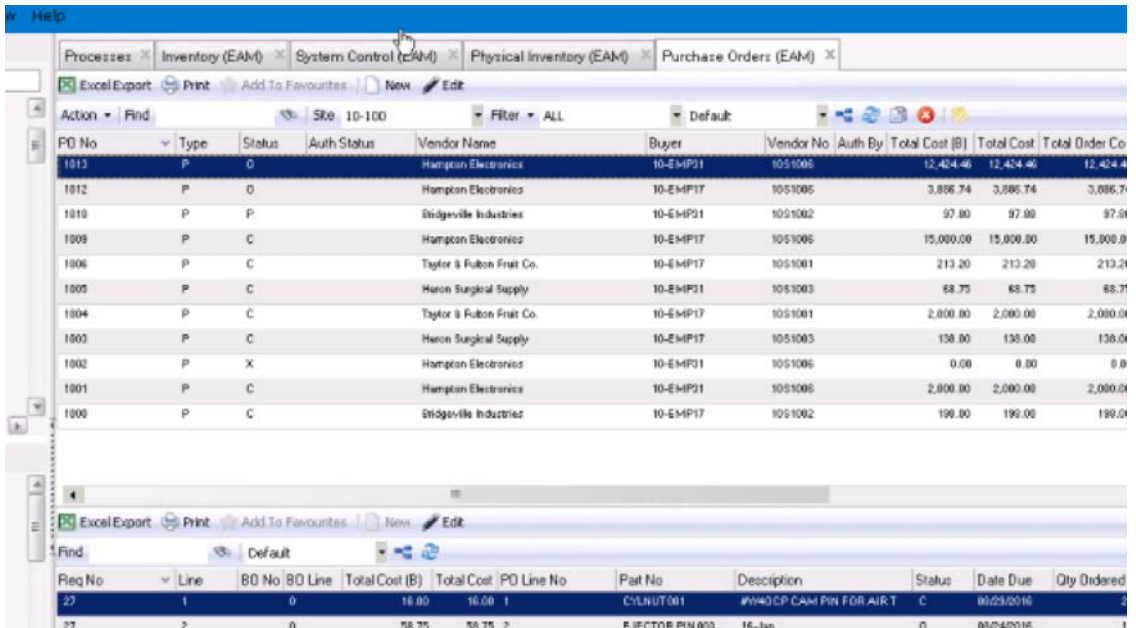
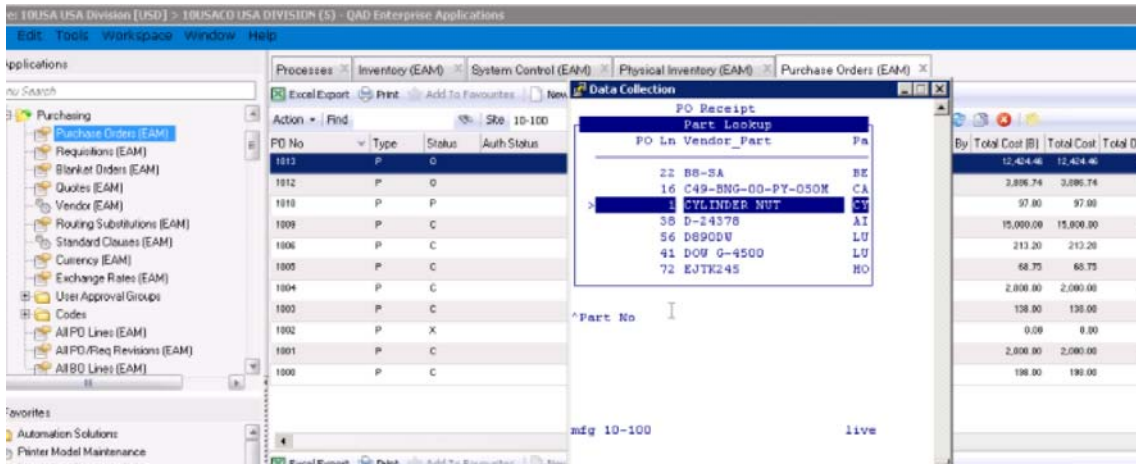

The Purchase Order must not be closed or canceled.

The Purchase Order must be on Order.

The system processes the transaction just like receiving a part from EAM, which includes updating inventory details and purchase order line details and creating GL and inventory transactions and other required data.

The security for this transaction can be set up with the following steps:

- 1 Log in to EAM .NET.
- 2 Go to Role menu.
- 3 Purchasing > Purchase Orders > Purchase Orders > Receive.
- 4 Select Access value as required.
- 5 Save the record.

Limitations / Exceptions

- Does not support Consignment Parts.
- Does not support Serialized Parts.
- Not supported if Channel Islands Fixed Assets installed.

Packaging Structures Supported

N/A

Field Information

Field Name	Comments
tt...	
PO No <i>(Data entry field)</i>	Type or scan the PO number you are receiving items against.
Pack Slip <i>(Data entry field)</i>	Type or scan the packing slip number you are receiving items against.
Rec Date	Receipt Date - defaults to today and cannot be greater than today.
Ship Date	Shipment date - defaults to today
tt... - PO Receipt - Lines	
PO No	The purchase order number that was derived from the prior screen.
Part No	This is the Part Number associated to the specified order.
Desc	The item's description.
PO Line <i>(Data entry field)</i>	Enter or select PO Line number if the PO has multiple lines with same Part No. Fields (vendor part, order qty, open qty, rec qty, UOM, location) on the screen should be refreshed after this is changed.
VPN	The vendor part number.
Order Qty	The quantity ordered on the purchase order.
Open Qty	The quantity that has not yet been received.
Rec Qty	The quantity to be received. This defaults to the open quantity.
UOM	Unit of measure for the parts quantity.

Field Name	Comments
Location (Data entry field)	Enter, scan in, or select location code for the part to be received to. This defaults from the purchase order line. This value is updated once the Part or PO line has been changed.
Print Lbl (Data entry field)	Is a part label to be produced for this receipt? This value defaults from the site default value. This field will be available only if LPS is installed.
Label Qty (Data entry field)	The number of labels to be produced. This defaults to the open quantity value. This field will be available only if LPS is installed.
Cncl Qty (Data entry field)	The quantity to be canceled.

Stores Requisitions

Close Stores Requisitions

Change Stores Requisition status.

Transaction Technical

DC Menu	DC Menu Name	DC Transaction Technical Name	Production Order .NET Menu Action
2.3.2	Stores Requisitions	Close Stores Requisition	Trans: Close Stores Requisition App: Inventory Stores Requisition Change Status Action

Primary Configuration

This transaction allows you to change the status of an open Stores Requisition to C (Closed). The system only allows closing an open stores requisition.

This function is useful if there are items remaining that will not be issued on a stores requisition and the stores requisition should be closed anyway.

The security for this transaction can be set up with the following steps:

- 1 Log in to EAM .NET.
- 2 Go to Role menu.
- 3 Inventory > Stores Requisition Lists > Stores Requisition Lists > Change Status.
- 4 Select Access value as required.
- 5 Save the record.

Limitations / Exceptions

N/A

Packaging Structures Supported

N/A

Field Information

Field Name	Comments
tt...	
St Req No (Data entry field)	Type or scan in the Stores Requisition Number you want to close.

Part Lookup

Look up a part to include on a Stores Requisition List.

Note For detailed transaction information, see “Part Lookup” on page 214.

Transaction Technical

DC Menu	DC Menu Name	DC Transaction Technical Name	Production Order .NET Menu Action
2.3.3	Stores Requisitions	Part Lookup	Trans: Inventory lookup App: Inventory Stores Requisition Second browse New Part Lookup

Maintenance Reporting

Issue to WO

Issue a part to a work order.

Transaction Technical

DC Menu	DC Menu Name	DC Transaction Technical Name	Production Order .NET Menu Action
2.5.1.1	Maintenance Reporting	Issue to WO	Trans: Issue to WO App: Inventory Browse Issue Action Enter work order number

Primary Configuration

This transaction allows inventory parts to be issued to an existing open work order.

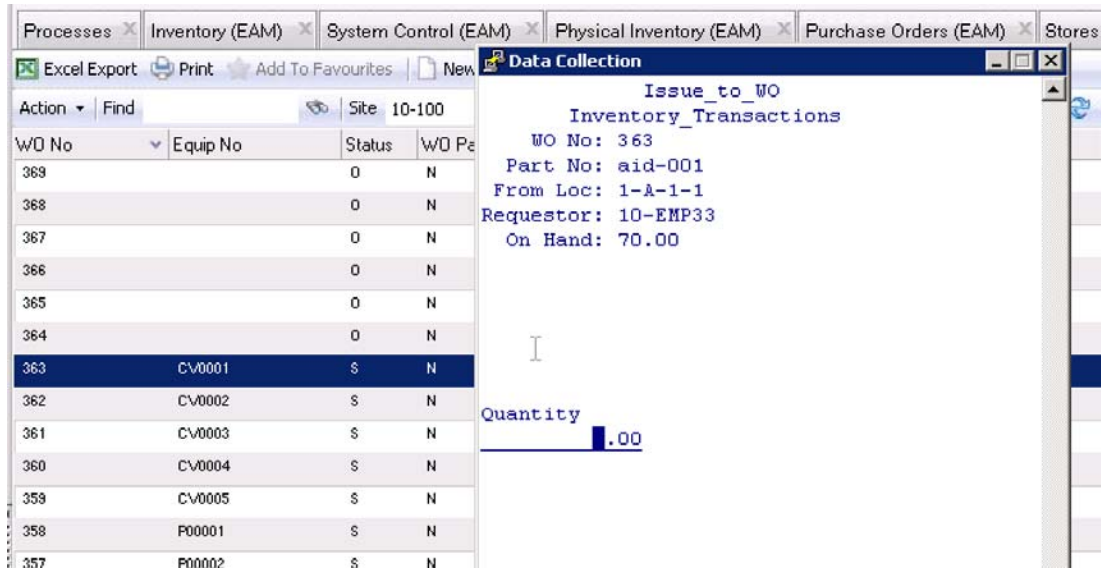

Verified costs on WO

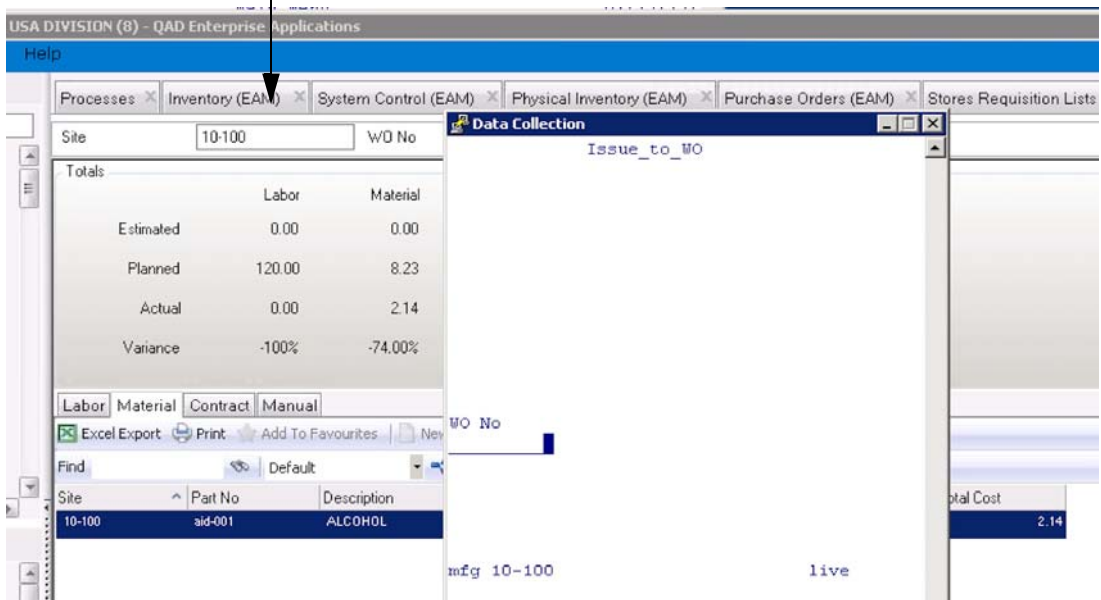

The system should process the transaction just like issuing a part from EAM, which includes updating inventory details and creating the appropriate General Ledger and inventory transactions and other required data.

The security for this transaction can be set up with the following steps:

- 1 Log in to EAM .NET.
- 2 Go to Role menu.
- 3 Select Maintenance > Work Orders > Work Orders > Issue.
- 4 Select Access value as required.

5 Save the record.

Limitations / Exceptions

- Does not support Consignment Parts.
- Does not support Serialized Parts.
- Does not support issue parts across site.

Packaging Structures Supported

N/A

Field Information

Field Name	Comments
tt...	
WO No <i>(Data entry field)</i>	Type or scan in the Work Order number to which you are issuing inventory.
Part No <i>(Data entry field)</i>	Type or scan in the Part Number you are issuing from inventory.
From Loc <i>(Data entry field)</i>	Type in, scan in, or select location from which you are issuing this part.
Requestor	Read only. Defaults from the work order.
On Hand	This read-only field displays to let you know how many of that part are in inventory at the specified location.
Quantity <i>(Data entry field)</i>	Enter the quantity of this part you are issuing.

Issue to Equipment

Issue a part to a piece of equipment.

Transaction Technical

DC Menu	DC Menu Name	DC Transaction Technical Name	Production Order .NET Menu Action
2.5.1.2	Maintenance Reporting	Issue to Equipment	Trans: Issue to Equipment App: Inventory Browse Issue Action Enter equipment number

Primary Configuration

This transaction allows inventory parts to be issued to a specific piece of equipment.

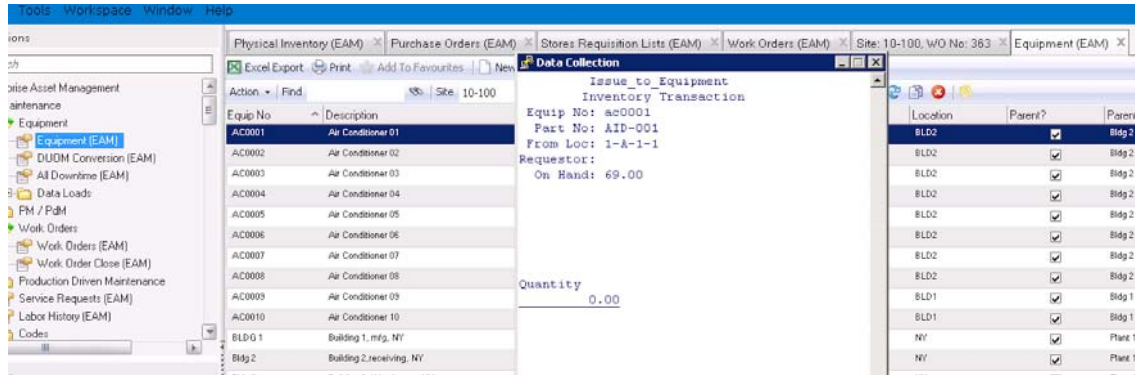

The Equipment you specify must be “Unlocked”.

The system should process the transaction just like issuing a part from EAM. This includes updating inventory details, creating GLs, inventory transactions and other required data.

The security for this transaction can be set up with the following steps:

- 1 Log in to EAM .NET.
- 2 Go to Role menu.
- 3 Select Inventory > Inventory > Inventory > Issue.
- 4 Select Access value as required.
- 5 Save the record.

Limitations / Exceptions

- Does not support Consignment Parts.
- Does not support Serialized Parts.
- Does not support issue parts across site.

Packaging Structures Supported

N/A

Field Information

Field Name	Comments
tt...	
Equip No <i>(Data entry field)</i>	Enter or scan in the Equipment number to which you are issuing inventory.
Part No <i>(Data entry field)</i>	Type or scan in the Part Number you are issuing from inventory.
From Loc <i>(Data entry field)</i>	Type in, scan in, or select location from which you are issuing this part.

Field Name	Comments
Requestor	Read only. Defaults to the login user's employee ID if the login user's employee is a valid employee in the login site.
On Hand	This read only field displays to let you know how many of that part are in inventory at the specified location.
Quantity (Data entry field)	Enter the quantity of this part you are issuing.

Issue to Account

Issue a part to a Cost Center/Account/Sub Account.

Transaction Technical

DC Menu	DC Menu Name	DC Transaction Technical Name	Production Order .NET Menu Action
2.5.1.4	Maintenance Reporting	Issue to Account	Trans: Issue to Account App: Inventory Browse Issue Action Enter cc/acct/sub account number

Primary Configuration

This transaction allows inventory parts to be issued to an individual or combination of Cost Center and Account Number or issued to the Expense accounting structure combination defined for the part being issued.

The Cost Center and /or Account must be "Active".

The system should process the transaction just like issuing a part from EAM, which includes updating inventory details and creating GL and inventory transactions and other required data.

The security for this transaction can be set up the following steps:

- 1 Log in to EAM .NET.
- 2 Go to Role menu.
- 3 Select Inventory > Inventory > Inventory > Issue.
- 4 Select Access value as required.
- 5 Save the record.

Limitations / Exceptions

- Does not support Consignment Parts.
- Does not support Serialized Parts.

Packaging Structures Supported

N/A

Field Information

Field Name	Comments
tt...	
Part No <i>(Data entry field)</i>	Type or scan in the Part Number you are issuing from inventory.
From Loc <i>(Data entry field)</i>	Type in, scan in, or select location from which you are issuing this part.
Requestor	Defaults to the login user's employee ID if the login user's employee is a valid employee in the login site.
On Hand	This read only field displays to let you know how many of that part are in inventory at the specified location.
Exp Site	For the Exp Site/Dept/CC/Acct No/Sub Acct fields: The combination defaults to the part's primary expense Account if it exists; otherwise defaults to the part's site Inventory Issue Defaults - Debit. This field allows for cross-site issues. Typically this is your own site.
Dept <i>(Data entry field)</i>	Type, scan in, or select Department you are issuing this part to.
CC <i>(Data entry field)</i>	Type, scan in, or select Cost Center you are issuing this part to.
Acct No <i>(Data entry field)</i>	Type, scan in, or select Account Number you are issuing this part to. When the Acct No is changed, the Sub Acct No is blanked out if it is not valid with the new Acct No.
Sub Acct <i>(Data entry field)</i>	Type, scan in, or select Sub Account Number you are issuing this part to.
Quantity <i>(Data entry field)</i>	Enter the quantity of this part you are issuing.

Return Material

Return a part to Inventory.

Transaction Technical

DC Menu	DC Menu Name	DC Transaction Technical Name	Production Order .NET Menu Action
2.5.1.5	Maintenance Reporting	Return Material	Trans: Return App: Inventory Browse Return Action

Primary Configuration

The Return function may be better thought of as the “Return from Issue” function.

This transactions allows previously issued inventory to be returned and reverses the associated financial transaction. Any of the types of issues processed through EAM Barcode may be reversed through this Return function.

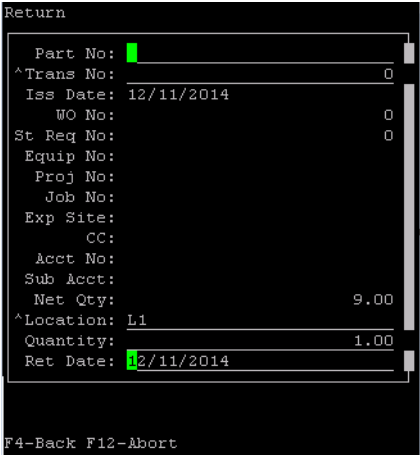

The system should process the transaction just like returning a part from EAM, which includes updating inventory details and creating GL and inventory transactions and other required data.

The security for this transaction can be set up with the following steps:

- 1 Log in to EAM .NET.
- 2 Go to Role menu.
- 3 Select Inventory > Inventory > Inventory > Return to Inventory.
- 4 Select Access value as required.
- 5 Save the record.

Limitations / Exceptions

- Does not support Consignment Parts.
- Does not support Serialized Parts.

Packaging Structures Supported

N/A

Field Information

Field Name	Comments
tt...	
Part No <i>(Data entry field)</i>	Type or scan in the Part Number being returned from issue.
Trans No <i>(Data entry field)</i>	Type or select from look-up the value of Issue Transaction Number.
Iss Date	Read only. Date on which the part was issued.
WO No	Read only. Work Order Number used while issuing this part.
St Req No	Read only. Stores Requisition Number used while issuing this part.

Field Name	Comments
Equip No	Read only. Equipment Number used while issuing this part.
Proj No	Read only. Project Number used while issuing this part.
Exp Site	Read only. Expense Site used while issuing this part.
CC	Read only. Cost Center used while issuing this part.
Acct No	Read only. Account Number used while issuing this part.
Sub Acct	Read only. Sub Account Number used while issuing this part.
Net Qty	Read only. The quantity remaining to be returned. If previous returns have been processed against this transaction, the system calculates Net Quantity as equal to the Original Qty – Qty Already Returned.
Location <i>(Data entry field)</i>	This is the stores location into which you are placing the returned quantity of parts.
Quantity <i>(Data entry field)</i>	The quantity of this part being returned. This quantity can not exceed the original quantity issued or the net quantity to return. - Defaults to Net Qty Issued.
Ret Date <i>(Data entry field)</i>	Date Returned - Defaults to today.

Installation Instructions

This chapter discusses how to install Automation Solutions: Data Collection transactions:

Installing Data Collection Transactions and Menus 2

Installing Data Collection Transactions and Menus

Artifact Location

The `as-setup` folder, which is located in the `${DIST}` directory, contains all the transactions and menu files that are used to configure Data Collection transactions.

The transaction `.xml` or `.zip` file are located in:

```
${DIST}/as-setup/transactions/<App>/<module> directory
```

The menu `.xml` file is located in:

```
${DIST}/as-setup/menus/<App> directory
```

Importing Transactions and Menus

Important When importing Data Collection transactions and menus, you must import transactions before importing menus.

The following section describes how to import the transactions and transaction menus into Data Collection.

Log in to QAD EE environment and perform the following steps:

- 1 Open Application Version Maintenance (6.22.2) and create a new record for the application version.

Note This step is only applicable if you are using Data Collection v3.0 or earlier. Skip this step if you are importing the transactions and menus into Data Collection v3.1 or later.

Fig. 7.1
Application Version Maintenance

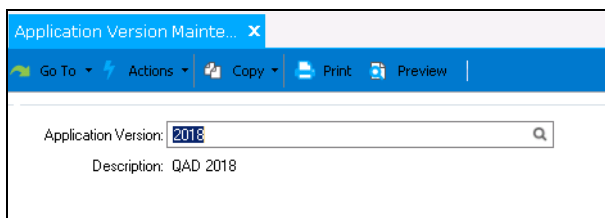

- 2 Open Transaction Definition Import/Export (6.23.4) and enter the following information to load the DC transactions into the system:

Field	Setting
Import/Export	Import
Directory	$\${DIST}$ /as-setup/transactions/<App>/<Module>/ For example, the transaction directories are as follows: EE transactions: <ul style="list-style-type: none"> • $\\${appdir}$/dist/as-setup/transactions/erp/inbound/ • $\\${appdir}$/dist/as-setup/transactions/erp/outbound/ • $\\${appdir}$/dist/as-setup/transactions/erp/inventory/ EAM transactions: <ul style="list-style-type: none"> • $\\${appdir}$/dist/as-setup/transactions/eam/ Production Orders transactions: <ul style="list-style-type: none"> • $\\${appdir}$/dist/as-setup/transactions//productionorder/
File Mask	*.xml (Specify to show all transaction .xml files)
Select All	Yes
Delete	No (This will be inactive for the import function.)

Fig. 7.2
Importing DC Transactions

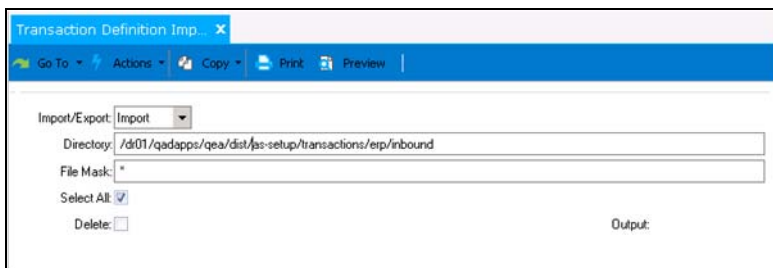

- Once you have entered everything in Transaction Definition Import/Export, click Next. The following window appears showing the transactions that will be imported.

Note If you selected the Select All check box in the previous screen, all these fields will be set to Yes. If you do not want to import a specific transaction, set the field to No.

4 QAD Data Collection Transactions User Guide

Fig. 7.3
Importing DC Transactions

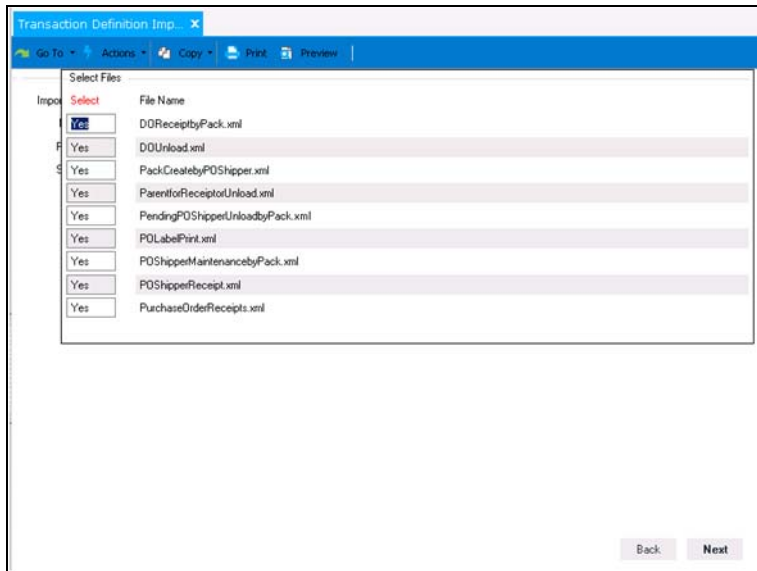

- 4 Click Next to view the Transaction Definition Import/Export report.

Fig. 7.4
Importing DC Transactions

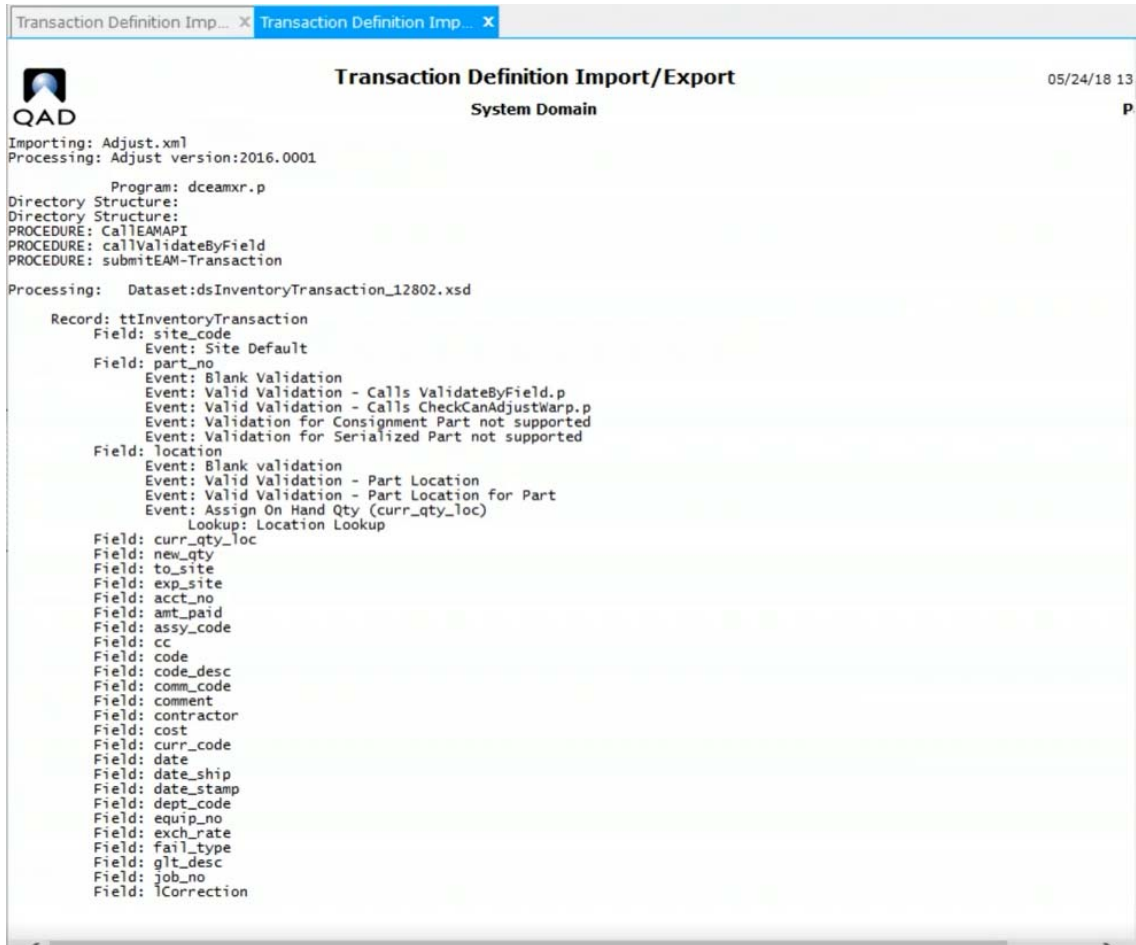

- 5 Repeat steps 2 through 4 to import additional transactions.
- 6 Once you have imported all the necessary Data Collection transactions, open Process Category Import Export (6.23.1) to import the Data Collection menus. Enter the following information in the fields:

Field	Setting
Import/Export	Import
Directory	$\${DIST} / as-setup/menus / <App> /$ For example, the menu directories are as follows: EE menus: <ul style="list-style-type: none"> • $\\${appdir} / dist/as-setup/menus/erp/$ EAM menus: <ul style="list-style-type: none"> • $\\${appdir} / dist/as-setup/menus/eam/$ Production Order menus: <ul style="list-style-type: none"> • $\\${appdir} / dist/as-setup/menus/productionorder/$
File Mask	*.xml (Specify to show all transaction .xml files)
Select All	Yes
Overwrite Existing	Yes (If the menus are already available, selecting Yes will overwrite them.)

6 QAD Data Collection Transactions User Guide

Fig. 7.5
Importing DC Transaction Menus

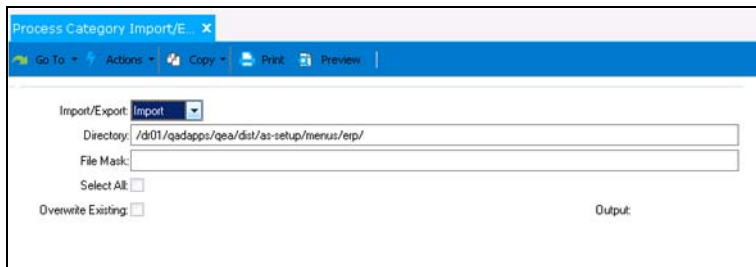

The screenshot shows the 'Process Category Import/E...' dialog box. It has a blue header bar with 'Go To', 'Actions', 'Copy', 'Print', and 'Preview' buttons. Below the header, there is a dropdown menu for 'Import/Export' set to 'Import'. A text field for 'Directory' contains '/d01/qadapps/qea/dist/as-setup/menus/erp/'. A 'File Mask' field is empty. There are three checkboxes: 'Select All' (unchecked), 'Overwrite Existing' (unchecked), and 'Output' (unchecked).

- 7 Once you have entered everything in Process Category Import/Export, click Next. The following window appears showing the menus that will be imported.

Note If you selected the Select All check box in the previous screen, all these fields will be set to Yes. If you do not want to import a specific menu, set the field to No.

Fig. 7.6
Importing DC Menus



The screenshot shows the 'Process Category Import/E...' dialog box with the 'Select Files' section expanded. It displays a table with columns for 'Select' and 'File Name'. The 'Select' column has three radio buttons, all of which are selected. The 'File Name' column lists 'Inbound.xml', 'Inventory.xml', and 'Outbound.xml'. Below the table, there is a 'Dive' button.

Select	File Name
<input checked="" type="radio"/>	Inbound.xml
<input checked="" type="radio"/>	Inventory.xml
<input checked="" type="radio"/>	Outbound.xml

- 8 Click Next to view the Process Category Import/Export report.

Fig. 7.7
Importing DC Menus

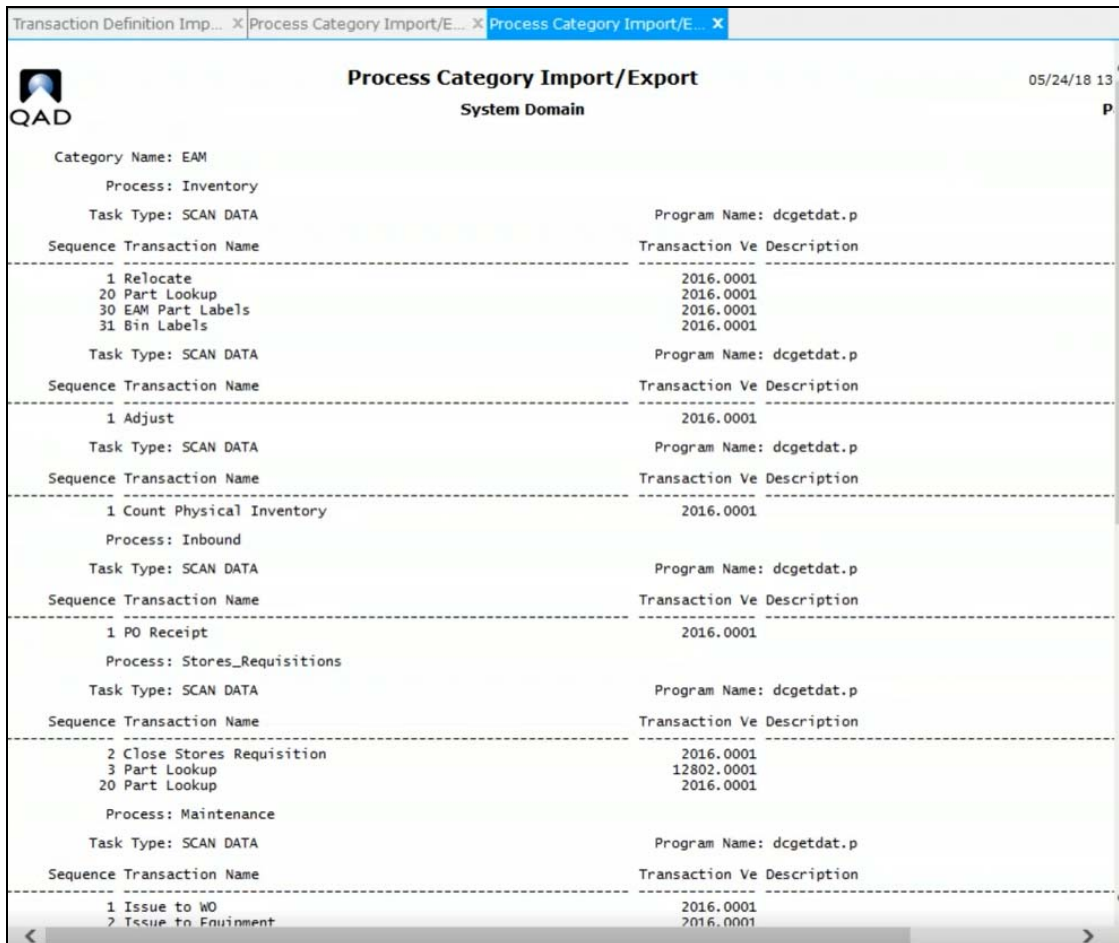

9 Repeat steps 6 through 8 to import additional menus.

Verify Installation

Open Transaction Definition Maintenance (6.16) and verify the Data Collection transactions and menus were installed correctly. Select the Transaction Name lookup and verify the transactions that you installed are listed.

Fig. 7.8
Verify Installation

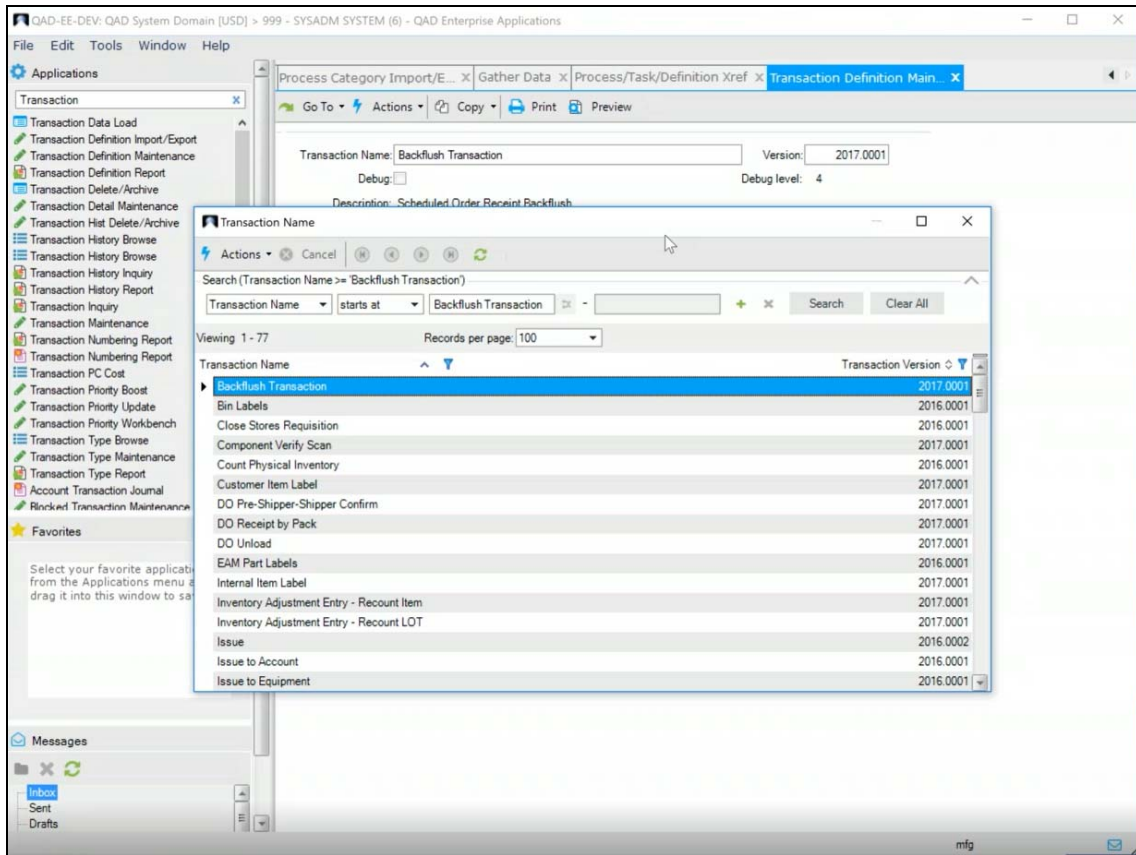

Product Information Resources

QAD offers a number of online resources to help you get more information about using QAD products.

[QAD Forums \(community.qad.com\)](https://community.qad.com)

Ask questions and share information with other members of the user community, including QAD experts.

[QAD Knowledgebase \(knowledgebase.qad.com\)*](https://knowledgebase.qad.com)

Search for answers, tips, or solutions related to any QAD product or topic.

[QAD Document Library \(documentlibrary.qad.com\)](https://documentlibrary.qad.com)

Get browser-based access to user guides, release notes, training guides, and so on; use powerful search features to find the document you want, then read online, or download and print PDF.

[QAD Learning Center \(learning.qad.com\)*](https://learning.qad.com)

Visit QAD's one-stop destination for all courses and training materials.

*Log-in required

